

AUTHORITY	DESCRIPTION	DATE	
RFC-00413	Incorporation of IRN-IS-800G-001 and IRN-IS-800G-002	13-APR-2021	
<p>DISTRIBUTION STATEMENT A. Approved for public release; distribution is unlimited</p>			
<p>APPROVALS</p>			
<p>Authored By: Anthony Flores</p>		<p>Checked By: Kevin Cano</p>	
AUTHORIZED SIGNATURES	REPRESENTING	DATE	
<p>DUNN.MICHAEL.J. 1171235045</p> <p><small>Digitally signed by DUNN.MICHAEL.J.1171235045 Date: 2021.05.21 14:55:22 -07'00'</small></p>	<p>PNT Capability Area Integration, Portfolio Architect Space and Missile Systems Center – LAAFB</p>	<p>21 May 2021</p>	
<p>INTERFACE SPECIFICATION</p>			
<p>UNLESS OTHERWISE SPECIFIED NUMBERS ARE REPRESENTED IN DECIMAL FORM..</p>	<p>Interface Control Contractor: SAIC (GPS SE&I) 200 N. Pacific Coast Highway, Suite 1800 El Segundo, CA 90245</p>		
<p>THIS DOCUMENT SPECIFIES TECHNICAL REQUIREMENTS AND NOTHING HEREIN CONTAINED SHALL BE DEEMED TO ALTER THE TERMS OF ANY CONTRACT OR PURCHASE ORDER BETWEEN ALL PARTIES AFFECTED</p>	<p>TITLE: NAVSTAR GPS Space Segment/ User Segment L1C Interfaces</p>		
	<p>SIZE A</p>	<p>CODE IDENT 66RP1</p>	<p>DOC NO. IS-GPS-800</p>
	<p>SCALE: N/A</p>	<p>REV: H</p>	

REVISION RECORD			
REVISION	DESCRIPTION	DOC DATE	APPROVED
NC	Initial Release	24 Nov 2003	24 Nov 2003
A	Incorporates Phase Variance language revision, attitude error from coverage angle specifications, addition of Space Service Volume (SSV) language, and addition of Integrity Flag description language	8 Jun 2010	08 Jun 2010
N/A	SE&I Tech Pubs	29 Jul 2010	
B	IRN-IS-800A-001; RFC-16B Pseudorandom Noise (PRN) Expansion IRN-IS-800A-002; RFC-77B Public Document Management (GPS III terminology and Space Service Volume (SSV) group delay IRN-IS-800A-003; RFC-86 User Range Accuracy (URA) Definition IRN-IS-800A-004; RFC-93 Technical Note 36 IRN-IS-800A-005; RFC-97 Pseudorange Parameters	21 Sep 2011	08 Dec 2011
C	IRN-IS-800B-001 IRN-IS-800B-002; RFC-139B Public Signals-in-Space Updates IRN-IS-800B-003; RFC-118 L1C Phase Noise	05 Sep 2012	31 Jan 2013
D	IRN-IS-800C-001; RFC-183A L1C Data Predict Week Number (WNop) IRN-IS-800C-002; RFV-188B Public Signals in Space Requirements Disconnects IRN-IS-800C-003; RFC-193 CNAV Reference Times IRN-IS-800C-004; RFC-198 PRNs 211-1023 Mission Assignments	24 Sep 2013	21 Mar 2014
E	IRN-IS-800D-001; RFC-267 L5 and L1C Phase Noise Plot IRN-IS-800D-002; RFC-268 Incorrect CNAV-2 Message Structure Reference for IAURANED Parameters IRN-IS-800D-003; RFC-312 Definition Clarification for Time of Predict IRN-IS-800D-004A; RFC-318 2016 Public Document Clean-Up IRN-IS-800D-004A; RFC-318 2016 Public Document Clean-Up	25 Apr 2018	22 May 2018
F	IRN-IS-800E-001 (RFC-374 – 2018 Public Document Proposed Changes)	04 Mar 2019	06 May 2019

REVISION RECORD			
REVISION	DESCRIPTION	DOC DATE	APPROVED
G	IRN-IS-800F-001; RFC-400 Leap Second and Earth Orientation Parameters) IRN-IS-800F-002; RFC-395 2018 Public Document Proposed Changes IRN-IS-800F-003; RFC-403 Health Bit Clarification IRN-IS-800F-004; RFC-403 Health Bit Clarification	14 May 2020	03 Aug 2020
H	Incorporates the following approved IRNs: IRN-IS-800G-001 - RFC442 IRN-IS-800G-002 - RFC413	13 Apr 2021	21 May 2021

TABLE OF CONTENTS

1 INTRODUCTION	1
1.1 Scope.....	1
1.2 Interface Definition.....	1
1.3 IS Approval and Changes	1
2 APPLICABLE DOCUMENTS	2
2.1 Applicable Documents.....	2
2.2 Reference Documents	2
3 SIGNAL REQUIREMENTS	3
3.1 Signal Structure.....	3
3.2 Signal Definition.....	3
3.2.1 Signal Characteristics.....	3
3.2.1.1 Frequency Plan.....	4
3.2.1.2 Signal Polarization	4
3.2.1.3 Carrier Phase Noise.....	4
3.2.1.4 Spurious Transmissions	4
3.2.1.5 Correlation Loss.....	4
3.2.1.6 Signal Component Phasing	5
3.2.1.6.1 Phase Relationship.....	5
3.2.1.6.2 Phase Continuity	5
3.2.1.7 Signal Characteristics.....	5
3.2.1.7.1 Signal Coherence	5
3.2.1.7.2 Signal Distortion	5
3.2.1.8 Equipment Group Delay	6
3.2.1.8.1 Group Delay Uncertainty.....	6
3.2.1.8.2 Group Delay Differential	6
3.2.1.8.3 Space Service Volume (SSV) Group Delay Differential.....	6
3.2.1.9 Signal Power Levels	6
3.2.2 PRN Code Characteristics.....	7
3.2.2.1 L1C Codes	7

3.2.2.1.1 Ranging Code Structure	8
3.2.2.1.2 Overlay Code Structure.....	9
3.2.2.2 Non-Standard Codes	18
3.2.3 Message Characteristics.....	18
3.2.3.1 L1C Message Structure.....	18
3.2.3.2 Time of Interval Data Encoding	19
3.2.3.3 Cyclic Redundancy Check.....	20
3.2.3.4 Low Density Parity Check (LDPC) Code.....	21
3.2.3.5 Interleaving	23
3.3 Signal Modulation.....	25
3.4 Interface Criteria	28
3.4.1 GPS Time.....	28
3.4.2 SV Time vs. GPS Time.....	28
3.4.3 Speed of Light.....	28
3.5 Message Definition	29
3.5.1 Message Content.....	29
3.5.2 Subframe 1	29
3.5.3 Subframe 2.....	39
3.5.3.1 Transmission Week Number.....	42
3.5.3.2 ITOW	43
3.5.3.3 CEI Data Sequence Propagation Time of Week.....	43
3.5.3.4 L1C Signal Health.....	43
3.5.3.5 SV Accuracy	44
3.5.3.6 Ephemeris Parameter Characteristics	46
3.5.3.6.1 User Algorithm for Determination of SV Position.....	46
3.5.3.7 Clock Parameter Characteristics	50
3.5.3.7.1 User Algorithms for SV Clock Correction Data.....	50
3.5.3.8 Non-Elevation Dependent (NED) Accuracy Estimates	51
3.5.3.9 Group Delay Correction Parameters	54
3.5.3.9.1 Inter-Signal Correction	54
3.5.3.9.2 L1/L2 Ionospheric Correction.....	55

3.5.3.9.3 L1/L5 Ionospheric Correction.....	55
3.5.3.10 Integrity Assurance	56
3.5.3.10.1 Integrity Status Flag (ISF)	56
3.5.3.11 CEI Data Sequence Propagation Week Number.	57
3.5.4 Subframe 3.....	57
3.5.4.1 Subframe 3, Page 1 - UTC & IONO.....	57
3.5.4.1.1 UTC Parameter Content.....	57
3.5.4.1.1.1 UTC and GPS Time	57
3.5.4.1.2 Ionospheric Data	59
3.5.4.2 Subframe 3, Page 2 - GGTO & EOP	59
3.5.4.2.1 GGTO Parameter Content.....	60
3.5.4.2.1.1 GPS and GNSS Time.....	60
3.5.4.2.2 EOP Content	61
3.5.4.2.3 User Algorithm for Application of the EOP	61
3.5.4.3 Subframe 3, Page 3 & Page 4 - Almanac.....	63
3.5.4.3.1 Almanac Reference Week.....	63
3.5.4.3.2 Almanac Reference Time	63
3.5.4.3.3 SV PRN Number.....	63
3.5.4.3.4 Signal Health (L1/L2/L5)	64
3.5.4.3.5 Reduced Almanac Data.....	64
3.5.4.3.5.1 Reduced Almanac Packet	64
3.5.4.3.5.1.1 Reduced Almanac	65
3.5.4.3.6 Midi Almanac Parameter Content	66
3.5.4.4 Subframe 3, Page 5 - Differential Correction	67
3.5.4.4.1 Differential Correction Parameter Content	67
3.5.4.4.2 Differential Correction Data Predict Time of Week	67
3.5.4.4.3 Time of Differential Correction Data	67
3.5.4.4.4 DC Data Packet.....	67
3.5.4.4.4.1 SV PRN Identification	68
3.5.4.4.4.2 Application of DC Data	68
3.5.4.5 Subframe 3, Page 6 - Text.....	69

3.5.4.6 Subframe 3, Page 7 - SV Configuration	70
3.5.4.7 Subframe 3, Page 8- Integrity Support Message (ISM).....	71
3.5.4.7.1 ISM Parameter Content.....	71
3.5.4.7.1.1 GNSS Constellation ID.....	72
3.5.4.7.1.2 ISM Effectivity Time Stamp Week Number	72
3.5.4.7.1.3 ISM Effectivity Time Stamp Time of Week.....	72
3.5.4.7.1.4 Correlation Time Constant.....	73
3.5.4.7.1.5 Additive Term for Nominal Pseudorange Error Bias	74
3.5.4.7.1.6 Scalar Term for Nominal Pseudorange Error Bias	75
3.5.4.7.1.7 Satellite Fault Probability	76
3.5.4.7.1.8 Constellation Fault Probability	77
3.5.4.7.1.9 Mean Fault Duration	78
3.5.4.7.1.10 Service Level	78
3.5.4.7.1.11 Satellite Mask.....	79
3.5.4.7.1.12 Integrity Support Message Cyclic Redundancy Check	81
3.5.5 Timing Relationships.....	81
3.5.5.1 Paging and Cutovers	81
3.5.5.2 CEI Data Sets	81
3.5.5.3 Reference Times	82
6 NOTES.....	83
6.1 Acronyms	83
6.2 Definitions.....	85
6.2.1 User Range Accuracy	85
6.2.1.1 User Differential Range Accuracy.....	86
6.2.2 GPS Week Number.....	86
6.2.3 Legendre Sequence	86
6.2.4 LDPC Submatrices.....	86
6.2.5 Reserved Data	113
6.2.6 Valid Range	113
6.2.7 Invalid Range.....	113
6.2.8 Clock, Ephemeris, Integrity (CEI) Data Set.	113

6.2.8.1 Core CEI Data Set.....	114
6.2.9 CEI Data Sequence Propagation.....	115
6.3 Supporting Material	115
6.3.1 Additional PRN Sequences.....	115
6.3.1.1 Additional L1C Ranging Code Sequences	115
6.3.1.2 Additional L1C Overlay Code Sequences	122
6.3.2 Pre-Operational Use.....	129
6.3.3 Integrated Phase Noise Characteristics.....	130
6.4 Operational Protocols.....	130
6.4.1 Lower PRN Numbers Versus Upper PRN Numbers	130
6.4.2 PRN Number Consistency	130
6.4.3 PRNs 33 and 37	130
6.4.4 PRNs 33 through 63.....	131
6.4.5 User Protocol for Signal Availability and Health Information.....	131
6.4.5.1 Alarm Indications.....	131
6.4.5.1.1 Specific Alarm Indications	131
6.4.5.2 "Marginal" Indications.....	131

LIST OF TABLES

Table 3.2-1.	Received Minimum RF Signal Strength	7
Table 3.2-2.	L1C Ranging Codes Parameter Assignments (sheet 1 of 3).....	10
Table 3.2-2	L1C Ranging Codes Parameter Assignments (sheet 2 of 3).....	11
Table 3.2-2	L1C Ranging Codes Parameter Assignments (sheet 3 of 3).....	12
Table 3.2-3.	L1C _O Overlay Code Parameter Assignments (sheet 1 of 3)	13
Table 3.2-3	L1C _O Overlay Code Parameter Assignments (sheet 2 of 3)	14
Table 3.2-3	L1C _O Overlay Code Parameter Assignments (sheet 3 of 3)	15
Table 3.5-1.	Subframe 2 Parameters (1 of 3)	40
Table 3.5-1.	Subframe 2 Parameters (2 of 3)	41
Table 3.5-1.	Subframe 2 Parameters (3 of 3)	42
Table 3.5-2.	Broadcast Navigation User Equations (sheet 1 of 4)	47
Table 3.5-2.	Broadcast Navigation User Equations (sheet 2 of 4)	48
Table 3.5-2.	Broadcast Navigation User Equations (sheet 3 of 4)	49
Table 3.5-2.	Broadcast Navigation User Equations (sheet 4 of 4)	50
Table 3.5-3.	UTC Parameters.....	59
Table 3.5-4.	GPS/GNSS Time Offset Parameters.....	61
Table 3.5-5.	Earth Orientation Parameters	62
Table 3.5-6.	Reduced Almanac Parameters*****	65
Table 3.5-7.	Midi Almanac Parameters.....	66
Table 3.5-8.	Differential Correction Parameters	69
Table 3.5-9	ISM Parameters	71
Table 3.5-10	Service Level	79
Table 3.5-11	PRN Mapping.....	80
Table 6.2-1.	Legendre Sequence (Octal).....	87
Table 6.2-2.	LDPC Submatrix A for Subframe 2 * (sheet 1 of 11)	88
Table 6.2-2	LDPC Submatrix A for Subframe 2 * (sheet 2 of 11)	89
Table 6.2-2	LDPC Submatrix A for Subframe 2 * (sheet 3 of 11)	90
Table 6.2-2	LDPC Submatrix A for Subframe 2 * (sheet 4 of 11)	91
Table 6.2-2	LDPC Submatrix A for Subframe 2 * (sheet 5 of 11)	92
Table 6.2-2	LDPC Submatrix A for Subframe 2 * (sheet 6 of 11)	93

Table 6.2-2	LDPC Submatrix A for Subframe 2 * (sheet 7 of 11)	94
Table 6.2-2	LDPC Submatrix A for Subframe 2 * (sheet 8 of 11)	95
Table 6.2-2	LDPC Submatrix A for Subframe 2 * (sheet 9 of 11)	96
Table 6.2-2	LDPC Submatrix A for Subframe 2 * (sheet 10 of 11)	97
Table 6.2-2	LDPC Submatrix A for Subframe 2 * (sheet 11 of 11)	98
Table 6.2-3.	LDPC Submatrix B for Subframe 2 *	98
Table 6.2-4.	LDPC Submatrix C for Subframe 2 *	98
Table 6.2-5.	LDPC Submatrix D for Subframe 2 *	98
Table 6.2-6.	LDPC Submatrix E for Subframe 2 *	99
Table 6.2-7.	LDPC Submatrix T for Subframe 2 * (sheet 1 of 4).....	99
Table 6.2-7.	LDPC Submatrix T for Subframe 2 * (sheet 2 of 4).....	101
Table 6.2-7.	LDPC Submatrix T for Subframe 2 * (sheet 3 of 4).....	102
Table 6.2-7.	LDPC Submatrix T for Subframe 2 * (sheet 4 of 4).....	103
Table 6.2-8.	LDPC Submatrix A for Subframe 3 * (sheet 1 of 5)	104
Table 6.2-8.	LDPC Submatrix A for Subframe 3 * (sheet 2 of 5)	105
Table 6.2-8.	LDPC Submatrix A for Subframe 3 * (sheet 3 of 5)	106
Table 6.2-8.	LDPC Submatrix A for Subframe 3 * (sheet 4 of 5)	107
Table 6.2-8.	LDPC Submatrix A for Subframe 3 * (sheet 5 of 5)	108
Table 6.2-9.	LDPC Submatrix B for Subframe 3 *	108
Table 6.2-10.	LDPC Submatrix C for Subframe 3 *	108
Table 6.2-11.	LDPC Submatrix D for Subframe 3 *	108
Table 6.2-12.	LDPC Submatrix E for Subframe 3 *	108
Table 6.2-13.	LDPC Submatrix T for Subframe 3 * (sheet 1 of 2).....	109
Table 6.2-13.	LDPC Submatrix T for Subframe 3 * (sheet 2 of 2).....	110
Table 6.2-14.	Number of 1's in LDPC Submatrix A for Subframe 2	111
Table 6.2-15.	Number of 1's in LDPC Submatrix T for Subframe 2.....	111
Table 6.2-16.	Number of 1's in LDPC Submatrix A for Subframe 3	112
Table 6.2-17.	Number of 1's in LDPC Submatrix T for Subframe 3.....	113
Table 6.2-18.	CEI Data Set Parameters	114
Table 6.3-1.	Additional L1C Ranging Codes Parameter Assignments (sheet 1 of 7).....	116
Table 6.3-1.	Additional L1C Ranging Codes Parameter Assignments (sheet 2 of 7).....	117

Table 6.3-1.	Additional L1C Ranging Codes Parameter Assignments (sheet 3 of 7).....	118
Table 6.3-1.	Additional L1C Ranging Codes Parameter Assignments (sheet 4 of 7).....	119
Table 6.3-1.	Additional L1C Ranging Codes Parameter Assignments (sheet 5 of 7).....	120
Table 6.3-1.	Additional L1C Ranging Codes Parameter Assignments (sheet 6 of 7).....	121
Table 6.3-1.	Additional L1C Ranging Codes Parameter Assignments (sheet 7 of 7).....	122
Table 6.3-2.	Additional L1C _O Overlay Code Parameter Assignments (sheet 1 of 7).....	123
Table 6.3-2.	Additional L1C _O Overlay Code Parameter Assignments (sheet 2 of 7).....	124
Table 6.3-2.	Additional L1C _O Overlay Code Parameter Assignments (sheet 3 of 7).....	125
Table 6.3-2.	Additional L1C _O Overlay Code Parameter Assignments (Sheet 4 of 7)	126
Table 6.3-2.	Additional L1C _O Overlay Code Parameter Assignments (Sheet 5 of 7)	127
Table 6.3-2.	Additional L1C _O Overlay Code Parameter Assignments (Sheet 6 of 7)	128
Table 6.3-2.	Additional L1C _O Overlay Code Parameter Assignments (Sheet 7 of 7)	129

LIST OF FIGURES

Figure 3.2-1.	Generation of L1C _P -/L1C _D -Codes	16
Figure 3.2-2.	L1C _O -Code Generator Configuration	17
Figure 3.2-3.	L1C Message Structure.....	19
Figure 3.2-4.	BCH (51, 8) Code Generator	20
Figure 3.2-5.	Parity Check Matrix H for LDPC Code.....	22
Figure 3.2-6.	Conceptual Block Interleaver	24
Figure 3.3-1.	L1C _P -/L1C _D -/L1C _O -Code Timing Relationships.....	26
Figure 3.3-2.	Subcarrier Polarity Mapping.....	27
Figure 3.5-2.	Subframe 3, Page 1 - UTC & IONO.....	31
Figure 3.5-3	Subframe 3, Page 2	32
Figure 3.5-4.	Subframe 3, Page 3 - Reduced Almanac	33
Figure 3.5-5.	Subframe 3, Page 4 - Midi Almanac.....	34
Figure 3.5-6.	Subframe 3, Page 5 - Differential Correction	35
Figure 3.5-7.	Subframe 3, Page 6 - Text.....	36
Figure 3.5-8.	Subframe 3, Page 7 - SV Configuration	37
Figure 3.5-8a	Subframe 3, Page 8, Integrity Support Message	38
Figure 3.5-9.	Reduced Almanac Packet Content.....	65
Figure 3.5-10.	Differential Correction Data Packet.....	68
Figure 3.5-11.	Subframe 3, Page 7 - SV Configuration.....	70
Figure 6-1	Typical GPS III and GPS IIIF L1C Carrier Phase Noise Spectral Density	130

1 INTRODUCTION

1.1 Scope

This Interface Specification (IS) defines the characteristics of a signal transmitted from Global Positioning System (GPS) satellites to navigation receivers on radio frequency (RF) link 1 (L1). While there are multiple signals broadcast within the frequency band of L1, this IS defines only the signal denoted L1 Civil (L1C). Throughout this document, the L1 carrier denotes 1575.42 MHz.

1.2 Interface Definition

Utilizing the L1 open link defined in this document, GPS space vehicles (SVs), except Block II/IIA, IIR/IIR-M, and IIF SVs, shall transmit continuous earth coverage L1C signal that provides the ranging codes and the system data needed to accomplish the navigation mission to all users having RF visibility to SVs and suitable receivers.

1.3 IS Approval and Changes

The GPS Directorate (SMC/GP) is the necessary authority to make this IS effective. SMC/GP administers approvals under the auspices of the Configuration Control Board (CCB), which is governed by the appropriate SMC/GP Operating Instruction. The SMC/GP CCB membership includes the United States Department of Transportation representative for civil organizations and public interest.

The Interface Control Contractor (ICC), designated by the government, is responsible for the basic preparation, obtaining approval, distribution, retention, and Interface Control Working Group (ICWG) coordination of this IS in accordance with GP-03-001A.

A proposal to change the approved version of this IS can be submitted by any ICWG participating organization to the GPS Directorate and/or the ICC. The ICC is responsible for the preparation of the change paper and change coordination in the form of a Proposed Interface Revision Notice (PIRN) and is responsible for coordination of PIRNs with the ICWG. The ICWG coordinated PIRN must be submitted as an Interface Revision Notice (IRN) to the GPS Directorate CCB for review and approval.

2 APPLICABLE DOCUMENTS

2.1 Applicable Documents

The following documents of the issue specified contribute to the definition of the interfaces between the GPS Space Segment (SS) and the User Segment (US), and form a part of this IS to the extent specified herein.

Specifications

None

Standards

None

Other Publications

IS-GPS-200 (current issue)

Navstar GPS Space Segment/Navigation User
Interfaces

GP-03-001A (Current Issue)

GPS Adjudication Working Group (AWG) and Rough
Order of Magnitude (ROM)/ Impact Assessment (IA)
Charter

2.2 Reference Documents

The following documents are for reference only and are not controlled by the GPS Directorate:

[1] T. Richardson, R. Urbanke, "Efficient Encoding of Low-Density Parity-Check Codes," IEEE Transactions on Information Theory, Vol. 47, NO. 2, February 2001.

[2] J. Betz, "Binary Offset Carrier Modulations for Radionavigation," Journal of the Institute of Navigation, vol. 48, pp. 227-246, 2001

IERS Technical Note 36

International Earth Rotation and Reference System Technical Note 36

3 SIGNAL REQUIREMENTS

The requirements specified in this section define the requisite characteristics of the SS/US interface for the GPS L1C signal.

3.1 Signal Structure

The GPS SV typically transmits multiple distinct signals modulated on the L1 RF carrier. The signals include C/A, P(Y), M, and L1C which are modulated on the carrier frequency.

The L1C signal defined in this IS consists of two main components; one denoted $L1C_P$ to represent a pilot signal, without any data message, that is spread by a ranging code, and $L1C_D$ that is spread by a ranging code and modulated by a data message. The $L1C_P$ is also modulated by an SV unique overlay code, $L1C_O$.

The $L1C_P$ and $L1C_D$ components are transmitted using ranging codes defined in Section 3.2.2.

The SVs shall transmit intentionally "incorrect" versions of the respective ranging codes as needed to protect users from receiving and utilizing anomalous signals. These "incorrect" codes are termed non-standard $L1C_P$ (NSCP) and non-standard $L1C_D$ (NSCD).

Non-standard codes are not for utilization by the users and, therefore, are not defined in this document.

The data message on $L1C_D$, denoted $D_{L1C}(t)$, includes SV ephemerides, system time, system time offsets, SV clock behavior, status messages, and other data messages. The message structure and data encoding techniques are defined in Section 3.2.3.

The $L1C_D$ signal is modulated on the L1 RF carrier using a Binary Offset Carrier (BOC) (1, 1) modulation technique. The $L1C_P$ signal is modulated on the L1 RF carrier using a Time-Multiplexed BOC (TMBOC) modulation technique. The TMBOC technique utilized by $L1C_P$ signal uses a combination of BOC (1, 1) and BOC (6, 1) modulation as described in Section 3.3.

3.2 Signal Definition

3.2.1 Signal Characteristics

The following specifies the characteristics and quality of the L1C signal.

3.2.1.1 Frequency Plan

The carrier frequency for the L1C signal shall be coherently derived from a frequency source common with other signals within the SV.

The nominal frequency of this source as it appears to an observer on the ground is 10.23 MHz. The SV carrier frequency and clock rates, as they would appear to an observer located in the SV, are offset to compensate for relativistic effects. The clock rates are offset by $\Delta f/f = -4.4647E-10$, which is equivalent to a change in the L1C-code chipping rate of 1.023 MHz by a $\Delta f = -4.5674E-4$ Hz. This results in an offset L1C-code chipping rate of 1.02299999954326 MHz. The nominal carrier frequency (f_0) - as it appears to an observer on the ground - shall be 1575.42 MHz.

The requirements specified in this IS shall pertain to the signal contained within a 30.69 MHz bandwidth centered about the L1 nominal frequency.

The L1C signal shall utilize a modulation technique of BOC ($f_s, 1$) which specifies a subcarrier frequency of $f_s \times 1.023$ MHz and a spreading code chipping rate of 1×1.023 MHz = 1.023 MHz.

3.2.1.2 Signal Polarization

The transmitted signal shall be Right-Hand Circularly Polarized (RHCP).

For an angular range of ± 13.8 degrees from nadir, the L1 ellipticity shall be no worse than 1.8 dB.

3.2.1.3 Carrier Phase Noise

The phase noise spectral density of the unmodulated carrier shall be such that an approximation to the third order Jaffe-Rechtin phase lock loop, closed-loop transfer function $H(f)$ such that $|1 - H(f)|^2 = f^6/(f_n^6 + f^6)$ where $f_n = 3B_L/(5\pi)$, which has a 10 Hz one-sided loop noise bandwidth, shall be able to track the carrier to an accuracy of 0.035 radians rms.

3.2.1.4 Spurious Transmissions

In-band spurious transmissions, from the SV, shall be at or below -40 dBc over the band specified in 3.2.1.1. In-band spurious transmissions are defined as transmissions within the band specified in 3.2.1.1 which are not expressly components of the L1 signal.

3.2.1.5 Correlation Loss

Correlation loss is defined as the difference between the SV power received in the bandwidth defined in 3.2.1.1 and the signal power recovered in an ideal correlation receiver of the same bandwidth using an exact replica of the waveform within an ideal sharp-cutoff filter bandwidth centered at L1, whose bandwidth corresponds to that specified in 3.2.1.1 and whose phase is linear over that bandwidth. The correlation loss apportionment due to SV modulation and filtering imperfections shall be 0.2 dB maximum.

3.2.1.6 Signal Component Phasing

3.2.1.6.1 Phase Relationship

Carriers of the two L1C components defined in Section 3.1 shall be in the same phase within ± 100 milliradians. Carriers of the two L1C components shall be in the same phase (within ± 100 milliradians) as the P(Y)-code carrier. See IS-GPS-200 for phase relationships to other L1 signals.

3.2.1.6.2 Phase Continuity

While a satellite is broadcasting standard L1C_P code and standard L1C_D code signals with data which indicates L1C signal health is OK, there will not be any commanded operation causing an intentional phase discontinuity. This does not apply to phase discontinuities caused by signal modulation. Phase discontinuities are subject to the requirements of 3.2.1.6.1.

3.2.1.7 Signal Characteristics

3.2.1.7.1 Signal Coherence

All transmitted signals for a particular SV shall be coherently derived from the same on-board frequency standard.

On the L1 carrier, the chip transitions of the two modulating signals, L1C_D and L1C_P, shall be such that the average time difference between them (i.e. L1C_D/L1C_P), and between each and the transitions of L1P(Y) (i.e. L1C_D/L1P(Y), L1C_P/L1P(Y)), do not exceed 10 nanoseconds.

The variable time difference shall not exceed 1 nanosecond (95% probability), when including consideration of the temperature and antenna effect changes during a vehicle orbital revolution. Corrections for the bias components of the time difference are provided to the US in the CNAV-2 message using parameters designated as ISCs (reference paragraph 3.5.3.9.1).

3.2.1.7.2 Signal Distortion

The duration of the “+1 polarity” portions of the BOC (1, 1) code shall equal the duration of the “-1 polarity” portions of the BOC (1, 1) code within 5 nanoseconds as measured at the zero crossing point.

The duration of the “+1 polarity” portions of the BOC (6, 1) code shall equal the duration of the “-1 polarity” portions of the BOC (6, 1) code within 5 nanoseconds as measured at the zero crossing point.

3.2.1.8 Equipment Group Delay

Equipment group delay is defined as the delay between the signal radiated output of a specific SV (measured at the antenna phase center as observed from the signal's zero crossings) and the output of that SV's on-board frequency source; the delay consists of a bias term and an uncertainty. The bias term is of no concern to the US since it is included in the clock correction parameters relayed in the navigation data, and is therefore accounted for by the user computations of system time. The uncertainty (variation) of this delay, as well as the group delay differential, between the reference signal and the signals of L1C, are defined in the following subsections.

3.2.1.8.1 Group Delay Uncertainty

The effective uncertainty of the group delay shall not exceed 1.5 nanoseconds (95% probability).

3.2.1.8.2 Group Delay Differential

Not applicable. See Sections 3.2.1.7.1 (Signal Coherence) and 3.5.3.9.1 (Inter-Signal Group Delay Differential Correction).

3.2.1.8.3 Space Service Volume (SSV) Group Delay Differential

The group delay differential for the radiated L1 signal with respect to the Earth Coverage signal for users of the Space Service Volume are provided in <http://www.igs.org/products/ssv>

3.2.1.9 Signal Power Levels

The SV shall provide an L1C signal strength at End-of-Life (EOL), worst-case, in order to meet the minimum effective received signal levels specified in Table 3.2-1. Any combining operation done by the SV and associated loss is compensated by an increase in SV transmitted power and thus transparent to the user segment. For terrestrial users, the minimum effective received signal power is measured at the output of a 3 dBi linearly polarized user receiving antenna (located near ground) at worst normal orientation, when the SV elevation angle is higher than 5 degrees and assuming 0.5 dB atmospheric loss. For orbital users, the minimum effective received signal power is measured at the output of a 0 dBi ideal right-hand circularly polarized (i.e. 0 dB axial ratio) user receiving antenna (in geosynchronous orbit) at 23.5 degrees off nadir and using 0 dB atmospheric loss. The received signal levels are observed within the in-band allocation defined in Para. 3.2.1.1

The SV shall provide signals with the following characteristic:

the off-axis relative power (referenced to peak transmitted power) shall not decrease by more than 2 dB from the Edge-of-Earth (EOE) to nadir,

nor more than 10 dB from EOE to 20 degrees off nadir,

and no more than 19.5 dB from EOE to 23.5 degrees off nadir;

the power drop off between EOE and ± 23.5 degrees off nadir shall be in a monotonically decreasing fashion.

Higher received signal levels than those shown in Table 3.2-1 can be caused by such factors as SV temperature-induced transmitter power variations, voltage variations and power amplifier variations, and due to variability in link atmospheric path loss. The terrestrial user's maximum received signal power level resulting from these factors is not expected to exceed -154 dBW total for the composite L1C signal. For purposes of establishing user receiver dynamic range for receiver design and test, the maximum received signal power level is not expected to exceed -150 dBW total for the composite L1C signal.

Table 3.2-1. Received Minimum RF Signal Strength

	Terrestrial	Orbital		Terrestrial	Orbital
L1C	- 157 dBW	- 182.5 dBW*	L1C _P	- 158.25 dBW	- 183.75 dBW*
			L1C _D	- 163 dBW	- 188.5 dBW*
*Over 99.5% of the solid angle inside a cone with a 23.5 degree half-angle with its apex at the SV and measured from 0 degrees at the center of the Earth.					

3.2.2 PRN Code Characteristics

The characteristics of the L1C_P-, L1C_D-, and the L1C_O-codes are defined below in terms of their structure and the basic method used for generating them. Figures 3.2-1 and 3.2-2 depict simplified block diagrams of the scheme for generating the L1C PRN codes.

3.2.2.1 L1C Codes

The PRN ranging codes L1C_{Pi}(t) and L1C_{Di}(t) for PRN signal number i are independent, time synchronized, and 10 milliseconds in length at a chipping rate of 1.023 Mbps, for total length of 10230 chips. In addition, there is an overlay modulation code L1C_{Oi}(t) for PRN signal number i which also is independent, time synchronized, and 18 seconds in length at a rate of 100 bps, for total length of 1800 bits. The overlay code, L1C_{Oi}(t), is modulo-2 added to L1C_{Pi}(t). (See Figure 3.3-2 for timing relationship.)

Assignment of these code segments by PRN signal number is given in Table 3.2-2 and Table 3.2-3. The tables provide code segments for 63 PRN numbers that are designated for GPS use.

3.2.2.1.1 Ranging Code Structure

Both $L1C_{Pi}(t)$ and $L1C_{Di}(t)$ are constructed using the same method. Each ranging code is derived from a unique length-10223 sequence with a common 7-bit expansion sequence inserted at a PRN signal number-dependent point.

The unique length-10223 sequence for each ranging code is derived from a single fixed length-10223 sequence called a Legendre sequence $L(t)$, for $t = 0, \dots, 10222$. $L(t)$ is defined as,

$$L(0) = 0 ;$$

$$L(t) = 1, \quad \text{if there exists an integer } x \text{ such that } t \text{ is congruent to } x^2 \text{ modulo } 10223;$$

$$L(t) = 0, \quad \text{if there exists no integer } x \text{ such that } t \text{ is congruent to } x^2 \text{ modulo } 10223.$$

Table 6.2-1 in Section 6.2.3 provides the generated sequence of the above defined $L(t)$.

The above Legendre sequence is used to construct the unique length-10223 sequence used for each ranging code. This sequence, called a Weil-code, is the exclusive-or of $L(t)$ and a shift of $L(t)$. A Weil-code $W_i(t ; w)$ is specified by Weil Index w , ranging from 1 to 5111, which represents the shift of $L(t)$ and is defined as,

$$W_i(t ; w) = L(t) \oplus L((t + w) \text{ modulo } 10223) \quad \text{for } t = 0 \text{ to } 10222.$$

Assignment of Weil Index, w , by PRN signal number, i , is given in Table 3.2-2.

Finally, the ranging code is constructed by inserting a fixed expansion sequence into the Weil-code. The expansion sequence is composed of seven bit values 0 1 1 0 1 0 0. The insert point is specified by Insertion Index p , where $p = 1$ to 10223. The expansion sequence is inserted before the p^{th} value of the Weil-code.

Thus the ranging code $L1C_{Pi}(t)/L1C_{Di}(t)$ is defined as,

$$\begin{aligned} L1C_{Pi}(t)/L1C_{Di}(t) &= W_i(t ; w), & \text{for } t = 0, 1, \dots, p - 2; \\ L1C_{Pi}(t)/L1C_{Di}(t) &= 0, & \text{for } t = p - 1; \\ L1C_{Pi}(t)/L1C_{Di}(t) &= 1, & \text{for } t = p; \\ L1C_{Pi}(t)/L1C_{Di}(t) &= 1, & \text{for } t = p + 1; \\ L1C_{Pi}(t)/L1C_{Di}(t) &= 0, & \text{for } t = p + 2; \\ L1C_{Pi}(t)/L1C_{Di}(t) &= 1, & \text{for } t = p + 3; \\ L1C_{Pi}(t)/L1C_{Di}(t) &= 0, & \text{for } t = p + 4; \\ L1C_{Pi}(t)/L1C_{Di}(t) &= 0, & \text{for } t = p + 5; \\ L1C_{Pi}(t)/L1C_{Di}(t) &= W_i(t - 7 ; w), & \text{for } t = p + 6, p + 7, \dots, 10229. \end{aligned}$$

Assignment of Insertion Index, p , by PRN signal number, i , is given in Table 3.2-2. The generation of L1C_P-code and L1C_D-code is conceptually described in Figure 3.2-1.

3.2.2.1.2 Overlay Code Structure

The overlay codes L1C_{O_i}(t) are constructed using Linear Feedback Shift Register (LFSR) methods. These codes are 2047 bits long truncated to 1800-bit long sequences and are constructed using 11-stage LFSR generators as described below. This section provides the code generation method for the first 63 PRN numbers and Section 6.3.1.2 provides the generation method for the additional PRN signal numbers 64 through 210.

The overlay codes are derived from the addition (exclusive-or) of two sequences.

The two sequences, denoted as S1 and S2, are each derived from a PRN signal number-dependent code generator polynomial represented by $P_i(x)$. The generator polynomial for S1 is defined as,

$$P_i(x) = \sum_{j=0}^{11} m_{i,j} x^j,$$

where the coefficient $m_{i,j}$ is defined for each PRN signal number, i . For PRN signal numbers 1 - 63, only the sequence S1 is used and, as such, S2 is not needed. The sequence S2 is added to S1 sequence to generate the additional PRN signal numbers 64 through 210 as further described in Section 6.3.1.2.

The generator polynomial coefficient $m_{i,j}$ for PRN signal numbers 1 - 63 are specified in Table 3.2-3. Table 3.2-3 also specifies the initial 11 bits of the sequence, which is also the initial condition of the code generator for each PRN signal number. The final 11 bits of the sequence are also shown in Table 3.2-3; these are the last 11 values after the code generator is clocked for 1800 bits. The L1C_O-code generator is conceptually described in Figure 3.2-2.

Table 3.2-2. L1C Ranging Codes Parameter Assignments (sheet 1 of 3)

GPS PRN Signal No.	L1C _P				L1C _D			
	Weil Index (<i>w</i>)	Insertion Index (<i>p</i>)	Initial 24 Chips (Octal)	Final 24 Chips (Octal)	Weil Index (<i>w</i>)	Insertion Index (<i>p</i>)	Initial 24 Chips (Octal)	Final 24 Chips (Octal)
1	5111	412	05752067	20173742	5097	181	77001425	52231646
2	5109	161	70146401	35437154	5110	359	23342754	46703351
3	5108	1	32066222	00161056	5079	72	30523404	00145161
4	5106	303	72125121	71435437	4403	1110	03777635	11261273
5	5103	207	42323273	15035661	4121	1480	10505640	71364603
6	5101	4971	01650642	32606570	5043	5034	42134174	55012662
7	5100	4496	21303446	03475644	5042	4622	00471711	30373701
8	5098	5	35504263	11316575	5104	1	32237045	07706523
9	5095	4557	66434311	23047575	4940	4547	16004766	71741157
10	5094	485	52631623	07355246	5035	826	66234727	42347523
11	5093	253	04733076	15210113	4372	6284	03755314	12746122
12	5091	4676	50352603	72643606	5064	4195	20604227	34634113
13	5090	1	32026612	63457333	5084	368	25477233	47555063
14	5081	66	07476042	46623624	5048	1	32025443	01221116
15	5080	4485	22210746	35467322	4950	4796	35503400	37125437
16	5069	282	30706376	70116567	5019	523	70504407	32203664
17	5068	193	75764610	62731643	5076	151	26163421	62162634
18	5054	5211	73202225	14040613	3736	713	52176727	35012616
19	5044	729	47227426	07750525	4993	9850	72557314	00437232
20	5027	4848	16064126	37171211	5060	5734	62043206	32130365
21	5026	982	66415734	01302134	5061	34	07151343	51515733
NOTES:								

Table 3.2-2 L1C Ranging Codes Parameter Assignments (sheet 2 of 3)

GPS PRN Signal No.	L1C _P				L1C _D			
	Weil Index (<i>w</i>)	Insertion Index (<i>p</i>)	Initial 24 Chips (Octal)	Final 24 Chips (Octal)	Weil Index (<i>w</i>)	Insertion Index (<i>p</i>)	Initial 24 Chips (Octal)	Final 24 Chips (Octal)
22	5014	5955	27600270	37672235	5096	6142	16027175	73662313
23	5004	9805	66101627	32201230	4983	190	26267340	55416712
24	4980	670	17717055	37437553	4783	644	36272365	22550142
25	4915	464	47500232	23310544	4991	467	67707677	31506062
26	4909	29	52057615	07152415	4815	5384	07760374	44603344
27	4893	429	76153566	02571041	4443	801	73633310	05252052
28	4885	394	22444670	52270664	4769	594	30401257	70603616
29	4832	616	62330044	61317104	4879	4450	72606251	51643216
30	4824	9457	13674337	43137330	4894	9437	37370402	30417163
31	4591	4429	60635146	20336467	4985	4307	74255661	20074570
32	3706	4771	73527653	40745656	5056	5906	10171147	26204176
33	5092	365	63772350	50272475	4921	378	12242515	07105451
34	4986	9705	33564215	75604301	5036	9448	17426100	31062227
35	4965	9489	52236055	52550266	4812	9432	75647756	36516016
36	4920	4193	64506521	15334214	4838	5849	71265340	07641474
37	4917	9947	73561133	53445703	4855	5547	74355073	35065520
3	4858	824	12647121	71136024	4904	9546	45253014	03155010
39	4847	864	16640265	01607455	4753	9132	12452274	34041736
40	4790	347	11161337	73467421	4483	403	07011213	20162561
41	4770	677	22055260	54372454	4942	3766	35143750	01603755
42	4318	6544	11546064	11526534	4813	3	26442600	40541055
NOTES:								

Table 3.2-2 L1C Ranging Codes Parameter Assignments (sheet 3 of 3)

GPS PRN Signal No.	L1C _P				L1C _D			
	Weil Index (<i>w</i>)	Insertion Index (<i>p</i>)	Initial 24 Chips (Octal)	Final 24 Chips (Octal)	Weil Index (<i>w</i>)	Insertion Index (<i>p</i>)	Initial 24 Chips (Octal)	Final 24 Chips (Octal)
43	4126	6312	24765004	16522173	4957	684	67214123	64750626
44	3961	9804	14042504	74053703	4618	9711	62274362	72550016
45	3790	278	53512265	52211303	4669	333	23371051	36130364
46	4911	9461	15317006	72655147	4969	6124	25121057	25236175
47	4881	444	16151224	01212152	5031	10216	20362622	43732204
48	4827	4839	67454561	10410122	5038	4251	33050463	02316015
49	4795	4144	47542743	22473073	4740	9893	65334051	00212370
50	4789	9875	65057230	63145220	4073	9884	65523456	35163655
51	4725	197	77415771	65734110	4843	4627	53741004	33771603
52	4675	1156	75364651	25167435	4979	4449	66360341	41161255
53	4539	4674	75664330	17524136	4867	9798	34421651	76257261
54	4535	10035	44600202	47064764	4964	985	04530741	33512503
55	4458	4504	23211425	14016156	5025	4272	12621031	16237466
56	4197	5	51504740	11723025	4579	126	62330452	24120336
57	4096	9937	47712554	76760325	4390	10024	67510404	11103121
58	3484	430	67325233	04724615	4763	434	00726605	36467526
59	3481	5	61517015	72504743	4612	1029	00200154	66444010
60	3393	355	43217554	51215201	4784	561	37533004	70455364
61	3175	909	52520062	00630473	3716	289	73771510	26726105
62	2360	1622	77073716	71217605	4703	638	44071707	63663333
63	1852	6284	56350460	50200707	4851	4353	34665654	42142704
NOTES:								

Table 3.2-3. L1Co Overlay Code Parameter Assignments (sheet 1 of 3)

GPS PRN Signal No.	S1 Polynomial Coefficient (Octal) * (m_{ij})	Initial 11 Bits (Octal †) **	Final 11 Bits (Octal †)
1	5111	3266	0410
2	5421	2040	3153
3	5501	1527	1767
4	5403	3307	2134
5	6417	3756	3510
6	6141	3026	2260
7	6351	0562	2433
8	6501	0420	3520
9	6205	3415	2652
10	6235	0337	2050
11	7751	0265	0070
12	6623	1230	1605
13	6733	2204	1247
14	7627	1440	0773
15	5667	2412	2377
16	5051	3516	1525
17	7665	2761	1531
18	6325	3750	3540
19	4365	2701	0524
20	4745	1206	1035
21	7633	1544	3337

NOTES:

* The polynomial coefficient is given as $1, m_{10}, \dots, m_1, 1$. Thus octal 5111 corresponds to the generator polynomial $P_1(x) = 1 + x^3 + x^6 + x^9 + x^{11}$.

** The initial 11 bits also represent the initial condition, n_{11}, \dots, n_1 , for each PRN signal number. (See Figure 3.2-2)

† The initial and the final bit values are obtained after dropping the initial bit value 0. For example octal 3266 corresponds to binary 1 1 0 1 0 1 1 0 1 1 0.

Table 3.2-3 L1Co Overlay Code Parameter Assignments (sheet 2 of 3)

GPS PRN Signal No.	S1 Polynomial Coefficient (Octal) * (m _{ij})	Initial 11 Bits (Octal †) **	Final 11 Bits (Octal †)
22	6747	1774	0176
23	4475	0546	0244
24	4225	2213	1027
25	7063	3707	1753
26	4423	2051	3502
27	6651	3650	0064
28	4161	1777	2275
29	7237	3203	0044
30	4473	1762	2777
31	5477	2100	0367
32	6163	0571	0535
33	7223	3710	3776
34	6323	3535	2677
35	7125	3110	0102
36	7035	1426	2520
37	4341	0255	2444
38***	4353	0321	3770
39***	4107	3124	1517
40***	5735	0572	1133
41***	6741	1736	3754
42***	7071	3306	0033

NOTES:

* The polynomial coefficient is given as 1, m₁₀, ..., m₁, 1. Thus octal 5111 corresponds to the generator polynomial P₁(x) = 1 + x³ + x⁶ + x⁹ + x¹¹.

** The initial 11 bits also represent the initial condition, n₁₁, ..., n₁, for each PRN signal number. (See Figure 3.2-2)

*** Note: PRNs 38-63 are required per this Table if a manufacturer chooses to include these PRNs in their receiver design.

† The initial and the final bit values are obtained after dropping the initial bit value 0.

Table 3.2-3 L1Co Overlay Code Parameter Assignments (sheet 3 of 3)

GPS PRN Signal No. ***	S1 Polynomial Coefficient (Octal) * (m_{ij})	Initial 11 Bits (Octal †) **	Final 11 Bits (Octal †)
43	4563	1307	1170
44	5755	3763	1567
45	6127	1604	3534
46	4671	1021	2515
47	4511	2624	0104
48	4533	0406	3343
49	5357	0114	1510
50	5607	0077	2170
51	6673	3477	0710
52	6153	1000	3375
53	7565	3460	2650
54	7107	2607	3307
55	6211	2057	2262
56	4321	3467	2161
57	7201	0706	2076
58	4451	2032	1200
59	5411	1464	0643
60	5141	0520	2000
61	7041	1766	3377
62	6637	3270	1605
63	4577	0341	1552

NOTES:

* The polynomial coefficient is given as $1, m_{10}, \dots, m_1, 1$. Thus octal 5111 corresponds to the generator polynomial $P_1(x) = 1 + x^3 + x^6 + x^9 + x^{11}$.

** The initial 11 bits also represent the initial condition, n_{11}, \dots, n_1 , for each PRN signal number. (See Figure 3.2-2)

*** Note: PRNs 38-63 are required per this Table if a manufacturer chooses to include these PRNs in their receiver design.

† The initial and the final bit values are obtained after dropping the initial bit value 0.

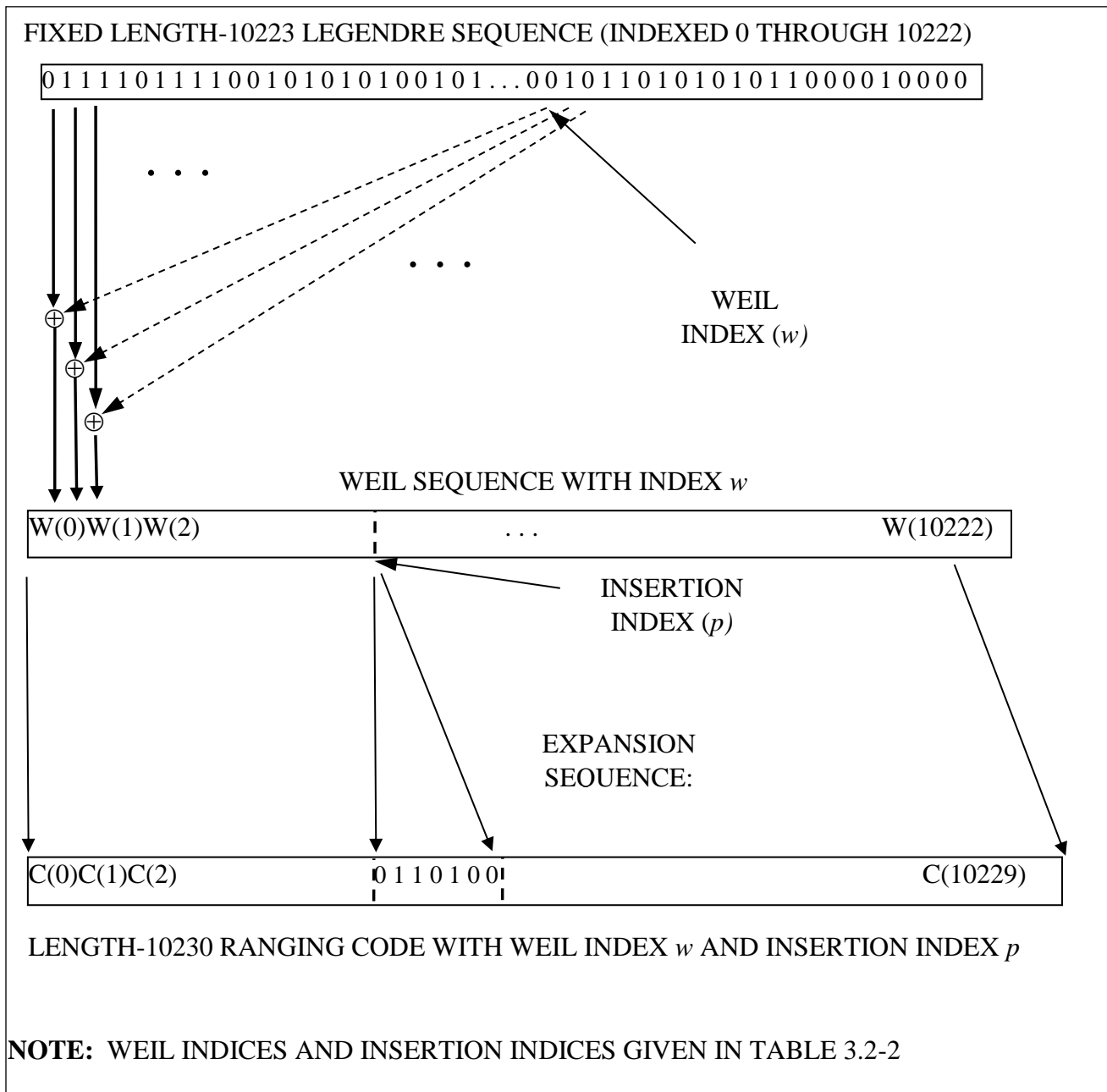

Figure 3.2-1. Generation of L1C_p-/L1C_D-Codes

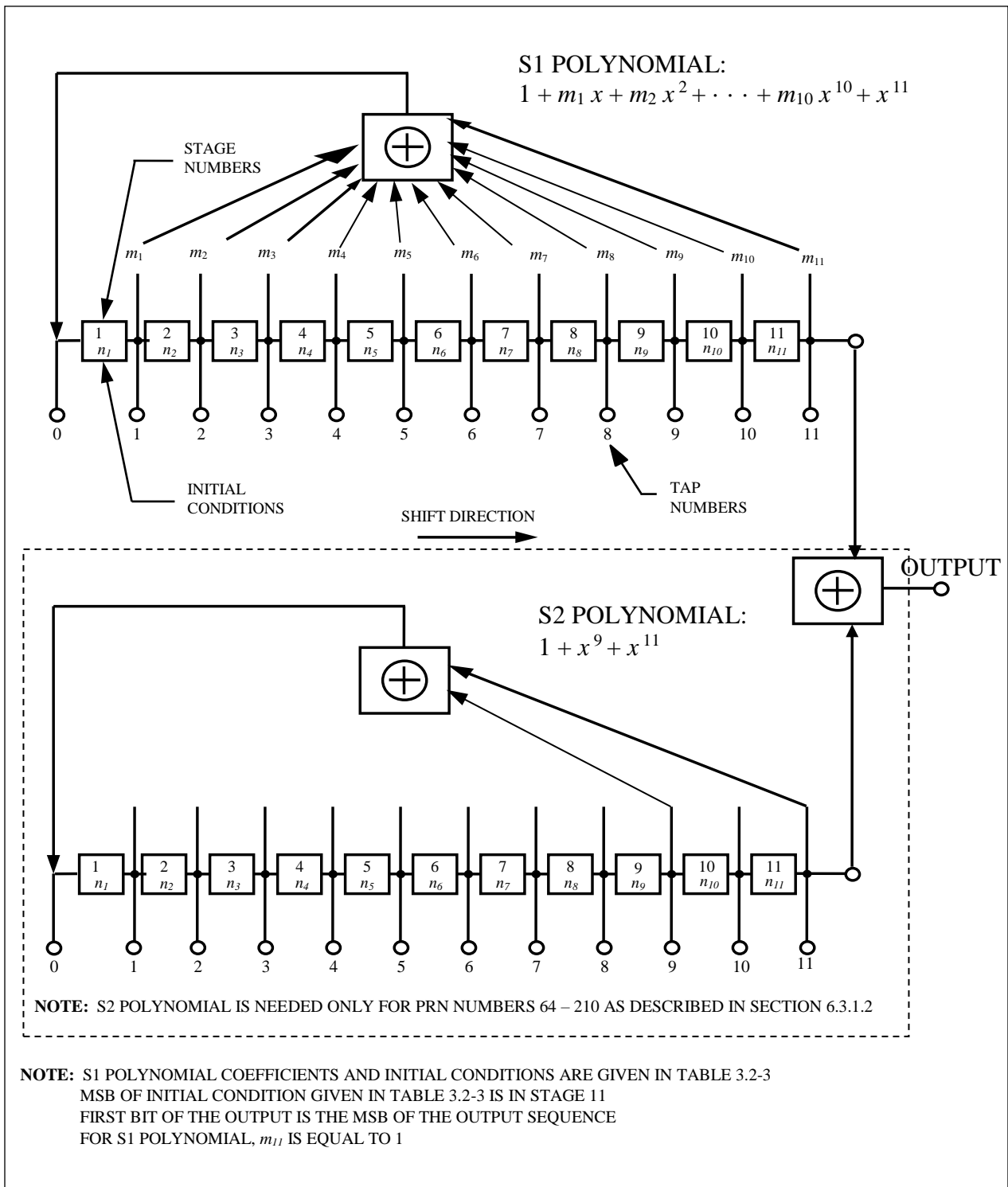

Figure 3.2-2. L1C0-Code Generator Configuration

3.2.2.2 Non-Standard Codes

The non-standard codes, used to protect the user from tracking an anomalous navigation signal, are not for utilization by the user and, therefore, are not defined in this document. In addition to the SV's capability to autonomously initiate the broadcast of non-standard codes, the SVs shall also be capable of initiating and terminating the broadcast of NSCP and/or NSCD code(s) independently of each other, in response to a Control Segment (CS) command.

3.2.3 Message Characteristics

The following defines the overall message structure of the L1C message, $D_{L1C}(t)$. The data content of the L1C message is defined in Section 3.5.

3.2.3.1 L1C Message Structure

The message modulated onto the $L1C_D$ signal consists of subframes and frames, as shown in Figure 3.2-3. A frame is divided into three subframes of varying length. Multiple frames are required to broadcast a complete data message set to users.

Each frame shall consist of 9 bits of "Time of Interval" (TOI) data in subframe 1, 600 bits of "non-variable" clock and ephemeris data with Cyclic Redundancy Check (CRC) in subframe 2, and 274 bits of "variable" data with CRC in subframe 3. The content of subframe 3 nominally varies from one frame to the next and is identified by a page number. The content of subframe 2 is nominally non-variant over a period of multiple frames.

Subframe 1 provides 9-bit TOI data that corresponds to the SV time epoch at the start (leading edge) of the next following frame (reference paragraph 3.5.2). The 9-bit TOI data shall be encoded into 52-symbol code using Bose, Chaudhuri, and Hocquenghem (BCH) code as defined in paragraph 3.2.3.2.

Subframes 2 and 3 shall utilize 24-bit CRC parity algorithm as defined in paragraph 3.2.3.3 with a separate CRC for each subframe.

Each of the two subframes (2 and 3) shall be further encoded using Low Density Parity Check (LDPC) Forward Error Correction (FEC) code as defined in paragraph 3.2.3.4.

The FEC encoded symbols shall be interleaved, as defined in paragraph 3.2.3.5, prior to being modulo-2 added to $L1C_D$ -code.

The resulting 1800 symbols, $D_{L1C}(t)$, representing one message frame, shall be broadcast at 100 symbols per second.

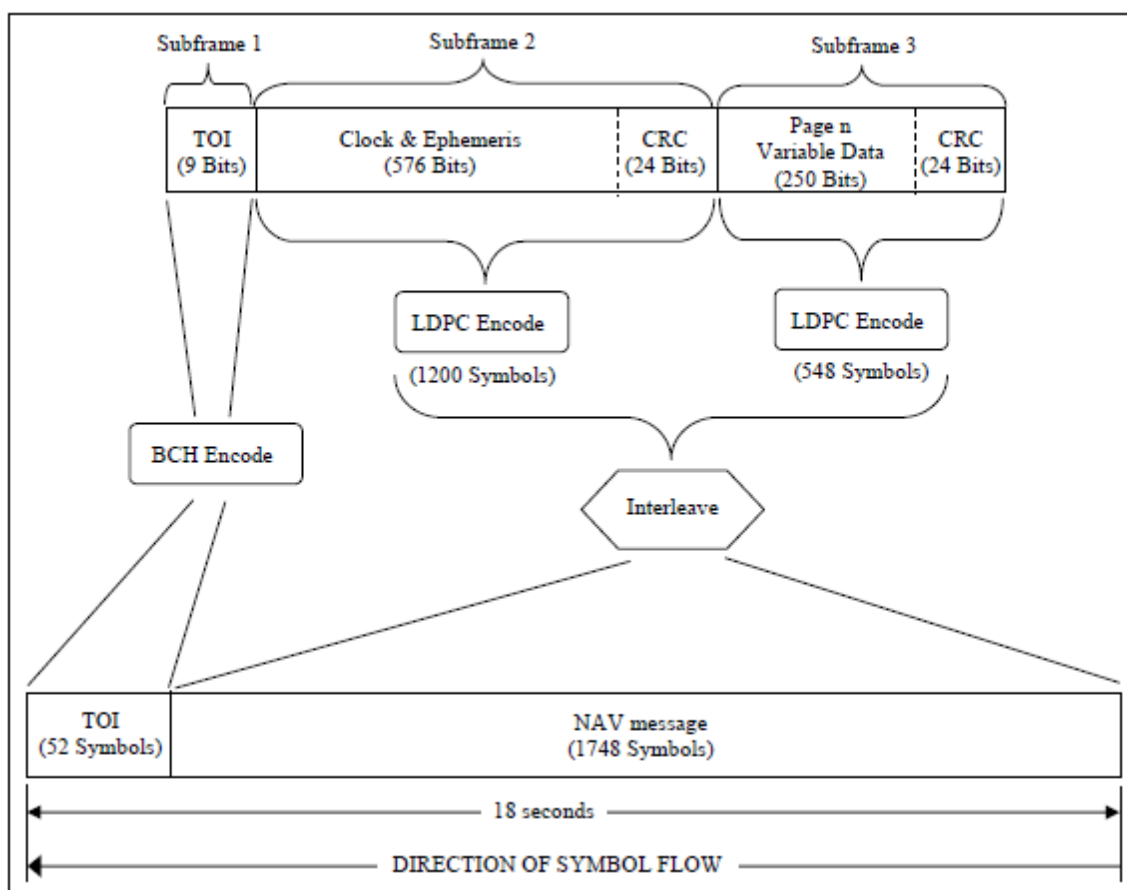

Figure 3.2-3. L1C Message Structure

3.2.3.2 Time of Interval Data Encoding

Nine bits of TOI data are channel encoded using BCH (51, 8) code. The eight Least Significant Bits (LSBs- the rightmost bits) of nine-bit TOI data are encoded using the generator polynomial of 763 (octal). This code generator is conceptually described in Figure 3.2-4 using an 8-stage linear shift register generator. TOI data bits 1 to 8 (8 LSBs) are loaded into the generator, Most Significant Bit (MSB) first, as initial conditions of the registers, which is then shifted 51 times to generate 51 encoded symbols. The ninth bit of TOI data (MSB) shall be modulo-2 added to the 51 encoded symbols and it shall also be appended as the MSB of the 52-symbol TOI message.

The first output symbol of the generator (after modulo-2 added to the ninth bit of TOI data) shall be the second MSB of the 52-symbol TOI message.

The following provides an example decoding technique to decode the TOI data. The 52 UE-received soft decisions are stored as sign/magnitude and correlated, respectively, with the 52 symbols of a TOI code word hypothesis corresponding to MSB = 0. (A SV transmitted 0 is expected to produce a sign of 0.) For each soft decision, the correlation computation adds the magnitude if the sign agrees with the code word hypothesis and subtracts the magnitude otherwise. The correlation computation is repeated for all 256 TOI code word hypotheses. The decision on the eight LSBs corresponds to the TOI code word hypothesis producing the largest absolute value of the correlation. The decision on the MSB is 0 if this largest correlation is positive and 1 otherwise.

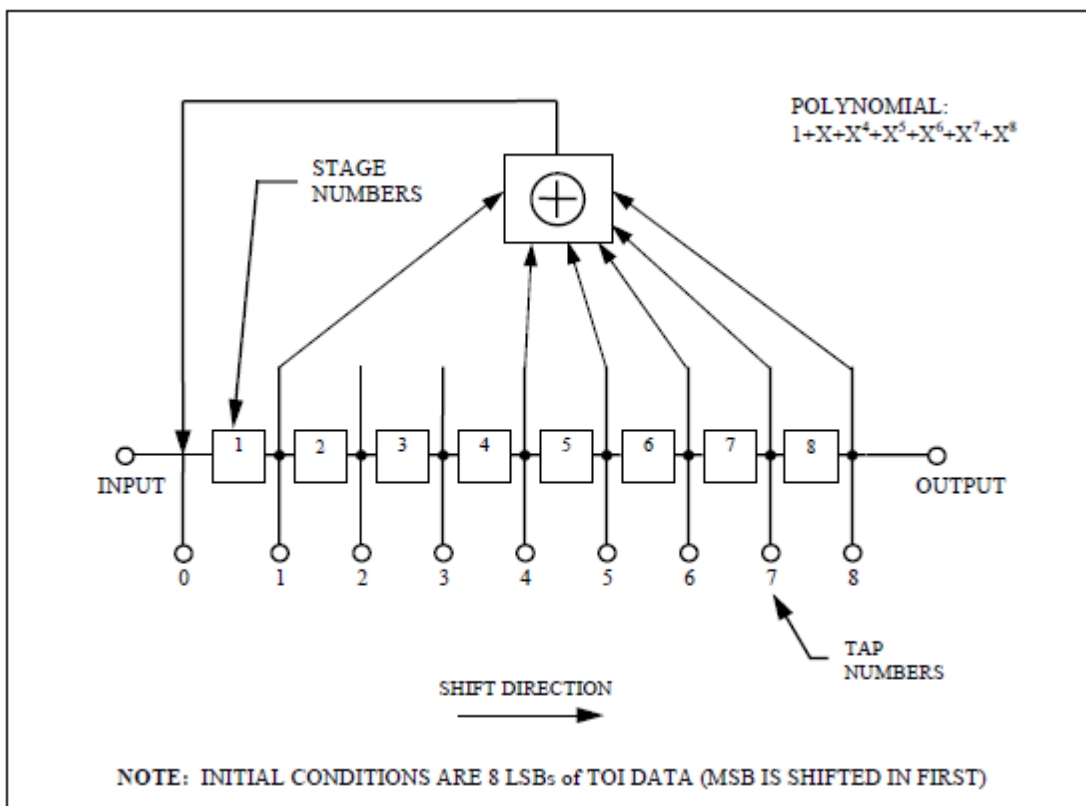

Figure 3.2-4. BCH (51, 8) Code Generator

3.2.3.3 Cyclic Redundancy Check

Twenty-four bits of CRC will provide protection against burst as well as random errors with a probability of undetected error $\leq 2^{-24} = 5.96 \times 10^{-8}$ for all channel bit error probabilities ≤ 0.5 . The CRC word is calculated in the forward direction on a given message using a seed of 0. The sequence of 24 bits $(p_1, p_2, \dots, p_{24})$ is generated from the sequence of information bits (m_1, m_2, \dots, m_k) (MSB to LSB sequence) in a given message. This is done by means of a code that is generated by the polynomial

$$g(X) = \sum_{i=0}^{24} g_i X^i$$

where

$$g_i = \begin{cases} 1 & \text{for } i = 0, 1, 3, 4, 5, 6, 7, 10, 11, 14, 17, 18, 23, 24 \\ 0 & \text{otherwise} \end{cases}$$

This code is called CRC-24Q. The generator polynomial of this code is in the following form (using binary polynomial algebra):

$$g(X) = (1 + X)p(X)$$

where $p(X)$ is the primitive and irreducible polynomial

$$p(X) = X^{23} + X^{17} + X^{13} + X^{12} + X^{11} + X^9 + X^8 + X^7 + X^5 + X^3 + 1$$

When, by the application of binary polynomial algebra, the above $g(X)$ is divided into $m(X)X^{24}$, where the information sequence $m(X)$ is expressed as

$$m(X) = m_k + m_{k-1}X + m_{k-2}X^2 + \dots + m_1X^{k-1}$$

The result is a quotient and a remainder $R(X)$ of degree < 24 . The bit sequence formed by this remainder represents the CRC sequence. CRC bit p_i , for any i from 1 to 24, is the coefficient of X^{24-i} in $R(X)$.

This code has the following characteristics:

It detects all single bit errors per code word.

It detects all double bit error combinations in a codeword because the generator polynomial $g(X)$ has a factor of at least three terms.

It detects any odd number of errors because $g(X)$ contains a factor $1+X$.

It detects any burst error for which the length of the burst is ≤ 24 bits.

It detects most large error bursts with length greater than the CRC length $r = 24$ bits. The fraction of error bursts of length $b > 24$ that are undetected is:

$$2^{-24} = 5.96 \times 10^{-8}, \text{ if } b > 25 \text{ bits}$$

$$2^{-23} = 1.19 \times 10^{-7}, \text{ if } b = 25 \text{ bits}$$

3.2.3.4 Low Density Parity Check (LDPC) Code

Subframe 2 and subframe 3 are separately encoded using rate $\frac{1}{2}$ LDPC codes. Subframe 2 has a total of 600 bits consisting of 576 bits for Clock and Ephemeris and 24 bits for CRC. Subframe 3 has a total of 274 bits consisting of 250 bits for Variable Data and 24 bits for CRC. As a result of rate $\frac{1}{2}$ LDPC encoding, there are 1200 symbols (coded bits) for Subframe 2 and 548 symbols for Subframe 3 as described in Figure 3.2-3.

The LDPC encoder structure is based on a parity-check matrix $H(m, n)$ of m rows and n columns. For Subframe 2, $m = 600$, $n = 1200$ and for Subframe 3, $m = 274$, $n = 548$. $H(m, n)$ is further decomposed into 6 submatrices A, B, T, C, D, and E as shown in Figure 3.2-5 (see reference document [1]). Each element of matrix $H(m, n)$ is either a value of "0" or "1".

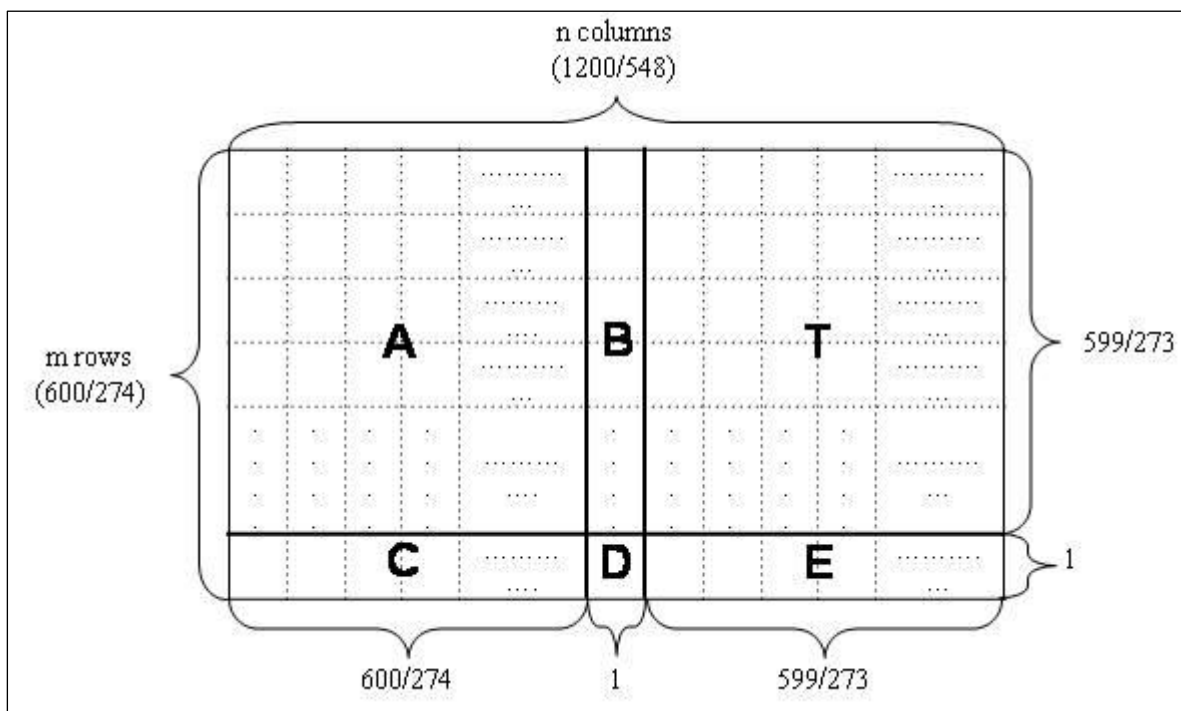

Figure 3.2-5. Parity Check Matrix H for LDPC Code

Tables 6.2-2, 6.2-3, 6.2-4, 6.2-5, 6.2-6, and 6.2-7 shall define the coordinates of elements with value “1” in each of the submatrices A, B, C, D, E, and T, respectively, for Subframe 2.

Tables 6.2-8, 6.2-9, 6.2-10, 6.2-11, 6.2-12, and 6.2-13 shall define the coordinates of elements with value “1” in each of the submatrices A, B, C, D, E, and T, respectively, for Subframe 3.

The inverse of T is not included in this document, however T is a lower triangular matrix and therefore, the inverse of T can be easily identified.

The rate 1/2 LDPC encoder shall use the given matrices A, B, T, C, D, and E of Section 6.2.4 to generate the encoded symbols using the following algorithm:

$$p_1^t = -\phi^{-1} \cdot (-E \cdot T^{-1} \cdot A + C) \cdot s^t$$

$$p_2^t = -T^{-1} \cdot (A \cdot s^t + B \cdot p_1^t)$$

where,

$$\phi = -E \cdot T^{-1} \cdot B + D,$$

s = subframe 2 or subframe 3 data,

[]^t indicates transpose,

and elements of matrices p₁ and p₂ are modulo 2 numbers.

The encoded symbols for broadcast are comprised of (s;p₁;p₂) where s is the systematic portion of the codeword, and {p₁, p₂} comprise the combined parity bits.

The rate 1/2 LDPC encoder shall use the given matrices A, B, T, C, D, and E of Section 6.2.4 to generate the encoded symbols using the following algorithm:

$$p_1^t = -\phi^{-1} \cdot (-E \cdot T^{-1} \cdot A + C) \cdot s^t$$

$$p_2^t = -T^{-1} \cdot (A \cdot s^t + B \cdot p_1^t)$$

where,

$$\phi = -E \cdot T^{-1} \cdot B + D,$$

s = subframe 2 or subframe 3 data,

[]^t indicates transpose,

and elements of matrices p₁ and p₂ are modulo 2 numbers.

The encoded symbols for broadcast are comprised of (s;p₁;p₂) where s is the systematic portion of the codeword, and {p₁, p₂} comprise the combined parity bits.

3.2.3.5 Interleaving

The 1748 encoded symbols of subframes 2 and 3 are combined and interleaved using a block interleaver. The block interleaver is conceptually described using a two-dimensional array of 38 rows and 46 columns, as depicted in Figure 3.2-6. The LDPC encoded subframe 2 symbols are written first (MSB first) into the interleaver from left to right starting at Row 1. After Row 1 is filled, Row 2 is filled from left to right and this process continues until the 1748th symbol (LSB of LDPC encoded subframe 3) is written into the rightmost cell of the last (38th) row. Once all 1748 symbols are written into the array, the symbols are sequentially read out of the array, for broadcast to user, from top to bottom starting at Column 1. After reading out the last symbol of the 38th row in Column 1, Column 2 symbols are read out from top to bottom and this process continues until the last symbol in the 38th row of the last column (46th) is read out.

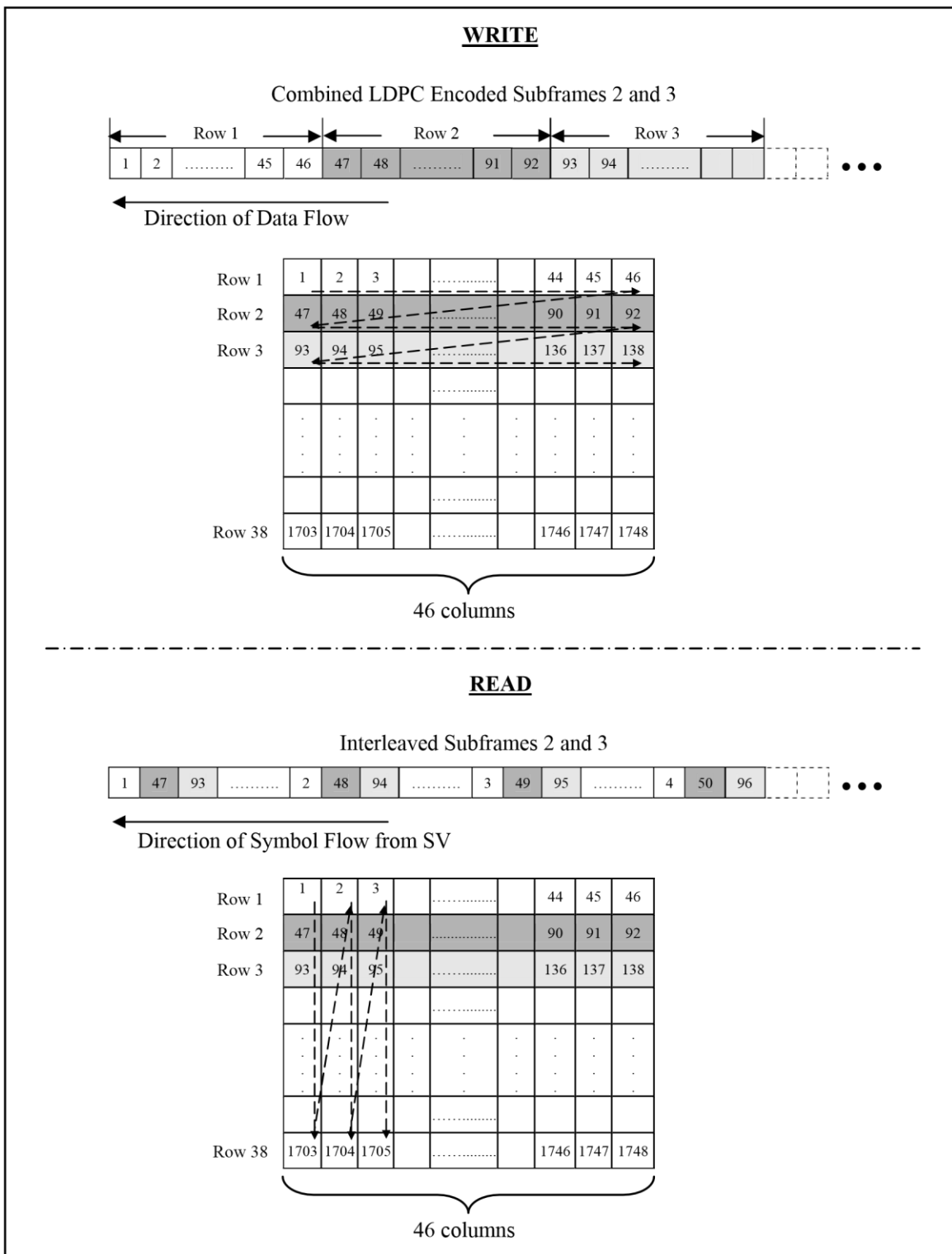

Figure 3.2-6. Conceptual Block Interleaver

3.3 Signal Modulation

The signals modulated on the L1 RF carrier include C/A, P(Y), M, and L1C, which consists of two components: L1C_P and L1C_D. The modulation used is binary offset carrier (BOC) as described in reference document [2]. The modulation is essentially shaped BPSK where a subcarrier is used to shape the spectrum.

The bitstream of the L1C_P signal is constructed by modulo-2 addition of L1C_P-code and L1C_O-code. The overlay code, L1C_O, is described in section 3.2.2.1.2. The PRN ranging codes, L1C_P and L1C_D, are described in section 3.2.2.1.1. The bitstream of L1C_D is constructed by modulo-2 addition of L1C_D-code and the L1C message symbol train, D_{L1C}(t). The timing relationship of L1C signal components is described in Figure 3.3-1.

The bitstream of the L1C_D signal is modulated on L1 carrier frequency using BOC (1, 1) modulation, with a subcarrier frequency of 1.023 MHz and a chipping rate of 1.023 Mbps. Each bit of the bitstream is applied to a BOC (1,1) spreading symbol consisting of one cycle of a 1.023 MHz squarewave, defined as binary 10 (1= positive binary bit value, see Figure 3.3-2a) with total duration 1/1.023 microseconds. The BOC (1,1) spreading symbols are defined using sine-phasing, so they are aligned with the bits of the L1C_D-code. Contrary to convention, a “0” is in-phase with the carrier and a “1” is 180 degrees out of phase with the carrier.

The bitstream of the L1C_P signal is modulated on L1 carrier frequency using TMBOC modulation technique. The L1C_P TMBOC technique uses a mixture of BOC (1, 1) spreading symbols and BOC (6,1) spreading symbols, where each BOC (6,1) spreading symbol consists of 6 cycles of a 6 x 1.023 MHz squarewave, defined as binary 1010101010 (1= binary bit value), with total duration 1/1.023 microseconds (see Figure 3.3-2b).

The pattern of BOC (1,1) and BOC (6,1) spreading symbols repeats every 10230 spreading symbols corresponding to a new bit of L1C_O-code. Let the index of the spreading symbols for L1C_P be $t = 0, 1, \dots, 10229$, where $t = 0$ is the first spreading symbol in the next bit of L1C_O-code. Write t as $t = u_t + 33 v_t$, where $u_t = 0, \dots, 32$ and $v_t = 0, \dots, 309$. Then all spreading symbols in L1C_P are BOC (1,1), except for those that are BOC (6,1) that occur for those t with $u_t = 0, 4, 6, \text{ and } 29$ (i.e., $t = 0, 4, 6, 29, 33, 37, 39, 62, \dots, 10197, 10201, 10203, 10226$). This pattern is shown in Figure 3.3-2c.

The BOC (1,1) and BOC (6,1) spreading symbols are defined using sine-phasing, so they are aligned with the bits of L1C_P-code. The phase relationship between L1C_D and L1C_P is defined in section 3.2.1.6.

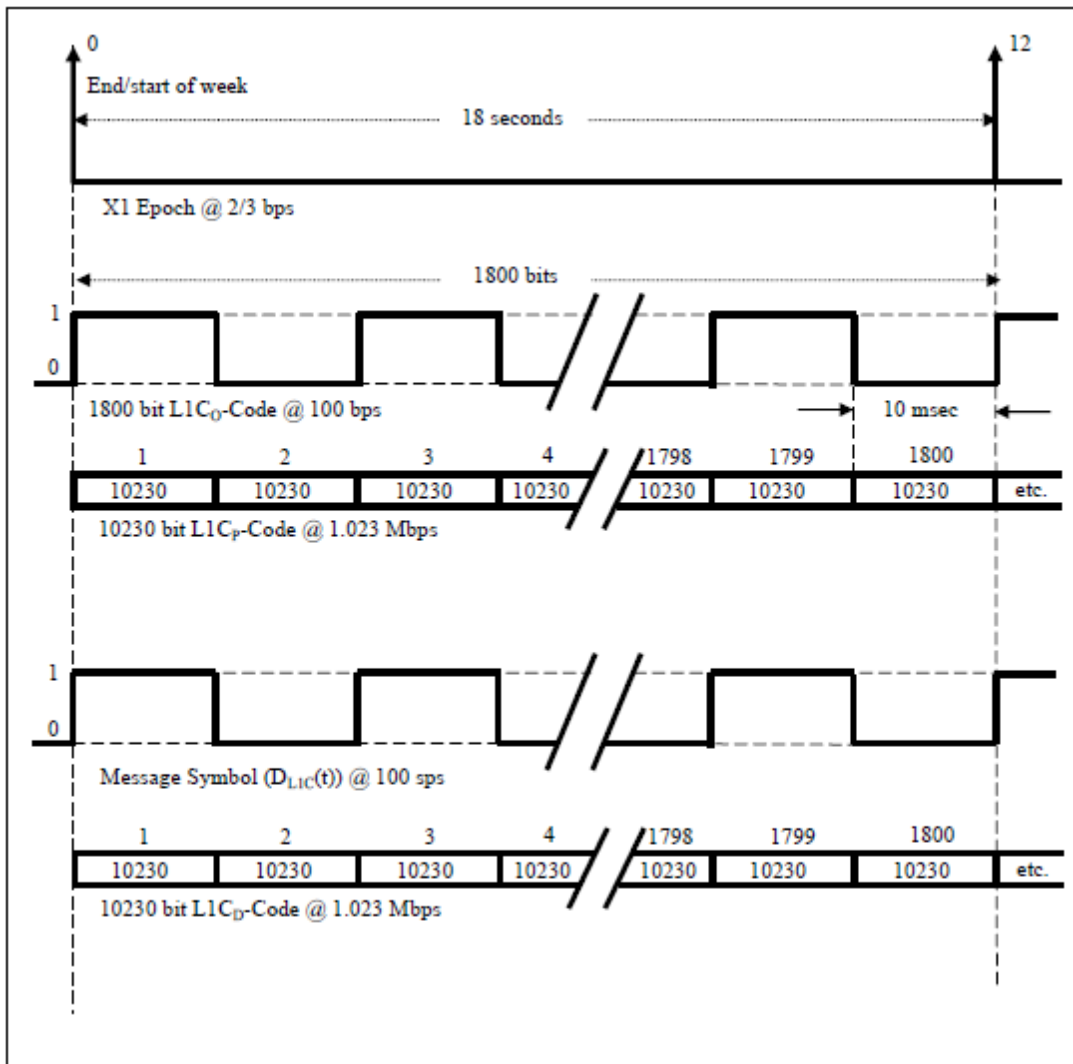

Figure 3.3-1. L1C_p-L1C_d-L1C₀-Code Timing Relationships

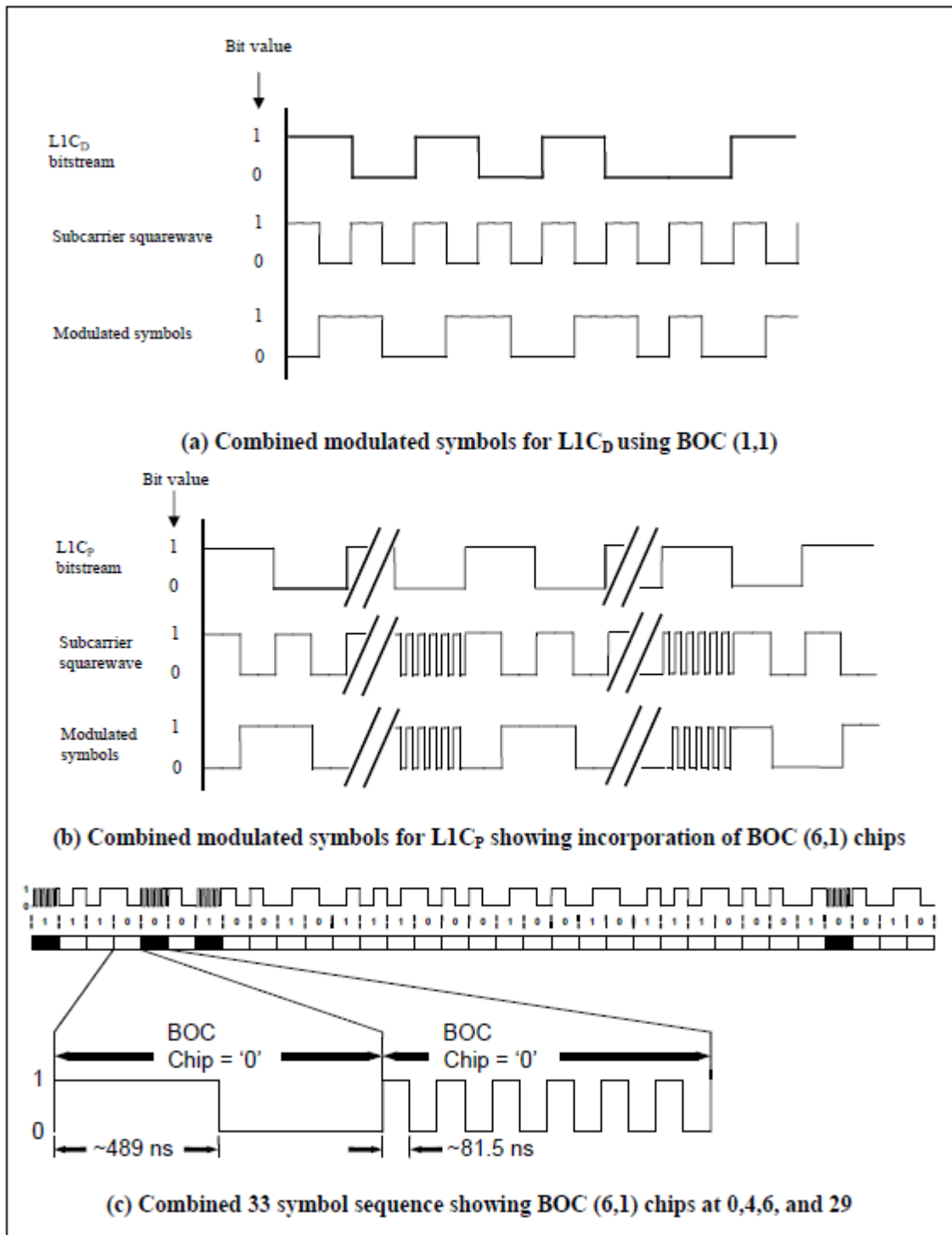

Figure 3.3-2. Subcarrier Polarity Mapping

3.4 Interface Criteria

The following specifies additional criteria for the SS/US interface for the GPS L1C signal.

3.4.1 GPS Time

GPS time is established by the GPS Control Segment and is referenced to Coordinated Universal Time (UTC) as realized by the U.S. Naval Observatory (UTC (USNO)) with zero time-point defined as midnight on the night of January 5, 1980/morning of January 6, 1980. The largest unit used in stating GPS time is one week defined as 604,800 seconds, concatenated with the GPS week number. GPS time may differ from UTC because GPS time is a continuous time scale, while UTC is corrected periodically with an integer number of leap seconds. There also is an inherent but bounded drift rate between the UTC and GPS time scales. The GPS CS shall control the GPS time scale to be within 50 nanoseconds (95% probability) of UTC (USNO) (modulo one second).

The L1C message (henceforth referred to as CNAV-2) contains the requisite data for relating GPS time to UTC. The accuracy of this data during the transmission interval shall be such that it relates GPS time to UTC (USNO) to within 20 nanoseconds (one sigma). This data is generated by the GPS CS; therefore, the accuracy of this relationship may degrade if for some reason the GPS CS is unable to upload data to a SV.

The CNAV-2 data contains thirteen bits representing the sequential number assigned to the current GPS week (see paragraph 6.2.2). The range of this count is from 0 to 8191 with its zero state being defined as the GPS week number zero and every integer multiple of 8192 weeks thereafter (i.e. 0, 8192, 16384, etc.).

3.4.2 SV Time vs. GPS Time

In controlling the SVs and uploading of data, the CS shall allow for the following timing relationships:

Each SV operates on its own SV time;

All TOI and Interval Time of Week (ITOW) in the CNAV-2 messages shall be in SV-time;

All other data in the CNAV-2 messages shall be relative to GPS-time;

The acts of transmitting the CNAV-2 messages shall be executed by the SV on SV time.

3.4.3 Speed of Light

The speed of light used by the CS for generating the data described in the above paragraphs is

$$c = 2.99792458 \times 10^8 \text{ meters per second}$$

which is the official WGS 84 speed of light. The user shall use the same value for the speed of light in all computations.

3.5 Message Definition

As shown in Figure 3.2-3, the L1C message, CNAV-2, structure utilizes three different subframe formats. This section defines and specifies the content of each subframe.

3.5.1 Message Content

Subframe 1 provides TOI count defined as being equal to the number of 18-second epochs that have occurred since the start of current Interval Time of Week (ITOW) epoch (reference Section 3.5.3).

Subframe 2 provides clock and ephemeris data which is nominally invariant over multiple frames. Subframe 2 also provides the ITOW count defined as being equal to the number of two-hour epochs that have occurred since the transition from the previous week.

Subframe 3 provides other navigation data which is commutated over multiple pages. Each page of subframe 3 provides different data as shown in Figures 3.5-2 through 3.5-8a. Additional subframe 3 pages may be defined in the future. It shall be noted that the broadcast sequence of subframe 3 pages is variable and, as such, users must not expect a fixed pattern of page sequence. Subframe 3 provides an 8-bit PRN number of the transmitting SV with a range of 0 (00000000) to 255 (11111111).

In the event of message generation failure, the SV shall replace each affected subframe 2 and/or 3 with the default message.

The data content of the default message shall be alternating ones and zeros beginning with one and the message shall contain a proper CRC block.

In addition, in the event of message generation failure of either subframe 2 or 3, the SV shall replace the content of subframe 1 with the default TOI count (11111111).

The SV shall also broadcast the default TOI count in the event of a subframe 1 message generation failure.

3.5.2 Subframe 1

The TOI count utilizes a 9-bit data word that represents SV time at the start of the next 18-second frame. The count represents the number of 18-second epochs that have occurred since the start of the two-hour period represented by ITOW count in the subframe 2 of the next 18-second frame. The TOI count range is from 0 (000000000) to 399 (110001111). The beginning epoch of a two-hour period shall correspond to a start of subframe 1 and TOI count one (000000001) shall correspond to the start of the next 18-second frame following the beginning of a two-hour period. The TOI data is nominally the same on all SVs (for those SVs that broadcast TOI data).

The 9-bit subframe 1 data is channel encoded into 52 symbols for broadcast as specified in paragraph 3.2.3.2.

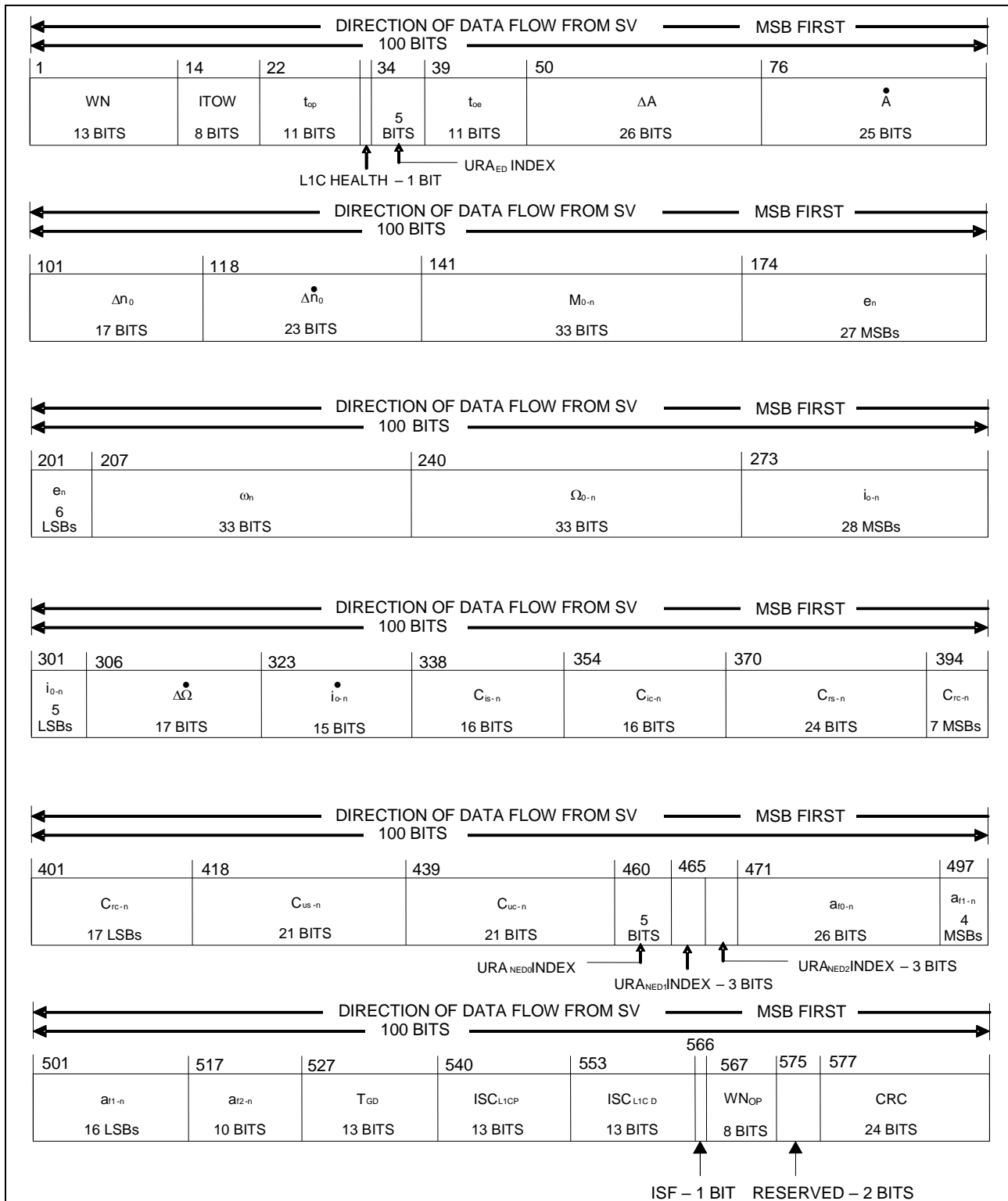

Figure 3.5-1. Subframe 2 - Clock, Ephemeris, ITOW

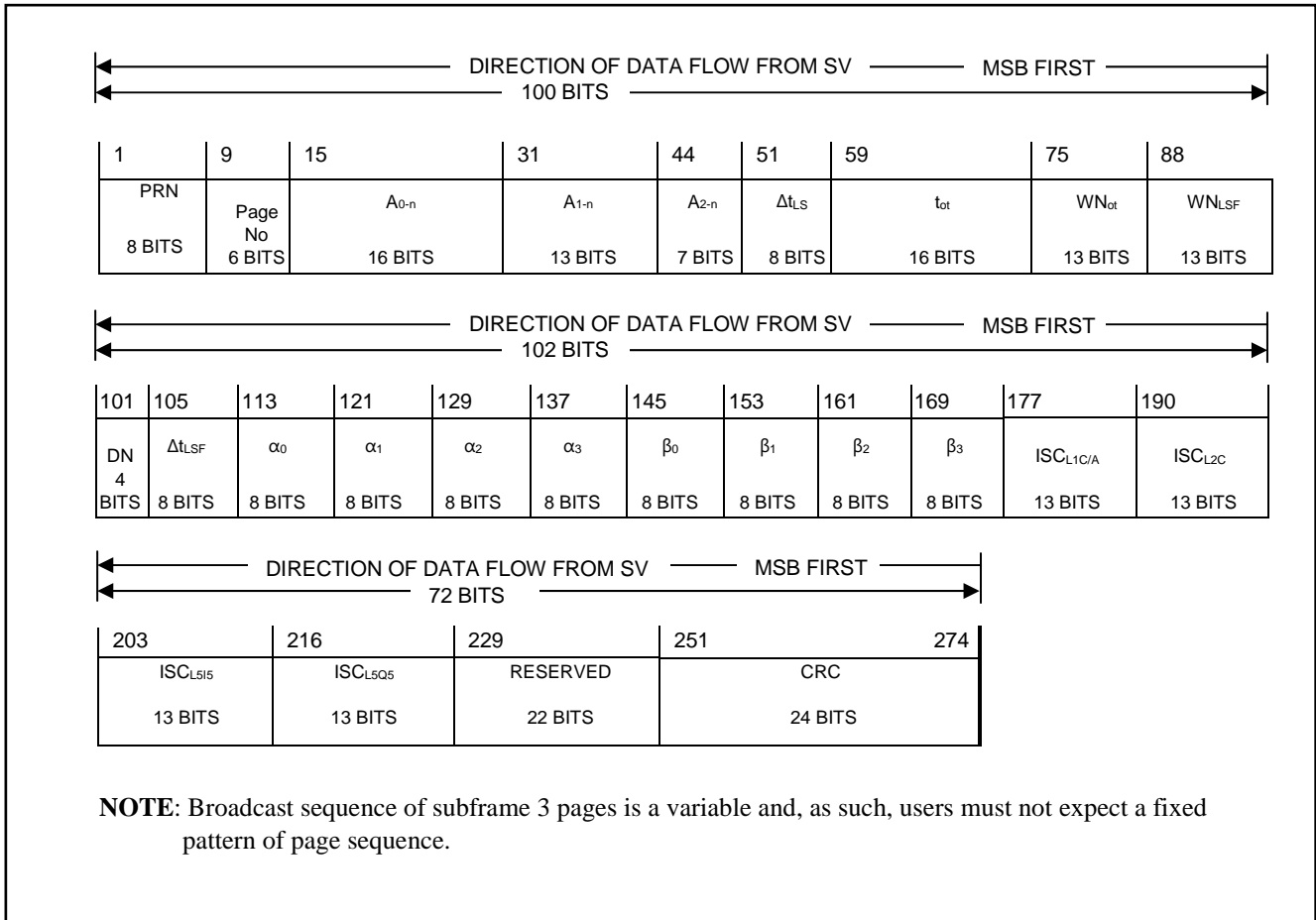

Figure 3.5-2. Subframe 3, Page 1 - UTC & IONO

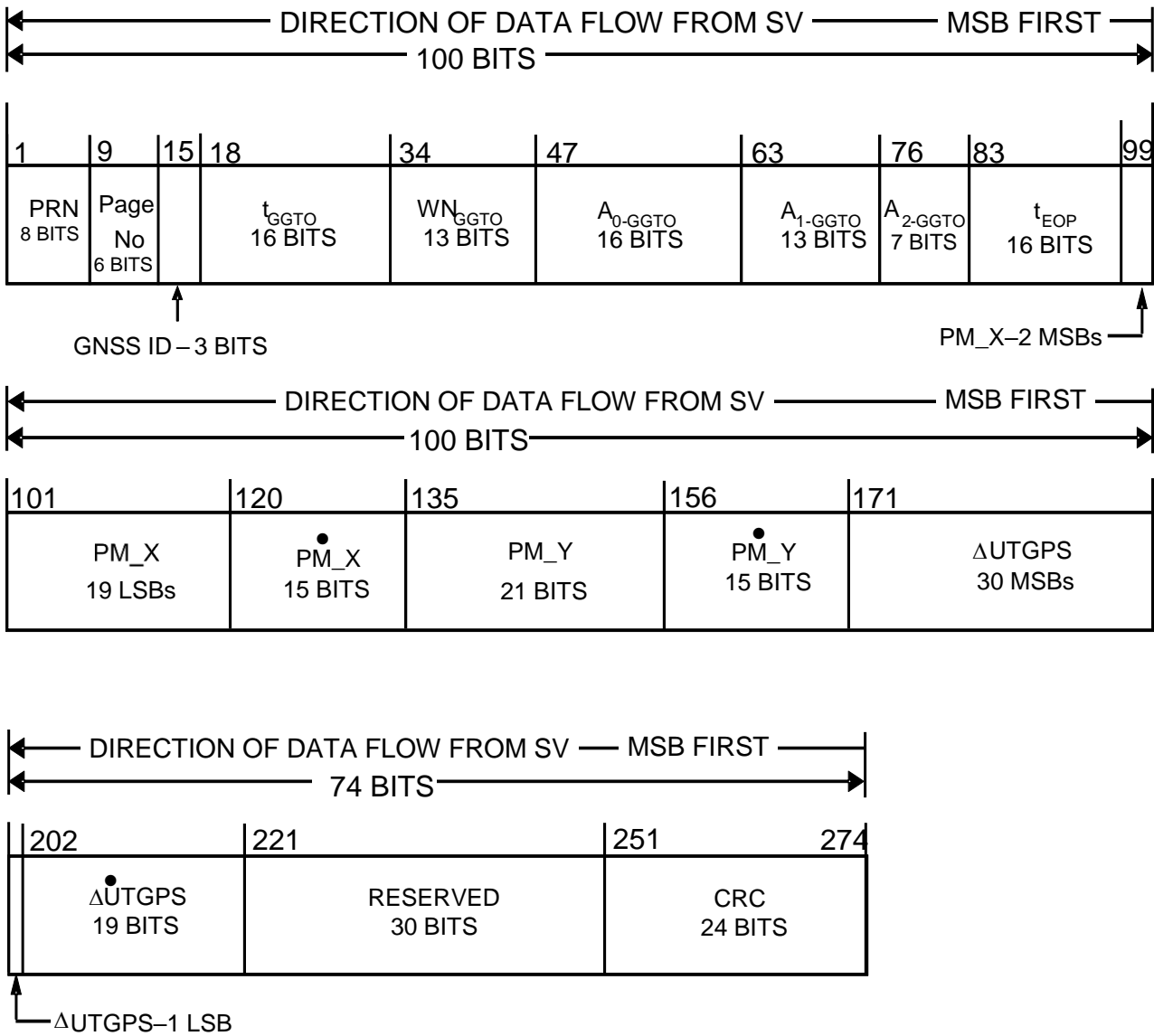

Figure 3.5-3 Subframe 3, Page 2

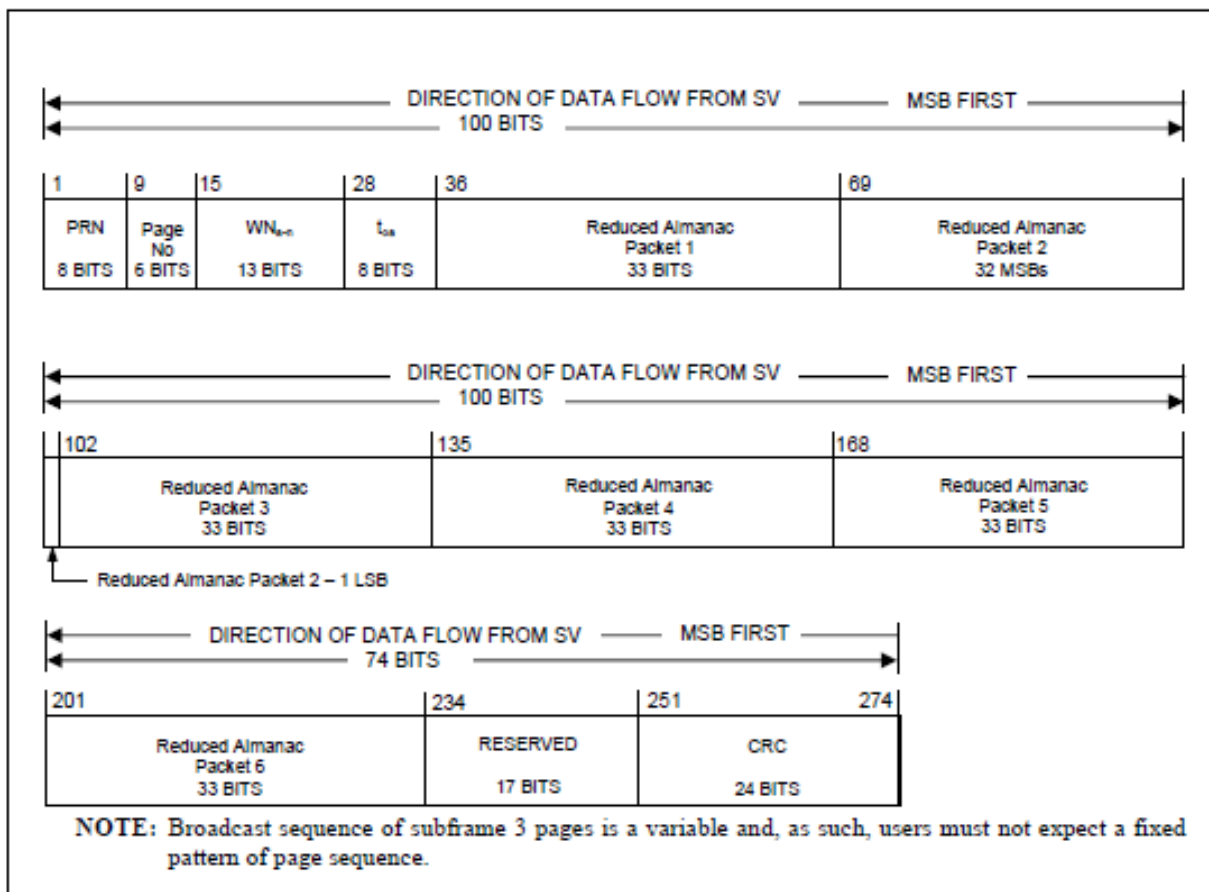

Figure 3.5-4. Subframe 3, Page 3 - Reduced Almanac

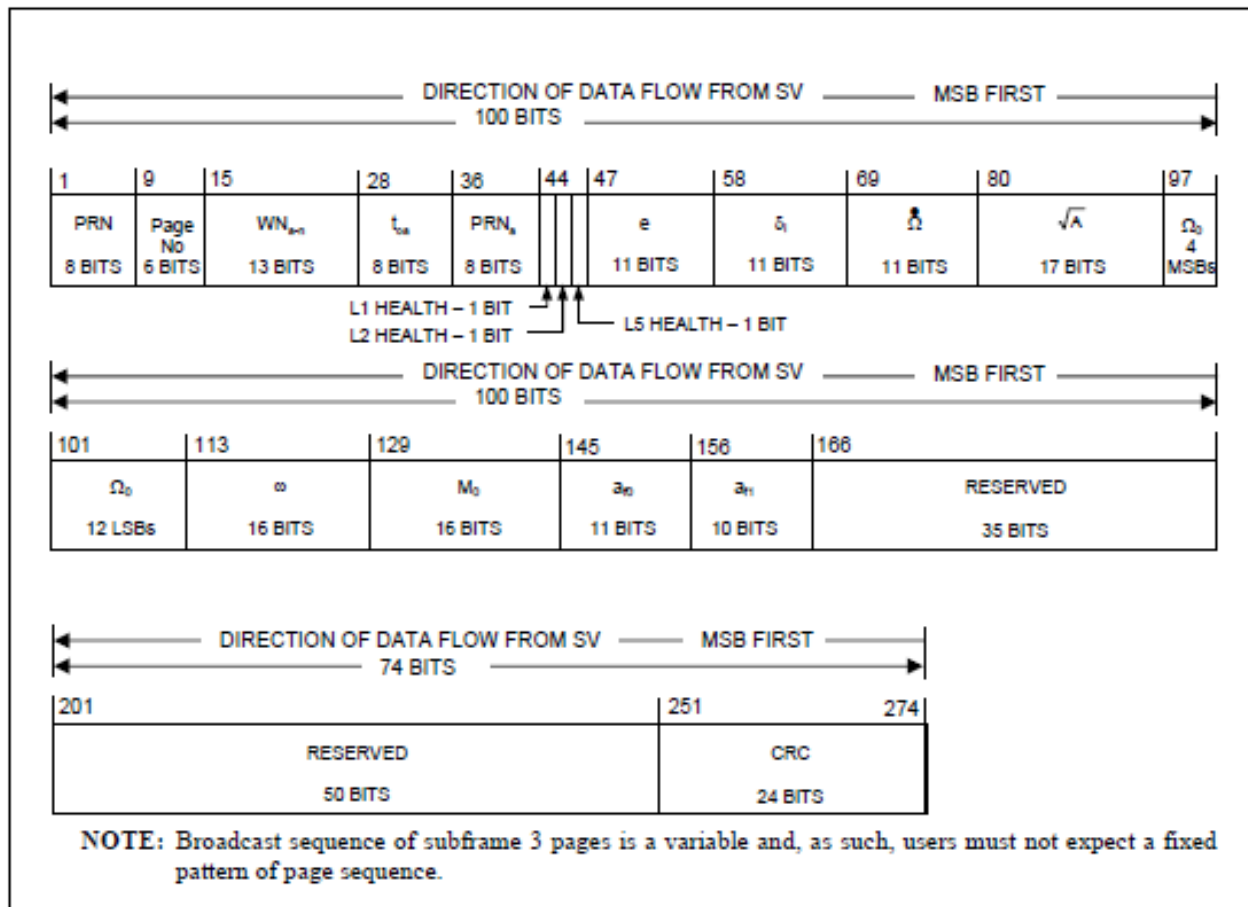

Figure 3.5-5. Subframe 3, Page 4 - Midi Almanac

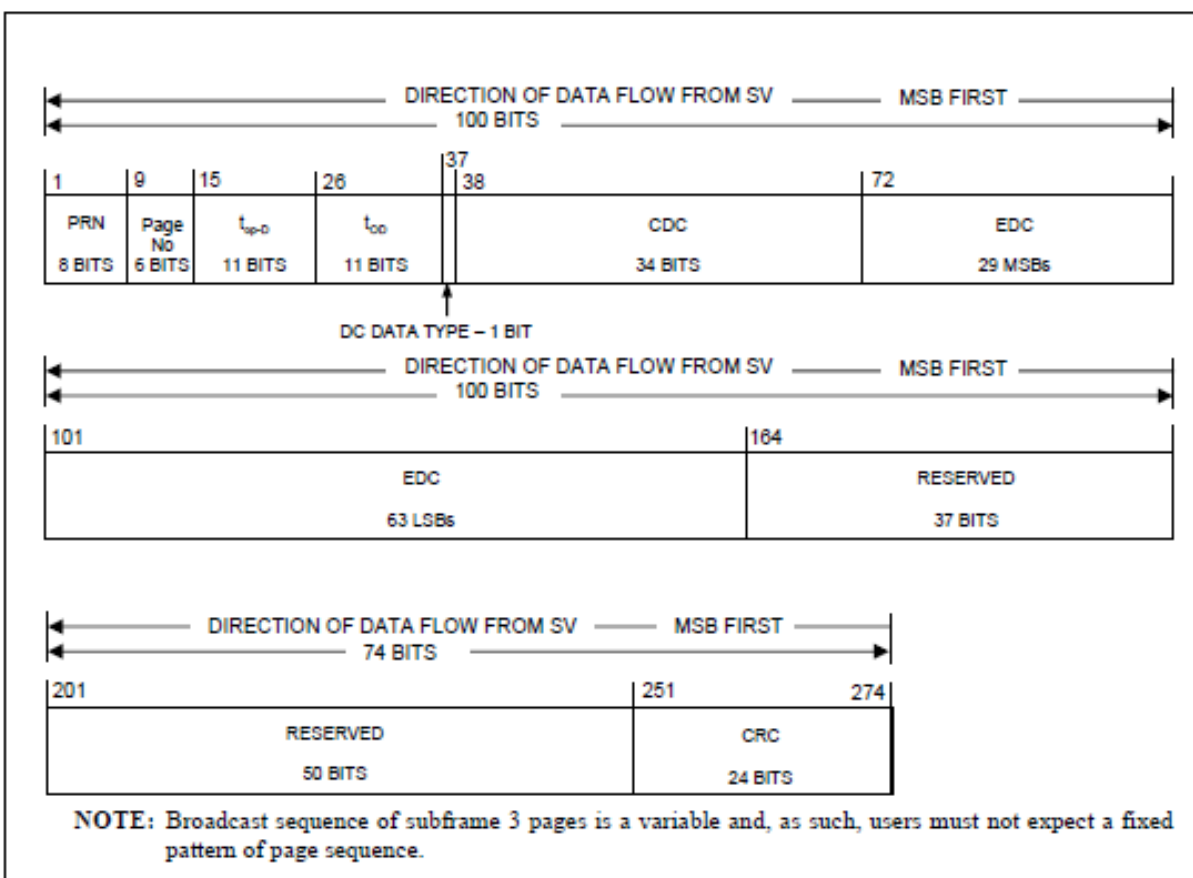

Figure 3.5-6. Subframe 3, Page 5 - Differential Correction

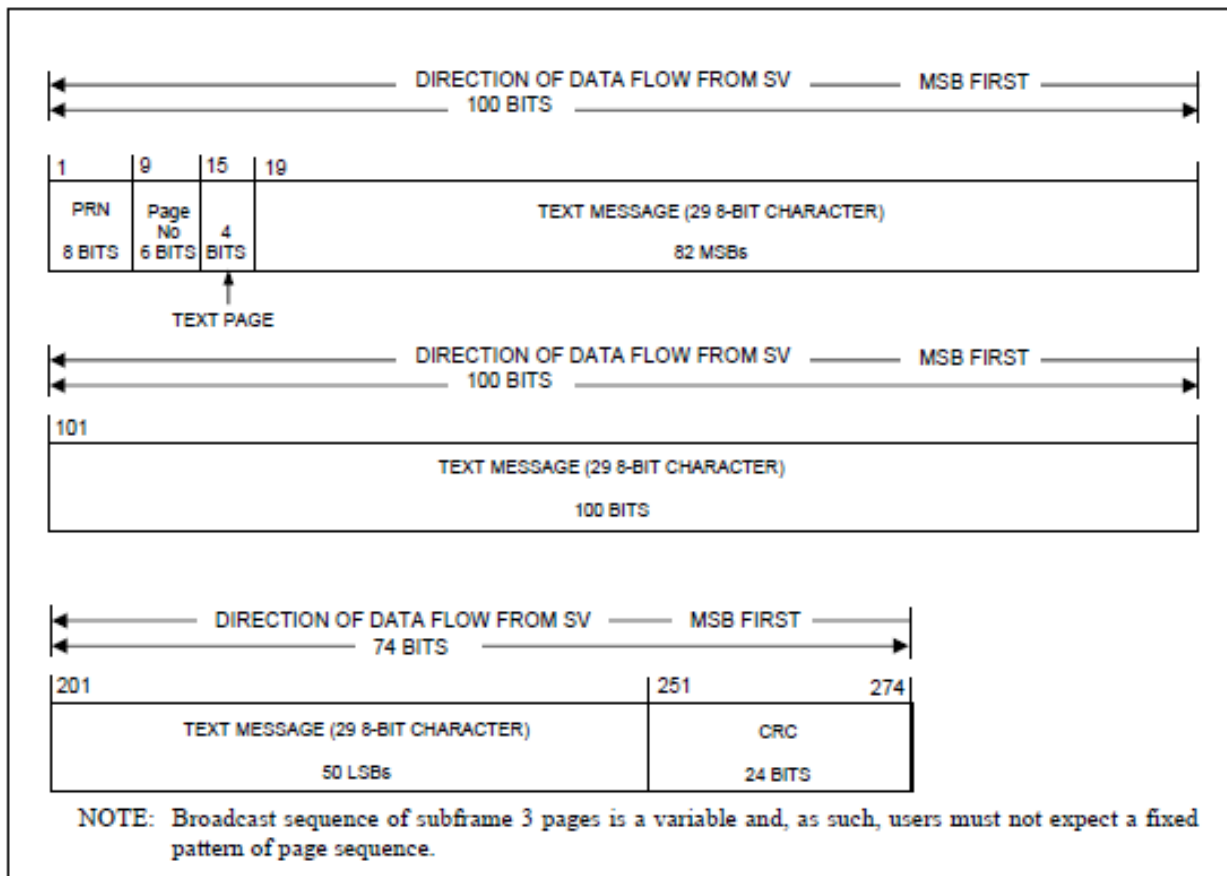
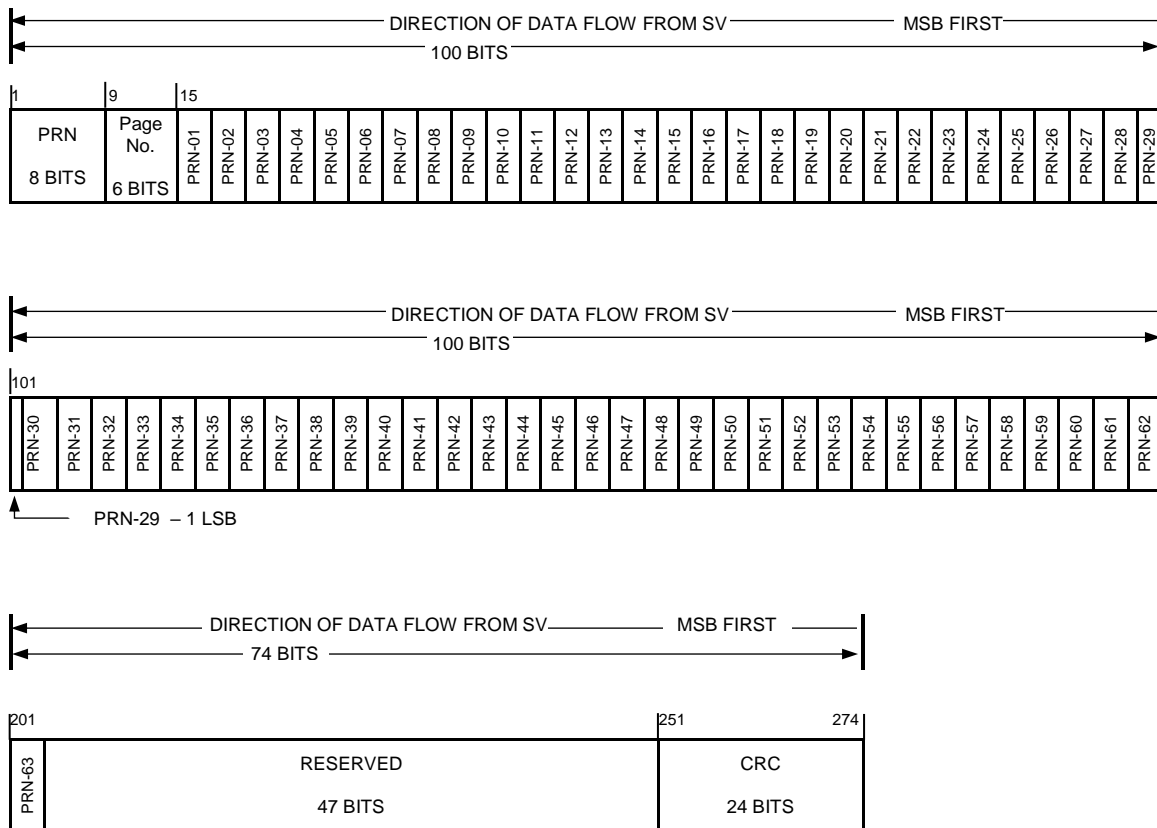
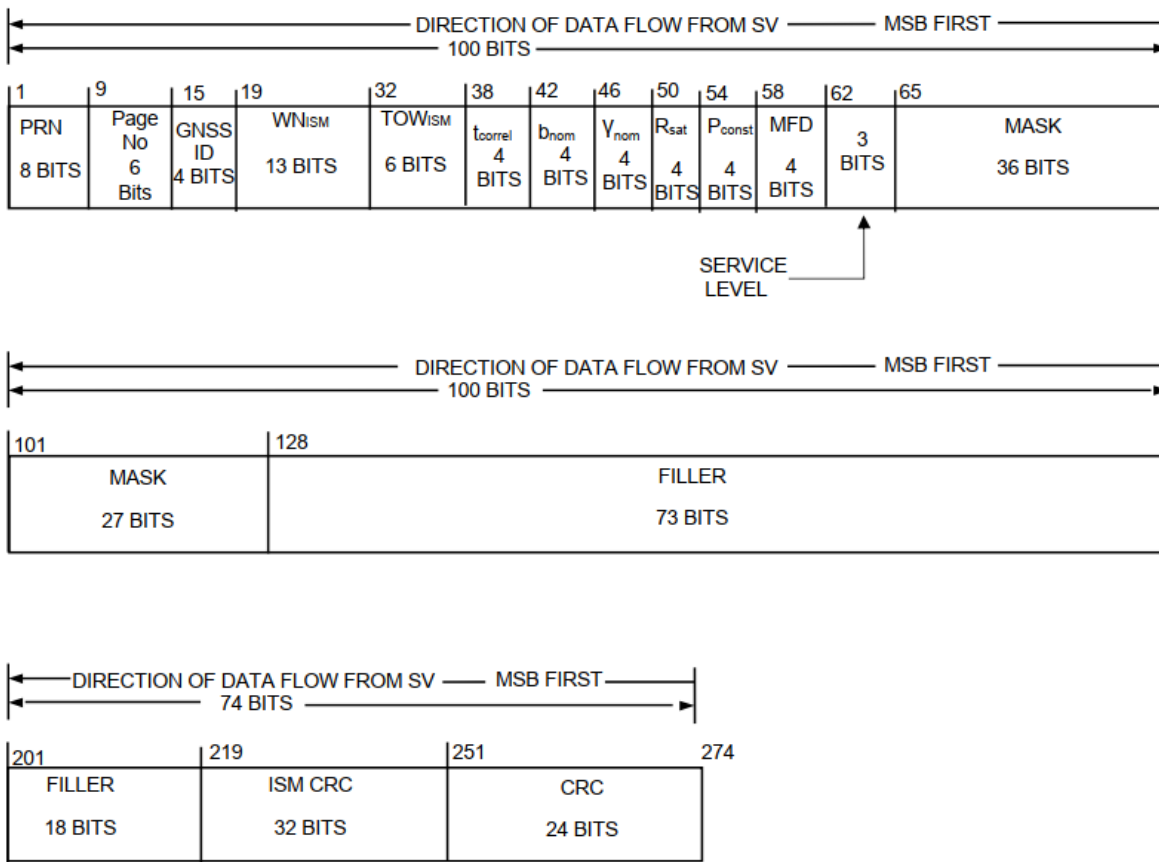

Figure 3.5-7. Subframe 3, Page 6 - Text



NOTE: Broadcast sequence of subframe 3 pages is a variable and, as such, users must not expect a fixed pattern of page sequence

Figure 3.5-8. Subframe 3, Page 7 - SV Configuration



Note: Broadcast sequence of subframe 3 pages is a variable and, as such, users must not expect a fixed pattern of page sequence

Figure 3.5-8a Subframe 3, Page 8, Integrity Support Message

3.5.3 Subframe 2

Subframe 2 provides users with the requisite data to correct SV time and to calculate SV position. Nominally, the subframe 2 data is invariant for the nominal transmission interval of two hours. The contents of the SV ephemeris representation, clock correction, and accuracy parameters are defined below, followed by material pertinent to the use of the data.

The general format of ephemeris data of subframe 2 consists of data fields for reference time tags, a set of gravitational harmonic correction terms, rates and rate corrections to quasi-Keplerian elements, and an accuracy indicator for ephemeris-related data.

The ephemeris parameters describe the orbit of the transmitting SV during the curve fit interval of three hours. The nominal transmission interval is two hours, and shall coincide with the first two hours of the curve fit interval. The period of applicability for ephemeris data coincides with the entire three-hour curve fit interval. Table 3.5-1 gives the definition of the orbital parameters using terminology typical of Keplerian orbital parameters; it is noted, however, that the transmitted parameter values are expressed such that they provide the best trajectory fit in Earth-Centered, Earth-Fixed (ECEF) coordinates for each specific fit interval.

The user shall not interpret intermediate coordinate values as pertaining to any conventional coordinate system.

Any change in the subframe 2 ephemeris and clock data shall be accomplished with a simultaneous change in the t_{oe} value. The SV shall assure that the t_{oe} value, for at least the first CEI data set transmitted by an SV from a new CEI data sequence propagation, is different from that transmitted from the prior CEI data sequence propagation. The eight LSBs of t_{oe} for each CEI data set shall be different from the eight LSBs of t_{oe} transmitted during the previous six hours by the SV.

The general format of clock data in subframe 2 consists of data fields for SV clock correction coefficients. The clock parameters of subframe 2 describe the SV time scale during the period of validity. The parameters are applicable during the time in which they are transmitted. Beyond that time, they are still applicable, however, the most recent CEI data set should be used since the accuracy degrades over time.

Table 3.5-1. Subframe 2 Parameters (1 of 3)

Parameter		No. of Bits**	Scale Factor (LSB)	Valid Range***	Units
WN	Data Sequence Propagation Week Number	13	1		weeks
ITOW	Interval time of week	8		0 to 83	(see text)
t_{op}	CEI Data sequence propagation time of week	11	300	0 to 604,500	seconds
L1C health		1			(see text)
URA _{ED} Index	ED accuracy index	5*			(see text)
t_{oe}	Ephemeris/clock data reference time of week	11	300	0 to 604,500	seconds
ΔA ****	Semi-major axis difference at reference time	26*	2^{-9}		meters
\dot{A}	Change rate in semi-major axis	25*	2^{-21}		meters/sec
Δn_0	Mean Motion difference from computed value at reference time	17*	2^{-44}		semi-circles/sec
$\Delta \dot{n}_0$	Rate of mean motion difference from computed value	23*	2^{-57}		semi-circles/sec ²
M_{0-n}	Mean anomaly at reference time	33*	2^{-32}		semi-circles
e_n	Eccentricity	33	2^{-34}	0.0 to 0.03	dimensionless
ω_n	Argument of perigee	33*	2^{-32}		semi-circles

* Parameters so indicated are in two's complement notation;
** See Figure 3.5-1 for complete bit allocation in Subframe 2;
*** Unless otherwise indicated in this column, valid range is the maximum range attainable with indicated bit allocation and scale factor.
**** Relative to $A_{REF} = 26,559,710$ meters.

Table 3.5-1. Subframe 2 Parameters (2 of 3)

Parameter		No. of Bits**	Scale Factor (LSB)	Valid Range***	Units
Ω_{0-n}	Longitude of Ascending Node of Orbit Plane at Weekly Epoch	33*	2^{-32}		semi-circles
$\dot{\Delta} \bullet$ ****	Rate of right ascension difference	17*	2^{-44}		semi-circles/sec
Ω_{i0-n}	Inclination angle at reference time	33*	2^{-32}		semi-circles
$i_{0-n} - \text{DOT}$	Rate of inclination angle	15*	2^{-44}		semi-circles/sec
C_{is-n}	Amplitude of the sine harmonic correction term to the angle of inclination	16*	2^{-30}		radians
C_{ic-n}	Amplitude of the cosine harmonic correction term to the angle of inclination	16*	2^{-30}		radians
C_{rs-n}	Amplitude of the sine correction term to the orbit radius	24*	2^{-8}		meters
C_{rc-n}	Amplitude of the cosine correction term to the orbit radius	24*	2^{-8}		meters
C_{us-n}	Amplitude of the sine harmonic correction term to the argument of latitude	21*	2^{-30}		radians
C_{uc-n}	Amplitude of the cosine harmonic correction term to the argument of latitude	21*	2^{-30}		radians
<p>* Parameters so indicated are in two's complement notation; ** See Figure 3.5-1 for complete bit allocation in Subframe 2; *** Unless otherwise indicated in this column, valid range is the maximum range attainable with indicated bit allocation and scale factor. **** Relative to $\dot{\Omega}_{\text{REF}} = -2.6 \times 10^{-9}$ semi-circles/second.</p>					

Table 3.5-1. Subframe 2 Parameters (3 of 3)

Parameter		No. of Bits**	Scale Factor (LSB)	Valid Range***	Units
URANED0 Index	NED Accuracy Index	5*			(see text)
URANED1 Index	NED Accuracy Change Index	3			(see text)
URANED2 Index	NED Accuracy Change Rate Index	3			(see text)
a _{f2-n}	SV Clock Drift Rate Correction Coefficient	10*	2 ⁻⁶⁰		sec/sec ²
a _{f1-n}	SV Clock Drift Correction Coefficient	20*	2 ⁻⁴⁸		sec/sec
a _{f0-n}	SV Clock Bias Correction Coefficient	26*	2 ⁻³⁵		seconds
T _{GD}	Inter-Signal Correction for L1 or L2 P(Y)	13*	2 ⁻³⁵		seconds
ISCLICP****	Inter-Signal Correction for L1C _P	13*	2 ⁻³⁵		seconds
ISCLICD****	Inter-Signal Correction for L1C _D	13*	2 ⁻³⁵		seconds
WN _{op}	CEI Data Sequence Propagation Week Number	8	1		weeks
<p>* Parameters so indicated are in two's complement notation; ** See Figure 3.5-1 for complete bit allocation in Subframe 2; *** Unless otherwise indicated in this column, valid range is the maximum range attainable with indicated bit allocation and scale factor.</p>					

3.5.3.1 Transmission Week Number

Bits 1 through 13 of subframe 2 shall contain 13 bits that are a modulo-8192 binary representation of the current GPS week number at the start of the CEI data set transmission interval (see paragraph 6.2.2).

3.5.3.2 ITOW

Bits 14 through 21 of subframe 2 shall contain 8 bits representing ITOW count defined as being equal to the number of two-hour epochs that have occurred since the transition from the previous week. The count is short-cycled such that the range of the ITOW-count is from 0 to 83 2-hour epochs (equaling one week) and is reset to zero at the end of each week. The ITOW-count's zero state is defined as that 2-hour epoch which is coincident with the start of the present week. This epoch occurs at (approximately) midnight Saturday night-Sunday morning, where midnight is defined as 0000 hours on the UTC scale that is nominally referenced to the Greenwich Meridian. The occurrence of the “zero state epoch” may differ by a few seconds from 0000 hours on the UTC scale since UTC is periodically corrected with leap seconds while GPS time is continuous without such correction.

3.5.3.3 CEI Data Sequence Propagation Time of Week.

Bits 22 through 32 of subframe 2 shall contain the CEI data sequence propagation time of week (t_{op}). The t_{op} term provides the epoch time of week of the state data utilized for satellite CEI data. Users are cautioned to avoid using this parameter to compute age of data for any SV.

3.5.3.4 L1C Signal Health

The one-bit health indication in bit 33 of subframe 2 refers to the L1C signal of the transmitting SV. The health of the signal is indicated by:

0 = Signal OK,

1 = Signal bad or unavailable.

The predicted health data will be updated at the time of upload when a new CEI data set has been built by the CS. The transmitted health data may not correspond to the actual health of the transmitting SV. In real time, if the L1C signal becomes unhealthy, the status change will normally be indicated by the broadcast of non-standard code or be indicated by the health bits as described in subframe 2.

Additional SV health data are given in the almanac in subframe 3, pages 3 and 4. The data given in subframe 2 may differ from that shown in other messages of the transmitting SV and/or other SVs since the latter may be updated at a different time. Subframe 2 data is the most reliable; subframe 3 data is intended only to aid acquisition.

3.5.3.5 SV Accuracy

Bits 34 through 38 of subframe 2 shall contain the elevation-dependent (ED) component User Range Accuracy (URA_{ED}) index for the unauthorized user.

The URA_{ED} index shall provide the ED-related URA index for the current ephemeris curve fit interval.

While the ED-related URA may vary over the ephemeris curve fit interval and over the satellite footprint, the URA_{ED} index (N) in subframe 2 shall correspond to the maximum URA_{ED} expected over the entire ephemeris curve fit interval for the worst-case location within the SV footprint (i.e., nominally two points at the edge of the SV footprint). At the best-case location within the SV footprint (i.e., nominally directly below the SV along the SV nadir vector), the corresponding URA_{ED} is zero.

The URA_{ED} index is a signed, two's complement integer in the range of +15 to -16 and has the following relationship to the ED URA:

URA_{ED} Index	URA_{ED} (meters)
15	6144.00 < URA_{ED} (or no accuracy prediction is available)
14	3072.00 < URA_{ED} ≤ 6144.00
13	1536.00 < URA_{ED} ≤ 3072.00
12	768.00 < URA_{ED} ≤ 1536.00
11	384.00 < URA_{ED} ≤ 768.00
10	192.00 < URA_{ED} ≤ 384.00
9	96.00 < URA_{ED} ≤ 192.00
8	48.00 < URA_{ED} ≤ 96.00
7	24.00 < URA_{ED} ≤ 48.00
6	13.65 < URA_{ED} ≤ 24.00
5	9.65 < URA_{ED} ≤ 13.65
4	6.85 < URA_{ED} ≤ 9.65
3	4.85 < URA_{ED} ≤ 6.85
2	3.40 < URA_{ED} ≤ 4.85
1	2.40 < URA_{ED} ≤ 3.40
0	1.70 < URA_{ED} ≤ 2.40
-1	1.20 < URA_{ED} ≤ 1.70
-2	0.85 < URA_{ED} ≤ 1.20
-3	0.60 < URA_{ED} ≤ 0.85

-4	0.43	$< \text{URA}_{\text{ED}} \leq$	0.60
-5	0.30	$< \text{URA}_{\text{ED}} \leq$	0.43
-6	0.21	$< \text{URA}_{\text{ED}} \leq$	0.30
-7	0.15	$< \text{URA}_{\text{ED}} \leq$	0.21
-8	0.11	$< \text{URA}_{\text{ED}} \leq$	0.15
-9	0.08	$< \text{URA}_{\text{ED}} \leq$	0.11
-10	0.06	$< \text{URA}_{\text{ED}} \leq$	0.08
-11	0.04	$< \text{URA}_{\text{ED}} \leq$	0.06
-12	0.03	$< \text{URA}_{\text{ED}} \leq$	0.04
-13	0.02	$< \text{URA}_{\text{ED}} \leq$	0.03
-14	0.01	$< \text{URA}_{\text{ED}} \leq$	0.02
-15		$\text{URA}_{\text{ED}} \leq$	0.01
-16	No accuracy prediction available-use at own risk		

For each URA_{ED} index (N), users may compute a nominal URA_{ED} value (X) as given by:

- If the value of N is 6 or less, but more than -16, $X = 2^{(1 + N/2)}$,
- If the value of N is 6 or more, but less than 15, $X = 2^{(N - 2)}$,
- N = -16 or N = 15 shall indicate the absence of an accuracy prediction and shall advise the standard positioning service user to use that SV at his own risk.

For N = 1, 3, and 5, X should be rounded to 2.8, 5.7, and 11.3 meters, respectively.

The nominal URA_{ED} value (X) is suitable for use as a conservative prediction of the RMS ED range errors for accuracy-related purposes in the pseudorange domain (e.g., measurement deweighting, RAIM, FOM computations). Integrity properties of the IAURA_{ED} are specified with respect to the scaled (multiplied by either 4.42 or 5.73 as appropriate) upper bound values of the broadcast URA_{ED} index (see 30.3.3.1.1).

For the nominal URA_{ED} value and the IAURA_{ED} value, users may compute an adjusted URA_{ED} value as a function of SV elevation angle (E), for $E \geq 0$, as follows:

$$\text{Adjusted Nominal } \text{URA}_{\text{ED}} = \text{Nominal } \text{URA}_{\text{ED}} (\sin(E+90 \text{ degrees}))$$

$$\text{Adjusted } \text{IAURA}_{\text{ED}} = \text{IAURA}_{\text{ED}} (\sin(E+90 \text{ degrees}))$$

URA_{ED} and IAURA_{ED} account for SIS contributions to user range error which include, but are not limited to, the following: LSB representation/truncation error, alongtrack ephemeris errors, and crosstrack ephemeris errors. URA_{ED} and IAURA_{ED} do not account for user range error contributions due to the inaccuracy of the broadcast ionospheric data parameters used in the single-frequency ionospheric model or for other atmospheric effects.

3.5.3.6 Ephemeris Parameter Characteristics

For each ephemeris parameter contained in subframe 2, the bit lengths, scale factors, ranges, and units are given in Table 3.5-1. See Figure 3.5-1 for complete bit allocation in subframe 2.

3.5.3.6.1 User Algorithm for Determination of SV Position

The user shall compute the ECEF coordinates of position for the SV's antenna phase center (APC) utilizing a variation of the equations shown in Table 3.5-2. The ephemeris parameters are Keplerian in appearance; however, the values of these parameters are produced by the SV via a least squares curve fit of the propagated ephemeris of the SV APC (time-position quadruples: t , x , y , z expressed in ECEF coordinates). Particulars concerning the applicable coordinate system are given in Sections 20.3.3.4.3.3 and 20.3.3.4.3.4 of IS-GPS-200.

The user can compute velocity and acceleration for the SV utilizing a variation of the equations, as required, shown in Table 3.5- 2 Part 3 and 4.

The sensitivity of the SV's position to small perturbations in most ephemeris parameters is extreme. The sensitivity of position to the parameters A , C_{rc-n} , and C_{rs-n} is about one meter/meter. The sensitivity of position to the angular parameters is on the order of 10^8 meters/semi-circle, and to the angular rate parameters is on the order of 10^{12} meters/semi-circle/second. Because of this extreme sensitivity to angular perturbations, the value of π used in the curve fit is given here. π is a mathematical constant, the ratio of a circle's circumference to its diameter. Here π is taken as 3.1415926535898.

Table 3.5-2. Broadcast Navigation User Equations (sheet 1 of 4)

Element/Equation	Description
$\mu = 3.986005 \times 10^{14} \text{ meters}^3/\text{sec}^2$	WGS 84 value of the earth's gravitational constant for GPS user
$\dot{\Omega}_e = 7.2921151467 \times 10^{-5} \text{ rad/sec}$	WGS 84 value of the earth's rotation rate
$A_0 = A_{REF} + \Delta A$ *	Semi-Major Axis at reference time
$A_k = A_0 + (\dot{A}) t_k$	Semi-Major Axis
$n_0 = \sqrt{\frac{\mu}{A_0^3}}$	Computed Mean Motion (rad/sec)
$t_k = t - t_{oe}$ **	Time from ephemeris reference time
$\Delta n_A = \Delta n_0 + \frac{1}{2} \Delta \dot{n}_0 t_k$	Mean motion difference from computed value
$n_A = n_0 + \Delta n_A$	Corrected Mean Motion
$M_k = M_0 + n_A t_k$	Mean Anomaly
	Kepler's equation ($M_k = E_k - e \sin E_k$) may be solved for Eccentric anomaly (E_k) by iteration:
$E_0 = M_k$	– Initial Value (radians)
$E_j = E_{j-1} + \frac{M_k - E_{j-1} + e \sin E_{j-1}}{1 - e \cos E_{j-1}}$	– Refined Value, minimum of three iterations, (j=1,2,3)
$E_k = E_j$	– Final Value (radians)
$v_k = 2 \tan^{-1} \left(\sqrt{\frac{1+e}{1-e}} \tan \frac{E_k}{2} \right)$	True Anomaly (unambiguous quadrant)
<p>* $A_{REF} = 26,559,710$ meters</p> <p>** t is GPS system time at time of transmission, i.e., GPS time corrected for transit time (range/speed of light). Furthermore, t_k shall be the actual total difference between the time t and the epoch time t_{oe}, and must account for beginning or end of week crossovers. That is if t_k is greater than 302,400 seconds, subtract 604,800 seconds from t_k. If t_k is less than -302,400 seconds, add 604,800 seconds to t_k.</p>	

Table 3.5-2. Broadcast Navigation User Equations (sheet 2 of 4)

Element/Equation	Description
$\Phi_k = v_k + \omega_n$ $\delta u_k = C_{us-n} \sin 2\Phi_k + C_{uc-n} \cos 2\Phi_k$ $\delta r_k = C_{rs-n} \sin 2\Phi_k + C_{rc-n} \cos 2\Phi_k$ $\delta i_k = C_{is-n} \sin 2\Phi_k + C_{ic-n} \cos 2\Phi_k$	Argument of Latitude Argument of Latitude Correction Radial Correction Inclination Correction } Second Harmonic Perturbations
$u_k = \Phi_k + \delta u_k$	Corrected Argument of Latitude
$r_k = A_k(1 - e_n \cos E_k) + \delta r_k$	Corrected Radius
$i_k = i_{o-n} + (i_{o-n} - \text{DOT})t_k + \delta i_k$	Corrected Inclination
$x_k' = r_k \cos u_k$ $y_k' = r_k \sin u_k$ }	Positions in orbital plane
$\dot{\Omega} = \dot{\Omega}_{\text{REF}} + \Delta \dot{\Omega} \quad \text{***}$	Rate of Right Ascension
$\Omega_k = \Omega_{0-n} + (\dot{\Omega} - \dot{\Omega}_e) t_k - \dot{\Omega}_e t_{oe}$	Corrected Longitude of Ascending Node
$x_k = x_k' \cos \Omega_k - y_k' \cos i_k \sin \Omega_k$ $y_k = x_k' \sin \Omega_k + y_k' \cos i_k \cos \Omega_k$ $z_k = y_k' \sin i_k$ }	Earth-fixed coordinates of SV antenna phase center
*** $\dot{\Omega}_{\text{REF}} = -2.6 \times 10^{-9}$ semi-circles/second.	

Table 3.5-2. Broadcast Navigation User Equations (sheet 3 of 4)

Element/Equation	Description
<u>SV Velocity</u>	
$\dot{E}_k = n / (1 - e \cos E_k)$	Eccentric Anomaly Rate
$\dot{\nu}_k = \dot{E}_k \sqrt{1 - e^2} / (1 - e \cos E_k)$	True Anomaly Rate
$(di_k / dt) = (IDOT) + 2 \dot{\nu}_k (c_{is} \cos 2\phi_k - c_{ic} \sin 2\phi_k)$	Corrected Inclination Angle Rate
$\dot{u}_k = \dot{\nu}_k + 2\dot{\nu}_k (c_{us} \cos 2\phi_k - c_{uc} \sin 2\phi_k)$	Corrected Argument of Latitude Rat
$\dot{r}_k = \dot{A}(1 - e \cos(E_k)) + A e \sin(E_k) \dot{E}_k + 2(c_{rs} \cos(2\phi_k) - c_{rc} \sin(2\phi_k)) \dot{\nu}_k$	Corrected Radius Rate for CNAV-2
$\dot{\Omega}_k = \dot{\Omega} - \dot{\Omega}_e$	Longitude of Ascending Node Rate
$\dot{x}'_k = \dot{r}_k \cos u_k - r_k \dot{u}_k \sin u_k$	In- plane x velocity
$\dot{y}'_k = \dot{r}_k \sin u_k + r_k \dot{u}_k \cos u_k$	In- plane y velocity
$\dot{x}_k = -x'_k \dot{\Omega}_k \sin \Omega_k + \dot{x}'_k \cos \Omega_k - \dot{y}'_k \sin \Omega_k \cos i_k - y'_k (\dot{\Omega}_k \cos \Omega_k \cos i_k - (di_k / dt) \sin \Omega_k \sin i_k)$	Earth- Fixed x velocity (m/s)
$\dot{y}_k = x'_k \dot{\Omega}_k \cos \Omega_k + \dot{x}'_k \sin \Omega_k + \dot{y}'_k \cos \Omega_k \cos i_k - y'_k (\dot{\Omega}_k \sin \Omega_k \cos i_k + (di_k / dt) \cos \Omega_k \sin i_k)$	Earth- Fixed y velocity (m/s)
$\dot{z}_k = \dot{y}'_k \sin i_k + y'_k (di_k / dt) \cos i_k$	Earth- Fixed z velocity (m/s)

Table 3.5-2. Broadcast Navigation User Equations (sheet 4 of 4)

Element/Equation	Description
<u>SV Acceleration</u>	
$R_E = 6378137.0$ meters	WGS 84 Earth Equatorial Radius
$J_2 = 0.0010826262$	Oblate Earth Gravity Coefficient
$F = - (3/2) J_2 (\mu / r_k^2) (R_E / r_k)^2$	Oblate Earth acceleration Factor
$\ddot{x}_k = - \mu (x_k / r_k^3) + F [(1 - 5 (z_k / r_k)^2)(x_k / r_k)] + 2\dot{y}_k \dot{\Omega}_e + x_k \dot{\Omega}_e^2$	Earth- Fixed x acceleration (m/s ²)
$\ddot{y}_k = - \mu (y_k / r_k^3) + F [(1 - 5 (z_k / r_k)^2)(y_k / r_k)] - 2\dot{x}_k \dot{\Omega}_e + y_k \dot{\Omega}_e^2$	Earth- Fixed y Acceleration (m/s ²)
$\ddot{z}_k = - \mu (z_k / r_k^3) + F [(3 - 5 (z_k / r_k)^2)(z_k / r_k)]$	Earth- Fixed z Acceleration (m/s ²)

3.5.3.7 Clock Parameter Characteristics

The bit lengths, scale factors, ranges, and units of the clock correction parameters shall be as specified in Table 3.5-1.

3.5.3.7.1 User Algorithms for SV Clock Correction Data

The algorithms defined in paragraph 20.3.3.3.3.1 of IS-GPS-200 allow all users to correct the code phase time received from the SV with respect to both SV code phase offset and relativistic effects. However, since the SV clock corrections of equations in paragraph 20.3.3.3.3.1 of IS-GPS-200 are estimated by the CS using dual frequency L1 P(Y) and L2 P(Y) code measurements, the single-frequency (L1) user and the dual-frequency (L1/L2 and L1/L5) user must apply additional terms to the SV clock correction equations. These terms are described in paragraph 3.5.3.9. In addition, users shall use t_{oe} , provided in bits 39 through 49 of subframe 2, to replace t_{oc} in the algorithms in paragraph 20.3.3.3.3.1 of IS-GPS-200. Refer to IS-GPS-200, Section 20.3.3.3.3.1.0-2.1 for optional first and second derivative of the SV clock correction equation.

3.5.3.8 Non-Elevation Dependent (NED) Accuracy Estimates

Bits 460 through 470 of subframe 2 shall contain the URA_{NED0} Index, URA_{NED1} Index, and URA_{NED2} Index of the SV (reference paragraph 6.2.1) for the user.

The following equations together with the broadcast URA_{NED0} Index, URA_{NED1} Index, and URA_{NED2} Index shall give the clock-related user range accuracy of $IAURA_{NED}$ over the current clock/ephemeris fit interval. While the actual NED-related URA may vary over the satellite footprint, the $IAURA_{NED}$ calculated using the parameters in subframe 2 at each instant during the current clock/ephemeris fit interval shall bound the maximum $IAURA_{NED}$ expected for the worst-case location within the satellite footprint at that instant.

Non-elevation dependent (URA_{NED}) accounts for signal-in-space contributions to user range error that include, but are not limited to, the following: the net effect of clock parameter and code phase error in the transmitted signal for single-frequency users who correct the code phase as described in Section 3.5.3.9.1, as well as the net effect of clock parameter, code phase, and intersignal correction error for dual-frequency L1/L2 and L1/L5 users who correct for group delay and ionospheric effects as described in Section 3.5.3.9.2 and Section 3.5.3.9.3.

The user shall calculate the NED-related URA with the equation (in meters);

$$IAURA_{NED} = URA_{NED0} + URA_{NED1} (t - t_{op} + 604,800 * (WN - WN_{op}))$$

for $t - t_{op} + 604,800 * (WN - WN_{op}) \leq 93,600$ seconds

$$IAURA_{NED} = URA_{NED0} + URA_{NED1} * (t - t_{op} + 604,800 * (WN - WN_{op})) + URA_{NED2} * (t - t_{op} + 604,800 * (WN - WN_{op}) - 93,600)^2$$

for $t - t_{op} + 604,800 * (WN - WN_{op}) > 93,600$ seconds

where

t is the GPS system time

The SV shall derive URA_{NED0} , URA_{NED1} , and URA_{NED2} indexes which, when used together in the above equations, results in the minimum $IAURA_{NED}$ that is greater than the predicted $IAURA_{NED}$ during the clock/ephemeris fit interval.

The user shall use the broadcast URA_{NED0} index to derive the URA_{NED0} value. The URA_{NED0} index is a signed, two's complement integer in the range of +15 to -16 and has the following relationship to the URA_{NED0} value:

URA _{NED0} Index		URA _{NED0} (meters)	
15	6144.00	< URA _{NED0}	(or no accuracy prediction is available)
14	3072.00	< URA _{NED0} ≤	6144.00
13	1536.00	< URA _{NED0} ≤	3072.00
12	768.00	< URA _{NED0} ≤	1536.00
11	384.00	< URA _{NED0} ≤	768.00
10	192.00	< URA _{NED0} ≤	384.00

9	96.00	$< URA_{NED0} \leq$	192.00
8	48.00	$< URA_{NED0} \leq$	96.00
7	24.00	$< URA_{NED0} \leq$	48.00
6	13.65	$< URA_{NED0} \leq$	24.00
5	9.65	$< URA_{NED0} \leq$	13.65
4	6.85	$< URA_{NED0} \leq$	9.65
3	4.85	$< URA_{NED0} \leq$	6.85
2	3.40	$< URA_{NED0} \leq$	4.85
1	2.40	$< URA_{NED0} \leq$	3.40
0	1.70	$< URA_{NED0} \leq$	2.40
-1	1.20	$< URA_{NED0} \leq$	1.70
-2	0.85	$< URA_{NED0} \leq$	1.20
-3	0.60	$< URA_{NED0} \leq$	0.85
-4	0.43	$< URA_{NED0} \leq$	0.60
-5	0.30	$< URA_{NED0} \leq$	0.43
-6	0.21	$< URA_{NED0} \leq$	0.30
-7	0.15	$< URA_{NED0} \leq$	0.21
-8	0.11	$< URA_{NED0} \leq$	0.15
-9	0.08	$< URA_{NED0} \leq$	0.11
-10	0.06	$< URA_{NED0} \leq$	0.08
-11	0.04	$< URA_{NED0} \leq$	0.06
-12	0.03	$< URA_{NED0} \leq$	0.04
-13	0.02	$< URA_{NED0} \leq$	0.03
-14	0.01	$< URA_{NED0} \leq$	0.02
-15		$URA_{NED0} \leq$	0.01
-16	No accuracy prediction available-use at own risk		

For each URA_{NED0} index (N), users may compute a nominal URA_{NED0} value (X) as given by:

- If the value of N is 6 or less, but more than -16, $X = 2^{(1 + N/2)}$,
- If the value of N is 6 or more, but less than 15, $X = 2^{(N - 2)}$,

- $N = -16$ or $N = 15$ shall indicate the absence of an accuracy prediction and shall advise the standard positioning service user to use that SV at his own risk.

For $N = 1, 3,$ and 5 , X should be rounded to 2.8, 5.7, and 11.3 meters, respectively.

The nominal URA_{NED0} value (X) shall be suitable for use as a conservative prediction of the RMS NED range errors for accuracy-related purposes in the pseudorange domain (e.g., measurement de-weighting RAIM, FOM computations). Integrity properties of the $IAURA_{NED}$ are specified with respect to the scaled (multiplied by either 4.42 or 5.73 as appropriate) upper bound values of the URA_{NED0} index, URA_{NED1} index, and URA_{NED2} index (see 3.5.3.10.1).

URA_{NED0} accounts for zeroth order SIS contributions to user range error which include, but are not limited to, the following: LSB representation/truncation error; the net effect of clock correction polynomial error and code phase error in the transmitted signal for single-frequency L1C users who correct the code phase as described in Section 3.5.3.9; the net effect of clock parameter, code phase, and inter-signal correction error for dual-frequency L1C/L2C and L1C/L5 users who correct for group delay and ionospheric effects as described in Section 3.5.3.9; radial ephemeris error; anisotropic antenna errors; and signal deformation error. URA_{NED} does not account for user range contributions due to the inaccuracy of the broadcast ionospheric data parameters used in the single-frequency ionospheric model or for other atmospheric effects.

The transmitted URA_{NED1} index is an integer value in the range 0 to 7. The URA_{NED1} index has the following relationship to the URA_{NED1} value:

$$URA_{NED1} = \frac{1}{2^N} \text{ (meters/second)}$$

where

$$N = 14 + URA_{NED1} \text{ Index.}$$

The transmitted URA_{NED2} index is an integer value in the range 0 to 7. URA_{NED2} index has the following relationship to the URA_{NED2} :

$$URA_{NED2} = \frac{1}{2^N} \text{ (meters/second}^2\text{)}$$

where

$$N = 28 + URA_{NED2} \text{ Index.}$$

3.5.3.9 Group Delay Correction Parameters

Bits 527 through 565 of subframe 2 provide the group delay differential correction terms for L1C signal users. The following algorithms shall apply when interpreting the correction parameters in the message. The bit lengths, scale factors, ranges, and units of these parameters are given in Table 3.5-1.

The related algorithm is given in paragraphs 3.5.3.9.1 and 3.5.3.9.2.

The broadcast group delay differential correction terms apply to the pseudorange measurements produced by an ideal correlation receiver with a bandwidth of 20.46 MHz centered at the reference waveform nominal frequency whose phase is linear over that bandwidth using an exact replica of the reference waveform in an early-late discriminator having a correlator spacing of 97.75 nanoseconds. The group delay differential correction terms may not apply to pseudorange measurements produced by different methods due to potential distortion of the transmitted waveform. Users employing pseudorange measurement methods different from the defined method must account for the potential inapplicability of the group delay differential correction terms.

3.5.3.9.1 Inter-Signal Correction

The correction terms, T_{GD} , ISC_{L1CP} , and ISC_{L1CD} , are initially provided by the CS to account for the effect of SV inter-signal biases between L1 P(Y) and L2 P(Y), between L1 P(Y) and L1C_P, and between L1 P(Y) and L1C_D, respectively, based on measurements made by the SV contractor during SV manufacture. The values of T_{GD} and ISCs for each SV may be subsequently updated to reflect the actual on-orbit group delay differential. For maximum accuracy, the single frequency L1C_P user must use the correction terms to make further modifications to the code phase offset in paragraph 20.3.3.3.3.1 of IS-GPS-200 with the equation:

$$(\Delta t_{SV})_{L1CP} = \Delta t_{SV} - T_{GD} + ISC_{L1CP}$$

where T_{GD} (see paragraph 20.3.3.3.3.2 of IS-GPS-200) and ISC_{L1CP} are provided to the user as subframe 2 data.

For maximum accuracy, the single frequency L1C_D user must use the correction terms to make further modifications to the code phase offset given by:

$$(\Delta t_{SV})_{L1CD} = \Delta t_{SV} - T_{GD} + ISC_{L1CD}$$

where, ISC_{L1CD} is provided to the user as subframe 2 data.

The values of ISC_{L1CP} and ISC_{L1CD} are measured values that represent the mean SV group delay differential between the L1 P(Y)-code and the L1C_P-code or L1C_D-code respectively as follows,

$$ISC_{L1CP} = t_{L1P(Y)} - t_{L1CP}$$

$$ISC_{L1CD} = t_{L1P(Y)} - t_{L1CD},$$

where t_{L1x} is the GPS time of the L1 frequency x signal (a specific epoch of the signal) transmitted from the SV antenna phase center.

3.5.3.9.2 L1/L2 Ionospheric Correction

The dual-frequency (L1C_P and L2C) user shall correct for the group delay and ionospheric effects by applying the relationship

$$PR = \frac{(PR_{L2C} - \gamma_{12} PR_{L1CP}) + c(ISC_{L2C} - \gamma_{12} ISC_{L1CP})}{1 - \gamma_{12}} - c T_{GD}$$

The dual-frequency (L1C_D and L2C) user shall correct for the group delay and ionospheric effects by applying the relationship

$$PR = \frac{(PR_{L2C} - \gamma_{12} PR_{L1CD}) + c(ISC_{L2C} - \gamma_{12} ISC_{L1CD})}{1 - \gamma_{12}} - c T_{GD}$$

For the preceding equations, the following definitions apply:

- PR = pseudorange corrected for ionospheric effects,
- PR_i = pseudorange measured on the channel indicated by the subscript,
- ISC_i = inter-signal correction for the channel indicated by the subscript (see paragraph 3.5.3.9.1, see paragraph 30.3.3.3.1.1 of IS-GPS-200 for ISC_{L2C}),
- T_{GD} = see paragraph 20.3.3.3.3.2 of IS-GPS-200,
- c = speed of light,

and, denoting the nominal center frequencies of L1 and L2 as f_{L1} and f_{L2} respectively,

$$\gamma_{12} = (f_{L1}/f_{L2})^2 = (1575.42/1227.6)^2 = (77/60)^2.$$

3.5.3.9.3 L1/L5 Ionospheric Correction

The dual-frequency (L1C_P and L5 Q5) user shall correct for the group delay and ionospheric effects by applying the relationship.

$$PR = \frac{(PR_{L5Q5} - \gamma_{15} PR_{L1CP}) + c(ISC_{L5Q5} - \gamma_{15} ISC_{L1CP})}{1 - \gamma_{15}} - c T_{GD}$$

The dual-frequency (L1C_D and L5 Q5) user shall correct for the group delay and ionospheric effects by applying the relationship.

$$PR = \frac{(PR_{L5Q5} - \gamma_{15} PR_{L1CD}) + c(ISC_{L5Q5} - \gamma_{15} ISC_{L1CD})}{1 - \gamma_{15}} - c T_{GD}$$

The dual-frequency (L1C_P and L5 I5) user shall correct for the group delay and ionospheric effects by applying the relationship.

$$PR = \frac{(PR_{L5I5} - \gamma_{15} PR_{L1CP}) + c(ISC_{L5I5} - \gamma_{15} ISC_{L1CP})}{1 - \gamma_{15}} - c T_{GD}$$

The dual-frequency (L1C_D and L5 I₅) user shall correct for the group delay and ionospheric effects by applying the relationship.

$$PR = \frac{(PR_{L5I5} - \gamma_{15} PR_{L1CD}) + c(ISC_{L5I5} - \gamma_{15} ISC_{L1CD})}{1 - \gamma_{15}} - cT_{GD}$$

For the preceding equations, the following definitions apply:

PR = pseudorange corrected for ionospheric effects,

PR_i = pseudorange measured on the channel indicated by the subscript,

ISC_i = inter-signal correction for the channel indicated by the subscript (see paragraph 3.5.3.9.1,

see paragraph 20.3.3.3.1.2.1 of IS-GPS-705 for ISC_{L5Q5} and ISC_{L5I5}),

T_{GD} = see paragraph 20.3.3.3.3.2 of IS-GPS-200,

c = speed of light,

and, denoting the nominal center frequencies of L1 and L5 as f_{L1} and f_{L5} respectively,

$$\gamma_{15} = (f_{L1}/f_{L5})^2 = (1575.42/1176.45)^2 = (154/115)^2.$$

3.5.3.10 Integrity Assurance

The L1C message will contain information that allows users to operate when integrity is assured. This is accomplished using an integrity assured URA value in conjunction with an integrity status flag. The URA value is the RSS of URA_{ED} and URA_{NED}; URA is integrity assured to the enhanced level only when the integrity status flag is “1”.

3.5.3.10.1 Integrity Status Flag (ISF)

Bit 566 of subframe 2 shall be the Integrity Status Flag (ISF). A “0” in bit position 566 indicates that the conveying signal is provided with the legacy level of integrity assurance. That is, the probability that the instantaneous URE of the conveying signal exceeds 4.42 times the upper bound value of the current broadcast URA index, for more than 5.2 seconds, without an accompanying alert, is less than 1 x 10⁻⁵ per hour. A “1” in bit position 566 indicates that the conveying signal is provided with an enhanced level of integrity assurance.

That is, the probability that the instantaneous URE of the conveying signal exceeds 5.73 times the upper bound value of the current broadcast URA index, for more than 5.2 seconds, without an accompanying alert, is less than 1 x 10⁻⁸ per hour. The probabilities associated with the nominal and lower bound values of the current broadcast URA are not defined.

In this context, an “alert” is defined as any indication or characteristic in the conveying signal, as specified elsewhere in this document, which signifies that the conveying signal may be invalid and should not be used, such as, not Operational-Healthy, Non-Standard Code, parity error, etc.

3.5.3.11 CEI Data Sequence Propagation Week Number.

Bits 567-574 of subframe 2 shall indicate the CEI Data Sequence Propagation Week Number (WN_{op}) to which the CEI Data Sequence Propagation Time of Week (t_{op}) is referenced (see 3.5.3.3). The WN_{op} term consists of eight bits which shall be a modulo 256 binary representation of the GPS week number to which the t_{op} is referenced. The combination of the epoch time of state data (t_{op} , WN_{op}) for a valid CEI data sequence propagation will be in the past relative to the time of broadcast.

3.5.4 Subframe 3

Subframe 3 provides users with other navigation data which is commutated over multiple pages. The contents of subframe 3 data are defined below.

Every subframe 3 page begins with an 8-bit PRN number of the transmitting SV with a range of 0 (00000000) to 255 (11111111). Each subframe 3 page is identified by a 6-bit page number provided in bits 9 through 14.

3.5.4.1 Subframe 3, Page 1 - UTC & IONO

As depicted in Figure 3.5-2, subframe 3, page 1 contains the UTC and ionospheric correction parameters. The contents of subframe 3, page 1, are defined below, and followed by material pertinent to the use of the data.

3.5.4.1.1 UTC Parameter Content

Subframe 3, page 1 shall contain the parameters related to correlating UTC (USNO) time with GPS Time. The bit lengths, scale factors, ranges, and units of these parameters are given in Table 3.5-3. See Figure 3.5-2 for complete bit allocation in subframe 3, page 1.

The parameters relating GPS time to UTC (USNO) shall be updated by the CS at least once every three days while the CS is able to upload the SVs. If the CS is unable to upload the SVs, the accuracy of the UTC parameters transmitted by the SVs will degrade over time.

3.5.4.1.1.1 UTC and GPS Time

Subframe 3, page 1 includes: (1) the parameters needed to relate GPS Time to UTC (USNO), and (2) notice to the user regarding the scheduled future or recent past (relative to navigation message upload) value of the delta time due to leap seconds (Δt_{LSF}), together with the GPS week number (WN_{LSF}) and the GPS day number (DN) near the end of which Δt_{LSF} becomes effective. Information required to use these parameters to calculate t_{UTC} is in paragraph 20.3.3.5.2.4 of IS-GPS-200 except the following definition of Δt_{UTC} shall be used:

$$\Delta t_{UTC} = \Delta t_{LS} + A_{0-n} + A_{1-n} (t_E - t_{ot} + 604800 (WN - WN_{ot})) + A_{2-n} (t_E - t_{ot} + 604800 (WN - WN_{ot}))^2$$

seconds.

Table 3.5-3. UTC Parameters

Parameter		No. of Bits**	Scale Factor (LSB)	Valid Range***	Units
A_{0-n}	Bias coefficient of GPS time scale relative to UTC time scale	16*	2^{-35}		seconds
A_{1-n}	Drift coefficient of GPS time scale relative to UTC time scale	13*	2^{-51}		sec/sec
A_{2-n}	Drift rate correction coefficient of GPS time scale relative to UTC time scale	7*	2^{-68}		sec/sec ²
Δt_{LS}	Current or past leap second count	8*	1		seconds
t_{ot}	Time data reference Time of Week	16	2^4	0 to 604,784	seconds
WN_{ot}	Time data reference Week Number	13	1		weeks
WN_{LSF}	Leap second reference Week Number	13	1		weeks
DN	Leap second reference Day Number	4	1	1 to 7	days
Δt_{LSF}	Current or future leap second count	8*	1		seconds
<p>* Parameters so indicated shall be in two's complement notation;</p> <p>** See Figure 3.5-2 for complete bit allocation;</p> <p>*** Unless otherwise indicated in this column, valid range is the maximum range attainable with indicated bit allocation and scale factor;</p>					

3.5.4.1.2 Ionospheric Data

The ionospheric parameters which allow the “L1 only” user to utilize the ionospheric model for computation of the ionospheric delay are contained in subframe 3, page 1. The “single-frequency” user should use the model given in paragraph 20.3.3.5.2.5 of IS-GPS-200 to make this correction for the ionospheric effects. The bit lengths, scale factors, ranges, and units of these parameters are given in Table 20-X of IS-GPS-200.

The ionospheric data shall be updated by the CS at least once every six days while the CS is able to upload the SVs. If the CS is unable to upload the SVs, the ionospheric data transmitted by the SVs may not be accurate.

3.5.4.2 Subframe 3, Page 2 - GGTO & EOP

Subframe 3, page 2, as depicted in Figure 3.5-3, contains the GPS/Global Navigation Satellite System (GNSS) Time Offset (GGTO) parameters and Earth Orientation Parameters (EOP). The contents of subframe 3, page 2, is defined below, and followed by material pertinent to the use of the data.

3.5.4.2.1 GGTO Parameter Content

Subframe 3, page 2 shall contain the parameters related to correlating GPS time with other GNSS time. Bits 15 through 17 of subframe 3, page 2 shall identify the other GPS-like navigation system to which the offset data applies. The three bits are defined as follows:

000 = no data available,

001 = Galileo,

010 = GLONASS,

011 through 111 = Reserved in order to preserve the use of these values in a future version of this IS. Until such a revision, a developer developing to this version of this IS should interpret these values as indicating that the GPS/GNSS Time Offset Parameter data, to which the GNSS Type ID applies, is presently unusable.

The bit lengths, scale factors, ranges, and units of the GGTO parameters are given in Table 3.5-4. See Figure 3.5-3 for complete bit allocation in subframe 3, page 2.

The validity period of the GGTO shall be 1 day as a minimum.

3.5.4.2.1.1 GPS and GNSS Time

The GPS/GNSS-time relationship is given by,

$$t_{\text{GNSS}} = t_E - (A_{0\text{GGTO}} + A_{1\text{GGTO}} (t_E - t_{\text{GGTO}} + 604,800 (W_N - W_{\text{N}_{\text{GGTO}}})) + A_{2\text{GGTO}} (t_E - t_{\text{GGTO}} + 604,800 (W_N - W_{\text{N}_{\text{GGTO}}}))^2)$$

where t_{GNSS} is in seconds, t_E and W_N are as defined in Section 20.3.3.5.2.4 of IS-GPS-200, and the remaining parameters are as defined in Table 3.5-4

The GGTO parameters provide a global average of the time offset between GPS time and the other GNSS time scales modulo one second. Users must also apply any integer seconds difference between the systems using definitions of each system time scale as defined in respective signal interface documents.

Table 3.5-4. GPS/GNSS Time Offset Parameters

Parameter		No. of Bits**	Scale Factor (LSB)	Valid Range***	Units
A _{0GGTO}	Bias coefficient of GPS time scale relative to GNSS time scale	16*	2 ⁻³⁵		seconds
A _{1GGTO}	Drift coefficient of GPS time scale relative to GNSS time scale	13*	2 ⁻⁵¹		sec/sec
A _{2GGTO}	Drift rate correction coefficient of GPS time scale relative to GNSS time scale	7*	2 ⁻⁶⁸		sec/sec ²
t _{GGTO}	Time data reference Time of Week	16	2 ⁴	0 to 604,784	seconds
WN _{GGTO}	Time data reference Week Number	13	2 ⁰		weeks
GNSS ID	GNSS Type ID	3			see text

* Parameters so indicated shall be in two's complement notation;
 ** See Figure 3.5-3 for complete bit allocation;
 *** Unless otherwise indicated in this column, valid range is the maximum range attainable with indicated bit allocation and scale factor.

3.5.4.2.2 EOP Content

Subframe 3, page 2 shall contain earth orientation parameters. The EOP message provides users with parameters to construct the ECEF and ECI coordinate transformation (a simple transformation method that does not account for EOP, is defined in Section 20.3.3.4.3.3.2 of IS-GPS-200). The bit lengths, scale factors, ranges, and units of all EOP fields of subframe 3, page 2, are given in Table 3.5-5.

3.5.4.2.3 User Algorithm for Application of the EOP

The EOP fields in subframe 3, page 2 contain the EOP needed to construct the ECEF-to-ECI coordinate transformation. The user computes the ECEF position of the SV antenna phase center using the equations shown in Table 3.5-2. The coordinate transformation, for translating to the corresponding ECI SV antenna phase center position, is derived using the equations shown in IERS Technical Note 36 and Table 30-VIII of IS-GPS-200 in accordance with Section 30.3.3.5.1.1 of IS-GPS-200. The coordinate systems are defined in Section 20.3.3.4.3.3 of IS-GPS-200.

EOPs that are not updated by the CS will degrade in accuracy over time.

When calculating $UT1$, x_p , and y_p in Table 30-VIII of IS-GPS-200, the week number for t_{EOP} is equal to the WN_{ot} value in subframe 3 page 2 when both criteria are met:

- t_{EOP} in subframe 3 page 1 is equal to t_{ot} in subframe 3 page 2
- Subframe 3 page 1 and subframe 3 page 2 were transmitted within a continuous 4-hour period

If both criteria are not met, the data between the two pages may be inconsistent with each other and should not be used for the calculations in Table 30-VIII of IS-GPS-200.

Table 3.5-5. Earth Orientation Parameters

Parameter		No. of Bits**	Scale Factor (LSB)	Valid Range***	Units
t_{EOP}	EOP Data Reference Time	16	2^4	0 to 604,784	seconds
PM_X †, ††††	X-Axis Polar Motion Value at Reference Time.	21*	2^{-20}		arc-seconds
PM_X ††††	X-Axis Polar Motion Drift at Reference Time.	15*	2^{-21}		arc-seconds/day
PM_Y ††, ††††	Y-Axis Polar Motion Value at Reference Time.	21*	2^{-20}		arc-seconds
PM_Y ††††	Y-Axis Polar Motion Drift at Reference Time.	15*	2^{-21}		arc-seconds/day
$\Delta UTGPS$ †††	UT1-GPS Difference at Reference Time.	31*	2^{-23}		seconds
$\Delta UTGPS$ †††	Rate of UT1-GPS Difference at Reference Time.	19*	2^{-25}		seconds/day
<p>* Parameters so indicated are in two's complement notation;</p> <p>** See Figure 3.5-3 for complete bit allocation in subframe 3, page 2;</p> <p>*** Unless otherwise indicated in this column, valid range is the maximum range attainable with indicated bit allocation and scale factor.</p> <p>† Represents the predicted angular displacement of instantaneous Celestial Intermediate Pole with respect to semi-minor axis of the reference ellipsoid along Greenwich meridian.</p> <p>†† Represents the predicted angular displacement of instantaneous Celestial Intermediate Pole with respect to semi-minor axis of the reference ellipsoid on a line directed 90° west of Greenwich meridian.</p> <p>††† Already account for zonal, diurnal, and semi-diurnal tides and should not be further applied by the user.</p> <p>†††† Already account for diurnal and semi-diurnal tides and should not be further applied by the user.</p>					

3.5.4.3 Subframe 3, Page 3 & Page 4 - Almanac

The almanac parameters are provided in any one of subframe 3, pages 3 and 4. Page 3 provides the reduced almanac parameters and Midi almanac parameters are provided in page 4. The reduced almanac parameters (i.e. subframe 3, page 3) for the complete set of SVs in the constellation will be broadcast by a SV using shorter duration of time compared to the broadcast of the complete set of Midi almanac parameters (i.e. subframe 3, page 4). The parameters are defined below, followed by material pertinent to the use of the data.

3.5.4.3.1 Almanac Reference Week

Bits 15 through 27 of subframe 3, pages 3 and 4 shall indicate the number of the week (WN_{a-n}) to which the almanac reference time (t_{oa}) is referenced (see paragraph 3.5.4.3.2).

The WN_{a-n} term consists of 13 bits which shall be a modulo-8192 binary representation of the GPS week number (see paragraph 6.2.2) to which the t_{oa} is referenced.

Bits 28 through 35 of subframe 3, pages 3 and 4 shall contain the value of t_{oa} , which is referenced to this WN_{a-n} .

3.5.4.3.2 Almanac Reference Time

See paragraph 20.3.3.5.2.2 of IS-GPS-200.

3.5.4.3.3 SV PRN Number

Bits 36 through 43 of subframe 3, page 4 and bits 1 through 8 in each packet of reduced almanac shall specify PRN number of the SV whose almanac or reduced almanac, respectively, is provided in the message or in the packet.

3.5.4.3.4 Signal Health (L1/L2/L5)

The three, one-bit, health indication in bits 44, 45 and 46 of subframe 3, page 4 and bits 31, 32 and 33 of each packet of reduced almanac refers to the L1, L2, and L5 carrier of the SV whose PRN number is specified in the message or in the packet. These health indication bits only apply to codes and data as defined in IS-GPS-200, IS-GPS-705, and IS-GPS-800.

The health of each carrier is indicated by:

0 = Some or all codes and data on this carrier are OK,

1 = All codes and data on this carrier are bad or unavailable.

The health bit indication shall be given relative to the capabilities of each SV as designated by the configuration code in the LNAV message (see paragraph 20.3.3.5.1.4 of IS-GPS-200) or the CNAV-2 message (see paragraph 3.5.4.7). Accordingly, the health bit for any SV which does not have a certain capability will be indicated as "healthy" if the lack of this capability is inherent in its design or if it has been configured into a mode which is normal from a user standpoint and does not require that capability; however, the Operating Command may choose to set the health bit "unhealthy" for an SV without a certain capability. Users who have not received or choose not to use configuration code should assume that every signal is available on every SV. The predicted health data will be updated at the time of upload when a new CEI data set has been built by the CS. Therefore, the transmitted health data may not correspond to the actual health of the transmitting SV. For more information about user protocol for interpreting health indications see paragraph 6.4.5.

3.5.4.3.5 Reduced Almanac Data

Subframe 3, page 3, Figure 3.5-4, shall contain reduced almanac data packets for 6 SVs. The reduced almanac data of a SV is broadcast in a packet of 33 bits long, as described in Figure 3.5-9. The reduced almanac data are a subset of the almanac data which provide an ephemeris with less precision than that derived from parameters in subframe 2. The reduced almanac data values are provided relative to pre-specified reference values. The bit lengths, scale factors, ranges, and units of the reduced almanac parameters are given in Table 3.5-6.

The reduced almanac parameters shall be updated by the CS at least once every 3 days while the CS is able to upload the SVs. If the CS is unable to upload the SVs then the accuracy of the reduced almanac parameters transmitted by the SVs will degrade over time.

3.5.4.3.5.1 Reduced Almanac Packet

The following shall apply when interpreting the data provided in each packet of reduced almanac (see Figure 3.5-9).

3.5.4.3.5.1.1 Reduced Almanac

The reduced almanac data is provided in bits 9 through 30 of each packet. The data from a packet along with the reference values (see Table 3.5-6) provide ephemeris with further reduced precision. The user algorithm is essentially the same as the user algorithm employed for computing the ephemeris from the parameters in subframe 2 (see Section 3.5.3.6.1 and Table 3.5-2). Other parameters appearing in the equations of Table 3.5-2, but not provided by the reduced almanac with the reference values, are set to zero for SV position determination.

An 8-bit value of “00000000” in the PRN_a field shall indicate that there is no data in the reduced almanac packet. In this event, all subsequent bits through the last bit of the last packet in the message (bit 233) shall be filler bits, i.e., alternating ones and zeros beginning with one.

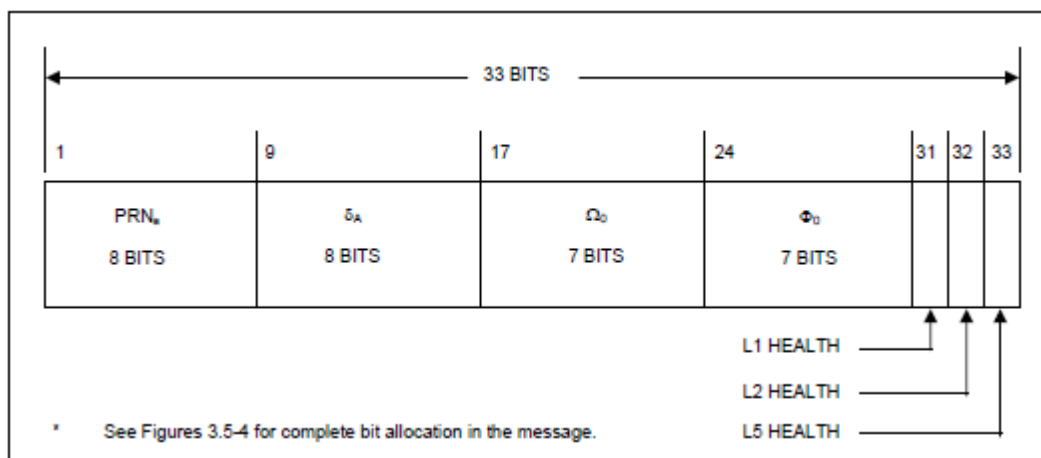

Figure 3.5-9. Reduced Almanac Packet Content

Table 3.5-6. Reduced Almanac Parameters*****

Parameter	No. of Bits	Scale Factor (LSB)	Valid Range **	Units
δ_A ***	8 *	2^{+9}	**	Meters
Ω_0	7 *	2^{-6}	**	semi-circles
Φ_0 *****	7 *	2^{-6}	**	semi-circles

* Parameters so indicated shall be in two's complement notation;
 ** Valid range is the maximum range attainable with indicated bit allocation and scale factor;
 *** Relative to $A_{ref} = 26,559,710$ meters;
 ***** $\Phi_0 = \text{Argument of Latitude at Reference Time} = M_0 + \omega$;
 ***** Relative to following reference values:
 $e = 0$
 $\delta_i = +0.0056$ semi-circles ($i = 55$ degrees)
 $\dot{\Omega} = -2.6 \times 10^{-9}$ semi-circles/second

3.5.4.3.6 Midi Almanac Parameter Content

Subframe 3, page 4 shall contain Midi almanac data for a SV whose PRN number is specified in the message. The bit lengths, scale factors, ranges, and units of the almanac parameters are given in Table 3.5-7. The user algorithm is essentially the same as the user algorithm employed for computing the ephemeris as specified in Table 20-IV of IS-GPS-200. Other parameters appearing in the equations of Table 20-IV of IS-GPS-200, but not provided by the Midi almanac with the reference values, are set to zero for SV position determination. See paragraph 20.3.3.5.2.3 of IS-GPS-200 for almanac time parameters.

Table 3.5-7. Midi Almanac Parameters

Parameter	No. of Bits**	Scale Factor (LSB)	Valid Range***	Units
t_{oa}	8	2^{12}	0 to 602,112	seconds
e	11	2^{-16}	0.0 to 0.03	dimensionless
δ_i^{****}	11*	2^{-14}		semi-circles
$\dot{\Omega}$	11*	2^{-33}	-1.19E-07 to 0	semi-circles/sec
\sqrt{A}	17	2^{-4}	2530 to 8192	$\sqrt{\text{meters}}$
Ω_0	16*	2^{-15}		semi-circles
ω	16*	2^{-15}		semi-circles
M_0	16*	2^{-15}		semi-circles
a_{f0}	11*	2^{-20}		seconds
a_{f1}	10*	2^{-37}		sec/sec

* Parameters so indicated shall be in two's complement notation;

** See Figure 3.5-5 for complete bit allocation in subframe 3, page 4;

*** Unless otherwise indicated in this column, valid range is the maximum range attainable with indicated bit allocation and scale factor;

**** Relative to $i_0 = 0.30$ semi-circles.

3.5.4.4 Subframe 3, Page 5 - Differential Correction

Subframe 3, page 5, Figure 3.5-6, contains the Differential Correction (DC) parameters. These parameters provide users with sets of correction terms that apply to the clock and ephemeris data transmitted by *other* SVs. DC parameters are grouped in packets, as described in this section. The availability of this data is subject to the control and determination of the CS. The contents of subframe 3, page 5, are defined below, and followed by material pertinent to the use of the data.

3.5.4.4.1 Differential Correction Parameter Content

Subframe 3, page 5 shall contain DC parameters that apply to the clock and ephemeris data transmitted by another SV.

One subframe 3, page 5, as depicted in Figure 3.5-6, shall contain 34 bits of clock differential correction (CDC) parameters and 92 bits of ephemeris differential correction (EDC) parameters for one SV other than the transmitting SV.

Bit 37 of subframe 3, page 5 shall be a DC Data Type indicator that indicates the data type for which the DC parameters apply. Zero (0) signifies that the corrections apply to CNAV-2 data, $D_{LIC}(t)$, and one (1) signifies that the corrections apply to legacy navigation (LNAV) data, $D(t)$, defined in Appendix II of IS-GPS-200.

The content of an individual data packet is depicted in Figure 3.5-10. The bit lengths, scale factors, ranges, and units of all fields in the DC packet are given in Table 3.5-8.

3.5.4.4.2 Differential Correction Data Predict Time of Week

The DC data predict time of week (t_{op-D}) provides the epoch time of week, in increments of 300 seconds (i.e. five minutes), at which the prediction for the associated DC data was performed.

3.5.4.4.3 Time of Differential Correction Data

The time of DC data, t_{OD} , specifies the reference time of week, in increments of 300 seconds (i.e., five minutes) relative to the GPS week, for the associated CDC and EDC data.

3.5.4.4.4 DC Data Packet

Each DC data packet contains: corrections to SV clock polynomial coefficients provided in subframe 2 of the corresponding SV; corrections to quasi-Keplerian elements referenced to t_{OD} of the corresponding SV; and User Differential Range Accuracy (UDRA) and UDRA indices that enable users to estimate the accuracy obtained after corrections are applied. Each DC packet is made up of two different segments. The first segment contains 34 bits for the CDC parameters and the second segment contains 92 bits of EDC parameters totaling 126 bits. The CDC and EDC parameters form an indivisible pair and users must utilize CDC and EDC as a pair.

3.5.4.4.1 SV PRN Identification

The PRN ID of both CDC and EDC as depicted in Figure 3.5-10 identifies the satellite to which the subject 126-bit differential correction packet data applies (by PRN code assignment). A value of all ones “11111111” in any PRN ID field shall indicate that no DC data is contained in the remainder of the data block.

In this event, the remainder of the data block shall be filler bits, i.e., alternating ones and zeros beginning with one.

3.5.4.4.2 Application of DC Data

The application of CDC data and EDC data is defined in paragraphs 30.3.3.7.3, 30.3.3.7.4, and 30.3.3.7.5 of IS-GPS-200.

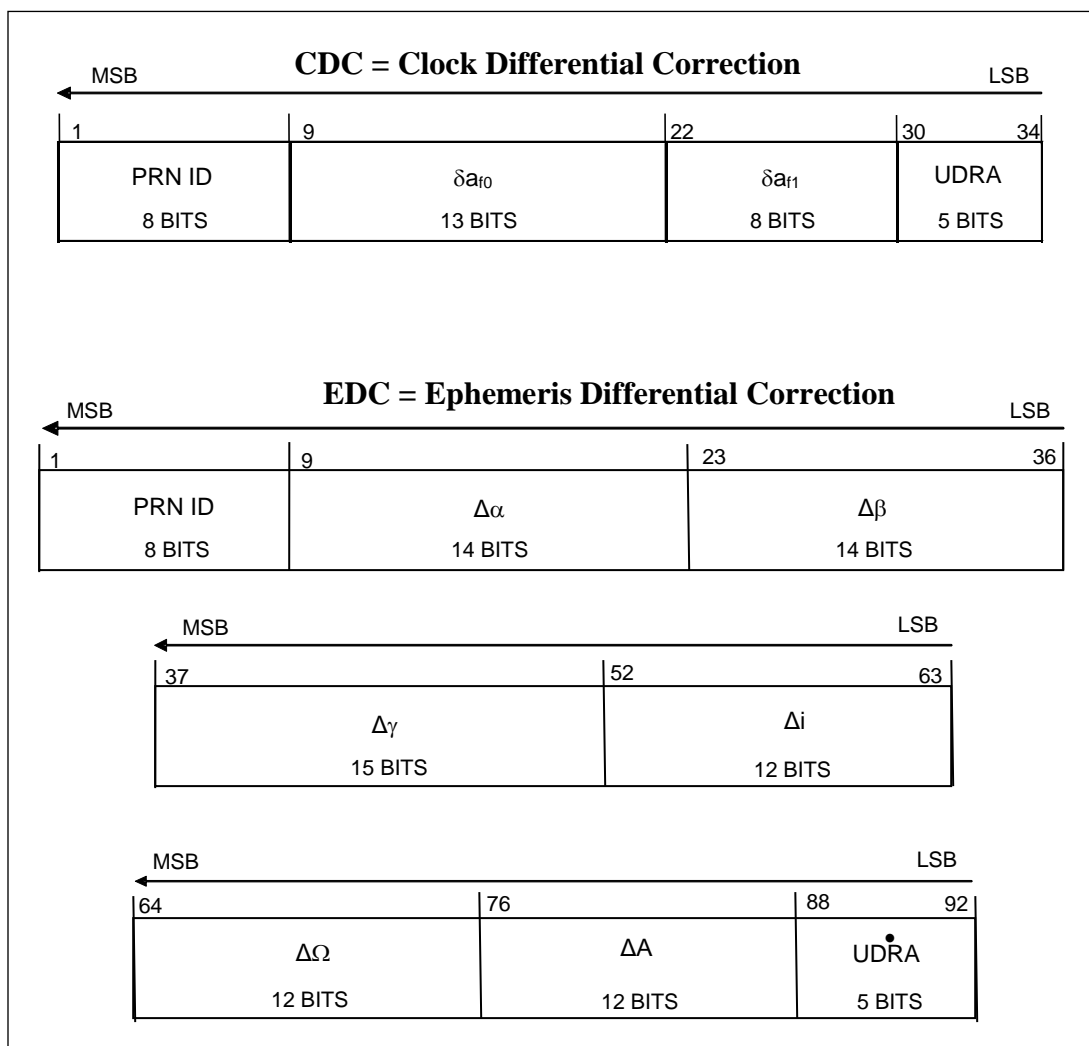

Figure 3.5-10. Differential Correction Data Packet

Table 3.5-8. Differential Correction Parameters

Parameter		No. of Bits**	Scale Factor (LSB)	Valid Range***	Units
PRN ID		8			see text
t_{op-D}	DC Data Predict Time of Week	11	300	0 to 604,500	seconds
t_{OD}	Time of DC Data	11	300	0 to 604,500	seconds
δa_{f0}	SV Clock Bias Correction	13*	2^{-35}		seconds
δa_{f1}	SV Clock Drift Correction	8*	2^{-51}		seconds/second
UDRA	User Differential Range Accuracy Index	5*			see text
$\Delta\alpha$	Alpha Correction to Ephemeris Parameters	14*	2^{-34}		dimensionless
$\Delta\beta$	Beta Correction to Ephemeris Parameters	14*	2^{-34}		dimensionless
$\Delta\gamma$	Gamma Correction to Ephemeris Parameters	15*	2^{-32}		semi-circles
Δi	Angle of Inclination Correction	12*	2^{-32}		semi-circles
$\Delta\Omega$	Angle of Right Ascension Correction	12*	2^{-32}		semi-circles
ΔA	Semi-Major Correction	12*	2^{-9}		meters
\dot{UDRA}	Change Rate of User Differential Range Accuracy Index.	5*			see text
<p>* Parameters so indicated are in two's complement notation; ** See Figure 3.5-6 for complete bit allocation in subframe 3, page 5; *** Unless otherwise indicated in this column, valid range is the maximum range attainable with indicated bit allocation and scale factor.</p>					

3.5.4.5 Subframe 3, Page 6 - Text

Subframe 3, page 6, as depicted in Figure 3.5-7, contains the Text message. The specific contents of text message will be at the discretion of the Operating Command. Subframe 3, page 6 can accommodate the transmission of 29 eight-bit American Standard Code for Information Interchange (ASCII) characters. The requisite bits shall occupy bits 19 through 250 of subframe 3, page 6.

The eight-bit ASCII characters shall be limited to the set described in paragraph 20.3.3.5.1.8 of IS-GPS-200.

3.5.4.6 Subframe 3, Page 7 - SV Configuration

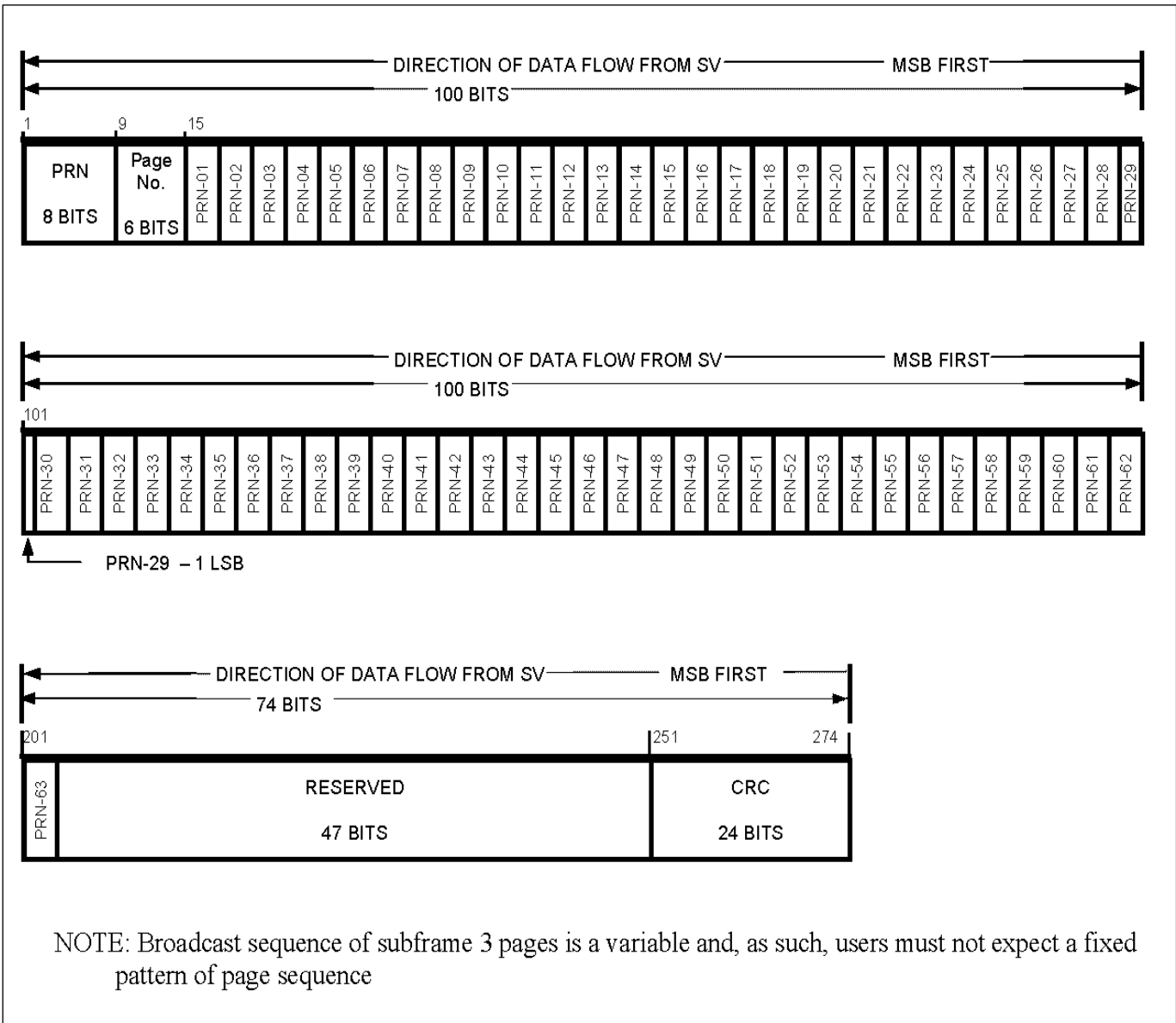

NOTE: Broadcast sequence of subframe 3 pages is a variable and, as such, users must not expect a fixed pattern of page sequence

Figure 3.5-11. Subframe 3, Page 7 - SV Configuration

Subframe 3, page 7, as depicted in Figure 3.5-11, contains a three-bit long term for each of up to 63 SVs to indicate the configuration code of each SV.

The 63 three-bit-long terms shall indicate the configuration of each SV using the codes as defined in paragraph 20.3.3.5.1.4 of IS-GPS-200.

3.5.4.7 Subframe 3, Page 8- Integrity Support Message (ISM)

Figure 3.5-8a contains the structure of the Subframe 3, Page 8 message. The contents are defined below, followed by material pertinent to the use of the Integrity Support Message (ISM) data. Users who implement Advanced Receiver Autonomous Integrity Monitoring (ARAIM) may use these parameters for the ARAIM algorithm as referenced in future TSO and MSO.

3.5.4.7.1 ISM Parameter Content

Subframe 3, Page 8 shall contain the parameters related to GNSS constellation and satellite integrity parameters used for ARAIM algorithms.

The bit lengths, scale factors, ranges, and units of these parameters are given in Table 3.5-9.

The CS shall upload the current ISM parameters, when necessary, to the SVs.

Users should use the ISM parameters with the most recent WN_{ISM} and TOW_{ISM} time stamp. All time stamps should be in the past.

Table 3.5-9 ISM Parameters

Parameter	No. of Bits**	Scale Factor (LSB)	Valid Range***	Units
GNSS ID	4			
WN_{ISM}	13	1		weeks
TOW_{ISM}	6	4	0 to 164	hours
t_{correl}	4		0 to 12	hours
b_{nom}	4		0 to 2	meters
γ_{nom}	4		0 to 2	
R_{sat}	4		1×10^{-3} to 3.16×10^{-10}	/hours
P_{const}	4		1×10^{-3} to 3.16×10^{-10}	
MFD	4		0.25 to 24	hours
Service Level*	3			
Mask ****	63			

* See Table 3.5-10 for Service Level Descriptions
 ** See Figure 3.5-8a for complete bit allocation in Subframe 3, Page 8
 *** Unless otherwise indicated in this column, valid range is the maximum range attainable with indicated bit allocation and scale factor
 **** See Table 3.5-11 for Mask bit mapping

3.5.4.7.1.1 GNSS Constellation ID

Bits 15 through 18 of Subframe 3, Page 8 shall identify the GNSS service to which the associated ISM parameters apply.

The four bits are defined as follows:

0000 = No Data Available

0001 = Galileo

0010 = GLONASS

0011 = BeiDou

0100 = GPS

0101 = SBAS

0110 = QZSS

0111 = IRNSS

1000 through 1111 = Reserved for other systems

If users see four bits of '0000', users will ignore the entire ISM.

3.5.4.7.1.2 ISM Effectivity Time Stamp Week Number

Bits 19 through 31 of Subframe 3, Page 8 shall provide the ISM Week Number (WN_{ISM}) applicable to the start of the time of validity for a given ISM data issue.

This parameter describes the time stamp, in terms of weeks, for the ISM parameters.

3.5.4.7.1.3 ISM Effectivity Time Stamp Time of Week

Bits 32 through 37 of Subframe 3, Page 8 shall provide the ISM time of week (TOW_{ISM}) applicable to the start of the time of validity for a given ISM data issue.

This parameter describes the time stamp, in terms of hours, for the ISM parameters.

3.5.4.7.1.4 Correlation Time Constant

Bits 38 through 41 of Subframe 3, Page 8 shall provide the assumed Correlation Time Constant (t_{correl}) value for the ARAIM at the current time for the associated GNSS constellation.

The four bits are defined as follows:

0000 = 0.25 hours

0001 = 0.33 hours

0010 = 0.50 hours

0011 = 0.67 hours

0100 = 0.83 hours

0101 = 1.00 hour

0110 = 1.17 hours

0111 = 1.33 hours

1000 = 1.50 hours

1001 = 2.10 hours

1010 = 3.00 hours

1011 = 4.20 hours

1100 = 6.00 hours

1101 = 8.50 hours

1110 = 12.00 hours

1111 = RESERVED

3.5.4.7.1.5 Additive Term for Nominal Pseudorange Error Bias

Bits 42 through 45 of Subframe 3, Page 8 shall provide the assumed Additive Term (b_{nom}) for ARAIM at the current time for the associated GNSS constellation.

The four bits are defined as follows:

0000 = 0.00 meters

0001 = 0.13 meters

0010 = 0.25 meters

0011 = 0.38 meters

0100 = 0.50 meters

0101 = 0.63 meters

0110 = 0.75 meters

0111 = 0.88 meters

1000 = 1.00 meter

1001 = 1.13 meters

1010 = 1.25 meters

1011 = 1.38 meters

1100 = 1.50 meters

1101 = 1.63 meters

1110 = 1.75 meters

1111 = 2.00 meters

3.5.4.7.1.6 Scalar Term for Nominal Pseudorange Error Bias

Bits 46 through 49 of Subframe 3, Page 8 shall provide the assumed Scalar Term (γ_{nom}) value for ARAIM at the current time for the associated GNSS constellation.

The four bits are defined as follows:

$$0000 = 0.00$$

$$0001 = 0.13$$

$$0010 = 0.25$$

$$0011 = 0.38$$

$$0100 = 0.50$$

$$0101 = 0.63$$

$$0110 = 0.75$$

$$0111 = 0.88$$

$$1000 = 1.00$$

$$1001 = 1.13$$

$$1010 = 1.25$$

$$1011 = 1.38$$

$$1100 = 1.50$$

$$1101 = 1.63$$

$$1110 = 1.75$$

$$1111 = 2.00$$

3.5.4.7.1.7 Satellite Fault Probability

Bits 50 through 53 of Subframe 3, Page 8 shall provide the assumed Satellite Fault Probability (R_{sat}) value for ARAIM at the current time for the associated GNSS constellation.

The four bits are defined as follows:

$$0000 = 3.16 \times 10^{-3} \text{ /hours}$$

$$0001 = 1 \times 10^{-3} \text{ /hours}$$

$$0010 = 3.16 \times 10^{-4} \text{ /hours}$$

$$0011 = 1 \times 10^{-4} \text{ /hours}$$

$$0100 = 3.16 \times 10^{-5} \text{ /hours}$$

$$0101 = 1 \times 10^{-5} \text{ /hours}$$

$$0110 = 3.16 \times 10^{-6} \text{ /hours}$$

$$0111 = 1 \times 10^{-6} \text{ /hours}$$

$$1000 = 3.16 \times 10^{-7} \text{ /hours}$$

$$1001 = 1 \times 10^{-7} \text{ /hours}$$

$$1010 = 3.16 \times 10^{-8} \text{ /hours}$$

$$1011 = 1 \times 10^{-8} \text{ /hours}$$

$$1100 = 3.16 \times 10^{-9} \text{ /hours}$$

$$1101 = 1 \times 10^{-9} \text{ /hours}$$

$$1110 = 3.16 \times 10^{-10} \text{ /hours}$$

$$1111 = \text{RESERVED}$$

3.5.4.7.1.8 Constellation Fault Probability

Bits 54 through 57 of Subframe 3, Page 8 shall provide the assumed Constellation Fault Probability (P_{const}) value for the ARAIM at the current time for the associated GNSS constellation.

The four bits are defined as follows:

$$0000 = 3.16 \times 10^{-3}$$

$$0001 = 1 \times 10^{-3}$$

$$0010 = 3.16 \times 10^{-4}$$

$$0011 = 1 \times 10^{-4}$$

$$0100 = 3.16 \times 10^{-5}$$

$$0101 = 1 \times 10^{-5}$$

$$0110 = 3.16 \times 10^{-6}$$

$$0111 = 1 \times 10^{-6}$$

$$1000 = 3.16 \times 10^{-7}$$

$$1001 = 1 \times 10^{-7}$$

$$1010 = 3.16 \times 10^{-8}$$

$$1011 = 1 \times 10^{-8}$$

$$1100 = 3.16 \times 10^{-9}$$

$$1101 = 1 \times 10^{-9}$$

$$1110 = 3.16 \times 10^{-10}$$

$$1111 = \text{RESERVED}$$

3.5.4.7.1.9 Mean Fault Duration

Bits 58 through 61 of Subframe 3, Page 8 shall provide the assumed Mean Fault Duration (MFD) value for the ARAIM at the current time for the associated GNSS constellation.

The four bits are defined as follows:

0000 = 0.25 hours

0001 = 0.33 hours

0010 = 0.50 hours

0011 = 0.67 hours

0100 = 0.83 hours

0101 = 1 hour

0110 = 1.25 hours

0111 = 1.50 hours

1000 = 1.75 hours

1001 = 2 hours

1010 = 3 hours

1011 = 4 hours

1100 = 7 hours

1101 = 10 hours

1110 = 17 hours

1111 = 24 hours

3.5.4.7.1.10 Service Level

Bits 62 through 64 of Subframe 3, Page 8 shall provide the Service Level, as described in Table 3.5-10, applicable to a given page of the ISM data issue.

Three bits are allocated to the four identified service levels as follows:

000 = Level 1

001 = Level 2

010 = Level 3

011 = Level 4

100 to 111 = Reserved for future use

Table 3.5-10 Service Level

Service Level	Severity	Description
Level 1	No Data Available	Service Level indicates that users may resort to the Performance Values for integrity solutions instead of this ISM. Users should not use this ISM
Level 2	Non-Safety of Life Use	Service Level indicates that users may only use these parameters for non-safety of life (i.e., uncertified ARAIM) applications.
Level 3	Safety of Life Use (Horizontal)	Service Level indicates that the user should only use these parameters for the applications requiring integrity less than or equivalent to H-ARAIM solutions.
Level 4	Safety of Life Use (Vertical)	Service Level indicates that the user should only use these parameters for the applications requiring integrity less than or equivalent to V-ARAIM solutions.

3.5.4.7.1.11 Satellite Mask

Bits 65 through 127 of Subframe 3, Page 8 shall provide the PRN inclusion mask. Refer to Table 3.5-11 for complete GNSS PRN mapping.

The applicability of each PRN is indicated by:

0 = Information in the current ISM does not apply to this PRN

1 = Information in the current ISM does apply to this PRN

Table 3.5-11 PRN Mapping

Bits	Galileo	GLONASS	BeiDou	GPS	SBAS	QZSS	IRNSS
65	SVID 1	Freq. 1	RCN 1	PRN 1	PRN 120	PRN 183	PRN ID-1
66	SVID 2	Freq. 2	RCN 2	PRN 2	PRN 121	PRN 184	PRN ID-2
67	SVID 3	Freq. 3	RCN 3	PRN 3	PRN 122	PRN 185	PRN ID-3
68	SVID 4	Freq. 4	RCN 4	PRN 4	PRN 123	PRN 186	PRN ID-4
69	SVID 5	Freq. 5	RCN 5	PRN 5	PRN 124	PRN 187	PRN ID-5
70	SVID 6	Freq. 6	RCN 6	PRN 6	PRN 125	PRN 188	PRN ID-6
71	SVID 7	Freq. 7	RCN 7	PRN 7	PRN 126	PRN 189	PRN ID-7
72	SVID 8	Freq. 8	RCN 8	PRN 8	PRN 127	PRN 190	Reserved
73	SVID 9	Freq. 9	RCN 9	PRN 9	PRN 128	PRN 191	Reserved
74	SVID 10	Freq. 10	RCN 10	PRN 10	PRN 129	PRN 192	Reserved
75	SVID 11	Freq. 11	RCN 11	PRN 11	PRN 130	PRN 193	Reserved
76	SVID 12	Freq. 12	RCN 12	PRN 12	PRN 131	PRN 194	Reserved
77	SVID 13	Freq. 13	RCN 13	PRN 13	PRN 132	PRN 195	Reserved
78	SVID 14	Freq. 14	RCN 14	PRN 14	PRN 133	PRN 196	Reserved
79	SVID 15	Freq. 15	RCN 15	PRN 15	PRN 134	PRN 197	Reserved
80	SVID 16	Freq. 16	RCN 16	PRN 16	PRN 135	PRN 198	Reserved
81	SVID 17	Freq. 17	RCN 17	PRN 17	PRN 136	PRN 199	Reserved
82	SVID 18	Freq. 18	RCN 18	PRN 18	PRN 137	PRN 200	Reserved
83	SVID 19	Freq. 19	RCN 19	PRN 19	PRN 138	PRN 201	Reserved
84	SVID 20	Freq. 20	RCN 20	PRN 20	PRN 139	PRN 202	Reserved
85	SVID 21	Freq. 21	RCN 21	PRN 21	PRN 140	Reserved	Reserved
86	SVID 22	Freq. 22	RCN 22	PRN 22	PRN 141	Reserved	Reserved
87	SVID 23	Freq. 23	RCN 23	PRN 23	PRN 142	Reserved	Reserved
88	SVID 24	Freq. 24	RCN 24	PRN 24	PRN 143	Reserved	Reserved
89	SVID 25	Freq. 25	RCN 25	PRN 25	PRN 144	Reserved	Reserved
90	SVID 26	Freq. 26	RCN 26	PRN 26	PRN 145	Reserved	Reserved
91	SVID 27	Freq. 27	RCN 27	PRN 27	PRN 146	Reserved	Reserved
92	SVID 28	Freq. 28	RCN 28	PRN 28	PRN 147	Reserved	Reserved
93	SVID 29	Freq. 29	RCN 29	PRN 29	PRN 148	Reserved	Reserved
94	SVID 30	Freq. 30	RCN 30	PRN 30	PRN 149	Reserved	Reserved
95	SVID 31	Freq. 31	RCN 31	PRN 31	PRN 150	Reserved	Reserved
96	SVID 32	Freq. 32	RCN 32	PRN 32	PRN 151	Reserved	Reserved
97	SVID 33	Reserved	RCN 33	PRN 33	PRN 152	Reserved	Reserved
98	SVID 34	Reserved	RCN 34	PRN 34	PRN 153	Reserved	Reserved
99	SVID 35	Reserved	RCN 35	PRN 35	PRN 154	Reserved	Reserved
100	SVID 36	Reserved	RCN 36	PRN 36	PRN 155	Reserved	Reserved
101	Reserved	Reserved	RCN 37	PRN 37	PRN 156	Reserved	Reserved
102	Reserved	Reserved	Reserved	PRN 38	PRN 157	Reserved	Reserved
103	Reserved	Reserved	Reserved	PRN 39	PRN 158	Reserved	Reserved
104	Reserved	Reserved	Reserved	PRN 40	Reserved	Reserved	Reserved
105	Reserved	Reserved	Reserved	PRN 41	Reserved	Reserved	Reserved
106	Reserved	Reserved	Reserved	PRN 42	Reserved	Reserved	Reserved
107	Reserved	Reserved	Reserved	PRN 43	Reserved	Reserved	Reserved
108	Reserved	Reserved	Reserved	PRN 44	Reserved	Reserved	Reserved
109	Reserved	Reserved	Reserved	PRN 45	Reserved	Reserved	Reserved
110	Reserved	Reserved	Reserved	PRN 46	Reserved	Reserved	Reserved
111	Reserved	Reserved	Reserved	PRN 47	Reserved	Reserved	Reserved
112	Reserved	Reserved	Reserved	PRN 48	Reserved	Reserved	Reserved
113	Reserved	Reserved	Reserved	PRN 49	Reserved	Reserved	Reserved
114	Reserved	Reserved	Reserved	PRN 50	Reserved	Reserved	Reserved
115	Reserved	Reserved	Reserved	PRN 51	Reserved	Reserved	Reserved
116	Reserved	Reserved	Reserved	PRN 52	Reserved	Reserved	Reserved
117	Reserved	Reserved	Reserved	PRN 53	Reserved	Reserved	Reserved
118	Reserved	Reserved	Reserved	PRN 54	Reserved	Reserved	Reserved
119	Reserved	Reserved	Reserved	PRN 55	Reserved	Reserved	Reserved
120	Reserved	Reserved	Reserved	PRN 56	Reserved	Reserved	Reserved

121	Reserved	Reserved	Reserved	PRN 57	Reserved	Reserved	Reserved
122	Reserved	Reserved	Reserved	PRN 58	Reserved	Reserved	Reserved
123	Reserved	Reserved	Reserved	PRN 59	Reserved	Reserved	Reserved
124	Reserved	Reserved	Reserved	PRN 60	Reserved	Reserved	Reserved
125	Reserved	Reserved	Reserved	PRN 61	Reserved	Reserved	Reserved
126	Reserved	Reserved	Reserved	PRN 62	Reserved	Reserved	Reserved
127	Reserved	Reserved	Reserved	PRN 63	Reserved	Reserved	Reserved

SVID = Space Vehicle ID
 Freq. = Carrier Frequency Number
 RCN = Ranging Code Number
 PRN = Pseudorandom Noise Number

3.5.4.7.1.12 Integrity Support Message Cyclic Redundancy Check

Bits 219 through 250 of Subframe 3, Page 8 are a 32-bit Cyclic Redundancy Check (CRC) specific to the ISM parameters. The ISM CRC will cover only the ISM parameters in Subframe 3, Page 8, (Bits 15 to 218). Refer to DO-246E-Change 1 document for more details on the ISM CRC.

3.5.5 Timing Relationships

The following conventions shall apply.

3.5.5.1 Paging and Cutovers

Broadcast sequence of subframe 3 pages is completely arbitrary and, as such, users must not expect a fixed pattern of page sequence.

Cutovers of subframe 2 data to new CEI data sets will nominally occur on hour boundaries except for the first CEI data set of a new CEI data sequence propagation.

3.5.5.2 CEI Data Sets

The following rule governs the transmission of t_{oe} in different CEI data sets: The transmitted t_{oe} will be different from any value transmitted by the SV during the preceding six hours. t_{op} does not have to match t_{oe} .

Cutovers to new CEI data sets will occur only on hour boundaries except for the first CEI data set of a new CEI data sequence propagation. The first CEI data set may be cut-in (reference paragraph 3.5.5.1) at any time during the hour and therefore may be transmitted by the SV for less than one hour.

The start of the transmission interval for each CEI data set corresponds to the beginning of the curve fit interval for the CEI data set. Each CEI data set remains valid for the duration of its transmission interval, and nominally also remains valid for the duration of its curve fit interval. A CEI data set is rendered obsolete before the end of its curve fit interval when it is superseded by the SV cutting over to the first CEI data set of a new CEI data sequence propagation.

Normal Operations. The subframe 2 CEI data sets are transmitted by the SV for periods of two hours. The corresponding curve fit interval is three hours.

Updates to parameters in table 6.2-18 shall prompt changes in t_{oe} . Any parameter marked with NOTE1 may be changed with or without a change in t_{oe} .

3.5.5.3 Reference Times

The CNAV-2 reference time information is similar to that of the CNAV excluding the t_{oc} reference. The CNAV reference time information may be found in paragraph 30.3.4.5 in IS-GPS-200.

6 NOTES

6.1 Acronyms

APC	-	antenna phase center
ARAIM	-	Advanced Receiver Autonomous Integrity Monitoring
ASCII	-	American Standard Code for Information Interchange
BCH	-	Bose, Chaudhuri, and Hocquenghem
BOC	-	Binary Offset Carrier
BPSK	-	Bi-Phase Shift Key
CCB	-	Configuration Control Board
CDC	-	clock differential correction
CEI	-	Clock/Ephemeris/ Integrity
CNAV-2	-	L1C Navigation Message
CRC	-	Cyclic Redundancy Check
CS	-	Control Segment
dBc	-	Power ratio of a signal to a (unmodulated) carrier signal, expressed in decibels
DC	-	differential correction
DN	-	Day Number
ECEF	-	Earth-Centered, Earth-Fixed
ECI	-	Earth-Centered, Inertial
EDC	-	ephemeris differential correction
EOE	-	Edge-of-Earth
EOL	-	End-of-Life
EOP	-	Earth Orientation Parameters
FEC	-	Forward Error Correction
GBAS	-	Ground Based Augmentation System
GGTO	-	GPS/GNSS Time Offset
GNSS	-	Global Navigation Satellite System
GPS	-	Global Positioning System

GPSW	-	GPS Wing
ICC	-	Interface Control Contractor
ICWG	-	Interface Control Working Group
IRN	-	Interface Revision Notice
IS	-	Interface Specification
ISC	-	Inter-Signal Correction
ISM	-	Integrity Support Message
ITOW	-	Interval Time of Week
LDPC	-	Low Density Parity Check
LFSR	-	Linear Feedback Shift Register
LNAV	-	Legacy Navigation Message, D(t)
LSB	-	Least Significant Bit
LSF	-	Leap Seconds Future
L1C	-	Common L1 Signal
MCS	-	Master Control Station
MHz	-	Megahertz
MSB	-	Most Significant Bit
MSO	-	Military Standard Order
NAV	-	Navigation
NSCD	-	non-standard L1C _D
NSCP	-	non-standard L1C _P
PIRN	-	Proposed Interface Revision Notice
PRN	-	Pseudo-Random Noise
RAIM	-	Receiver Autonomous Integrity Monitoring
RF	-	Radio Frequency
RHCP	-	Right-Hand Circularly Polarized
RMS	-	Root Mean Square
SBAS	-	Satellite Based Augmentation System
sps	-	symbols per second

SS	-	Space Segment
SSV	-	Space Service Volume
SV	-	Space Vehicle
TBD	-	To Be Determined
TBR	-	To Be Resolved
TBS	-	To Be Supplied
TMBOC	-	Time-Multiplexed BOC
TOI	-	Time of Interval
TOW	-	Time of Week
TSO	-	Technical Standard Order
UDRA	-	User Differential Range Accuracy
UE	-	User Equipment
URA	-	User Range Accuracy
US	-	User Segment
USNO	-	U.S. Naval Observatory
UTC	-	Coordinated Universal Time
WGS 84	-	World Geodetic System 1984

6.2 Definitions

6.2.1 User Range Accuracy

User Range Accuracy (URA) is a statistical indicator of the GPS ranging accuracy obtainable with a specific signal and SV. URA provides a conservative RMS estimate of the user range error (URE) in the associated navigation data for the transmitting SV. It includes all errors for which the Space and Control Segments are responsible. Whether the integrity status flag is 'off' or 'on', 4.42 times URA bounds the instantaneous URE under all conditions with 1-(1e-5) per hour probability ('legacy' level of integrity assurance). When the integrity status flag is 'on', 5.73 times URA bounds the instantaneous URE under all conditions with 1-(1e-8) per hour probability ('enhanced' level of integrity assurance). Integrity properties of the URA are specified with respect to the scaled (multiplied by either 4.42 or 5.73 as appropriate) upper bound value of the URA index or to the scaled composite of the upper bound values of all component URA indexes.

Note #1: URA applies over the curve fit interval that is applicable to the CNAV-2 data from which the URA is read, for the worst-case location within the satellite footprint.

Note #2: The URA for a particular signal may be represented by a single index in the CNAV-2 data or by a composite of more than one index representing components of the total URA. Specific URA indexes and formulae for calculating the total URA for each signal are defined in Appendix II of IS-GPS-200 for the LNAV message and Appendix III of IS-GPS-200 for the CNAV message.

Note #3: The above integrity assured probability values do not apply if: (a) an alert is issued to the users before the instantaneous URE exceeds either of the scaled URA bounds, or (b) an alert is issued to the users no more than 5.2 seconds after the instantaneous URE exceeds the 4.42 times URA bound, and (c) if the integrity status flag is 'on' and an alert is issued to the users no more than 5.2 seconds after the instantaneous URE exceeds the 5.73 times URA bound. In this context, an "alert" is defined as any indication or characteristic of the conveying signal, as specified elsewhere in this document, which signifies to users that the conveying signal may be invalid or should not be used, such as the health bits not indicating operational-healthy, broadcasting non-standard code, parity error, etc.

6.2.1.1 User Differential Range Accuracy

User Differential Range Accuracy (UDRA) is a statistical indicator of the GPS ranging accuracy obtainable with a specific signal and SV after the application of the associated differential corrections (DC parameters). UDRA provides a conservative RMS estimate of the differential user range errors in the navigation data for that satellite. It includes all errors for which the Space and Control Segments are responsible.

6.2.2 GPS Week Number

The GPS week numbering system is established with week number zero (0) being defined as that week which started with the X1 epoch occurring at midnight UTC(USNO) on the night of January 5, 1980/ morning of January 6, 1980. The GPS week number continuously increments by one (1) at each end/start of week epoch without ever resetting to zero. Users must recognize that the week number information contained in the navigation message may not necessarily reflect the current full GPS week number (see paragraph 3.5.3.1).

6.2.3 Legendre Sequence

The Legendre sequence $L(t)$ of length 10223, defined in Section 3.2.2.1.1, is given in Table 6.2-1.

6.2.4 LDPC Submatrices

This section defines the coordinates of elements with value "1" in each of the submatrices specified in Section 3.2.3.4. Tables 6.2-2, 6.2-3, 6.2-4, 6.2-5, 6.2-6, and 6.2-7 define the coordinates of elements with value "1" in each of the submatrices A, B, C, D, E, and T, respectively, for Subframe 2. Tables 6.2-8, 6.2-9, 6.2-10, 6.2-11, 6.2-12, and 6.2-13 define the coordinates of elements with value "1" in each of the submatrices A, B, C, D, E, and T, respectively, for Subframe 3.

Due to large amount of information provided in some of the submatrix tables, supplemental information is provided in Tables 6.2-14, 6.2-15, 6.2-16, and 6.2-17. The supplemental information tables provide the number of 1's in each row and column of submatrices A and T for subframes 2 and 3.

Table 6.2-1. Legendre Sequence (Octal)

17362522	73143031	34741742	76027406	65416740	15370031	77300273	35501333	33151247	33675050
47166774	40402617	35343610	40736426	77150400	56347466	36245544	14235136	76277137	54514403
43761771	63757753	10410242	61624734	77466552	35205643	12012635	73526361	37265704	13025043
45322543	37432162	77326143	45150310	05107037	54166771	27703137	74542727	45031447	01004237
12273570	15652657	22772517	65350474	54114016	02230023	20076271	43647711	27674121	21171660
67446011	57711024	16221254	31322707	26275421	22673214	65366373	57740342	14365061	14114237
11167632	73150266	77371036	30177233	25366663	22574225	43541714	10240442	53145643	74102765
57024573	71772406	73772650	76463525	67435700	63247125	11061276	57410334	52564011	40607536
04327166	77477642	17073116	33210534	72332534	73060727	31146544	03037511	17021645	12501762
10306066	12006074	72004335	32633605	12752101	77244646	23672177	52462044	62541736	55313003
31650153	60021445	05753416	14426340	05322262	06715512	66162462	33665124	21726377	05106214
60236326	66705713	71543563	60352627	45756540	02651270	47406731	54412044	45121407	10322724
46160571	67206661	66664554	12216361	25747536	16022770	34124777	66602424	61062733	61612036
30215575	12627147	12750552	45761540	04527340	51131031	06640501	15211265	25500450	63377157
17261023	11076665	34472726	21025171	74373774	73231401	75214170	25043117	23754267	57744043
30662311	74563144	54565162	56632723	55751254	50347551	46734531	02104647	52536041	77042562
43106463	74452331	75274175	27330230	55640164	64561770	36243256	11562553	24303426	33067553
26661362	13762326	24040503	63155340	12740027	37165604	57241060	07610146	14730412	05773230
56406443	62032322	04720203	22533503	24700043	52247706	66633026	37301354	54237744	72145047
67666353	11734360	60753126	22576527	46710330	70430313	72734542	05642563	45063606	34401276
24172144	12454475	20105020	47510306	03073516	25121772	07415233	22755042	51042432	22312072
13633455	47060431	33320762	33017222	26357161	44542302	72172633	32353566	53564413	22324741
72007265	30642163	71636641	57365677	24154552	75472075	30127754	31703165	43053505	73454212
02636356	16236611	41250053	31262417	17034206	62431101	01565472	15400334	54427620	31362311
11601532	43577615	23642253	23737215	73232373	03551750	56322005	72756214	71476701	77167520
55705060	21377412	77424463	03657575	31233002	73027111	22441162	31343635	22453046	70523530
36007055	15077504	56336221	24074124	06232554	03151663	53053560	07570252	41515673	66254211
46441436	54526404	43212310	53065054	55463054	06633116	23575400	41134403	20663565	36074724
07746322	14002034	06065367	31212154	25110166	63367120	60460023	16557645	25126724	67657511
66366266	57421255	77447005	52456412	61461312	64044736	30372707	02213167	15353711	00015274
36013370	70241405	27030732	74455111	07111721	06057071	55213236	61747265	55572754	46211741
56126513	77450405	41312437	03043446	02605611	11230337	14731665	60031207	35265102	33153071
12644611	73133225	77431354	70742405	65547377	02476506	23762624	50207453	15573152	40072103
31515520	07672412	65702312	24235772	14171772	71171636	73007652	65507360	66640363	75451466
21217162	14252232	14256722	30662160	73500140	11061235	70241717	46775052	54236740	50127166
65261523	17604341	05243150	16512002	11752006	02055360	45013674	03505462	53557536	74607443
45334053	23111025	22320076	30366020	11136462	12301066	60334674	67165034	73437400	42031025
14722113	27344131	21613226	34527330	75366600	46771541	17106067	27274101	26601503	46130177
23376333	70774674	54156425	00652013	20512504	76042132	60335767	61546365	41213454	00263601
26011074	40361665	76636465	43471220	13072340	23453225	43565362	75605120	27031242	04312772
63505724	32451140	14215307	13536756	62400403	06007003	43754654	40260130	10264334	75445530
31141430	57756460	11350217	56703424	20713757	54011061	56564102	21526462	22227644	22137620
06376024	77410745	11741370	13407414	26363462	13253020				

NOTE: The above sequence is read from left to right across a row and then moves down to the next row.
Since 10224 bits are listed above, a single initial bit value of 0 should be ignored. Thus the first 23 values in the above sequence represented by octal 17362522 are the bit values, 0 1 1 1 0 1 1 1 1 0 0 1 0 1 0 1 0 1 0 0 1 0.

Table 6.2-2. LDPC Submatrix A for Subframe 2 * (sheet 1 of 11)

R , C	R , C	R , C	R , C	R , C	R , C	R , C
1 , 1	9 , 17	21 , 33	432 , 49	263 , 65	534 , 81	112 , 97
151 , 1	62 , 17	228 , 33	449 , 49	366 , 65	559 , 81	196 , 97
440 , 1	456 , 17	299 , 33	549 , 49	402 , 65	206 , 82	102 , 98
131 , 2	26 , 18	363 , 34	206 , 50	123 , 66	510 , 82	233 , 98
197 , 2	154 , 18	387 , 34	248 , 50	172 , 66	520 , 82	405 , 98
552 , 2	380 , 18	496 , 34	590 , 50	441 , 66	186 , 83	109 , 99
105 , 3	178 , 19	46 , 35	212 , 51	101 , 67	215 , 83	148 , 99
378 , 3	420 , 19	76 , 35	473 , 51	389 , 67	348 , 83	312 , 99
461 , 3	529 , 19	219 , 35	525 , 51	555 , 67	252 , 84	66 , 100
83 , 4	40 , 20	87 , 36	132 , 52	237 , 68	374 , 84	155 , 100
404 , 4	235 , 20	350 , 36	424 , 52	280 , 68	483 , 84	247 , 100
501 , 4	397 , 20	393 , 36	459 , 52	429 , 68	185 , 85	288 , 101
67 , 5	59 , 21	199 , 37	157 , 53	108 , 69	298 , 85	386 , 101
227 , 5	285 , 21	442 , 37	345 , 53	413 , 69	499 , 85	543 , 101
584 , 5	411 , 21	586 , 37	470 , 53	585 , 69	246 , 86	10 , 102
333 , 6	273 , 22	266 , 38	35 , 54	271 , 70	307 , 86	107 , 102
431 , 6	376 , 22	329 , 38	297 , 54	335 , 70	464 , 86	547 , 102
563 , 6	598 , 22	568 , 38	564 , 54	410 , 70	39 , 87	103 , 103
17 , 7	259 , 23	231 , 39	139 , 55	78 , 71	254 , 87	128 , 103
250 , 7	326 , 23	465 , 39	175 , 55	97 , 71	418 , 87	355 , 103
427 , 7	528 , 23	532 , 39	495 , 55	530 , 71	56 , 88	190 , 104
137 , 8	120 , 24	152 , 40	13 , 56	63 , 72	117 , 88	390 , 104
310 , 8	203 , 24	336 , 40	72 , 56	372 , 72	481 , 88	587 , 104
373 , 8	434 , 24	394 , 40	202 , 56	526 , 72	268 , 89	129 , 105
116 , 9	194 , 25	45 , 41	73 , 57	18 , 73	421 , 89	383 , 105
279 , 9	213 , 25	80 , 41	315 , 57	265 , 73	454 , 89	597 , 105
522 , 9	399 , 25	125 , 41	401 , 57	382 , 73	337 , 90	61 , 106
42 , 10	11 , 26	357 , 42	225 , 58	75 , 74	489 , 90	242 , 106
184 , 10	479 , 26	560 , 42	238 , 58	158 , 74	524 , 90	351 , 106
369 , 10	557 , 26	573 , 42	362 , 58	167 , 75	127 , 91	171 , 107
218 , 11	93 , 27	113 , 43	328 , 59	234 , 75	283 , 91	216 , 107
426 , 11	110 , 27	406 , 43	447 , 59	457 , 75	486 , 91	506 , 107
491 , 11	575 , 27	468 , 43	588 , 59	95 , 76	31 , 92	98 , 108
89 , 12	241 , 28	165 , 44	136 , 60	482 , 76	88 , 92	193 , 108
306 , 12	379 , 28	187 , 44	293 , 60	505 , 76	416 , 92	591 , 108
438 , 12	537 , 28	358 , 44	476 , 60	55 , 77	8 , 93	54 , 109
169 , 13	5 , 29	23 , 45	4 , 61	150 , 77	174 , 93	64 , 109
295 , 13	92 , 29	282 , 45	276 , 61	301 , 77	578 , 93	220 , 109
593 , 13	222 , 29	314 , 45	544 , 61	86 , 78	52 , 94	340 , 110
48 , 14	189 , 30	41 , 46	38 , 62	261 , 78	294 , 94	367 , 110
341 , 14	255 , 30	287 , 46	141 , 62	519 , 78	316 , 94	536 , 110
509 , 14	540 , 30	569 , 46	342 , 62	29 , 79	82 , 95	12 , 111
70 , 15	104 , 31	144 , 47	192 , 63	318 , 79	253 , 95	43 , 111
142 , 15	518 , 31	462 , 47	452 , 63	497 , 79	548 , 95	260 , 111
353 , 15	565 , 31	503 , 47	539 , 63	114 , 80	69 , 96	30 , 112
126 , 16	133 , 32	180 , 48	407 , 64	182 , 80	275 , 96	146 , 112
291 , 16	256 , 32	320 , 48	437 , 64	243 , 80	553 , 96	448 , 112
453 , 16	409 , 32	582 , 48	507 , 64	492 , 81	15 , 97	200 , 113

* Coordinates of elements with value “1” in submatrix A (599 rows, 600 columns). The coordinates are represented as R, C where R=row and C=column.

Table 6.2-2 LDPC Submatrix A for Subframe 2 * (sheet 2 of 11)

R , C	R , C	R , C	R , C	R , C	R , C	R , C
240 , 113	37 , 129	277 , 145	272 , 161	81 , 177	191 , 193	197 , 209
476 , 113	121 , 129	356 , 145	511 , 161	596 , 177	330 , 193	298 , 209
20 , 114	290 , 130	349 , 146	412 , 162	60 , 178	214 , 194	59 , 210
96 , 114	504 , 130	445 , 146	469 , 162	204 , 178	320 , 194	105 , 210
338 , 114	562 , 130	531 , 146	592 , 162	325 , 178	558 , 194	559 , 210
84 , 115	161 , 131	251 , 147	391 , 163	51 , 179	176 , 195	124 , 211
156 , 115	230 , 131	344 , 147	463 , 163	153 , 179	235 , 195	507 , 211
493 , 115	541 , 131	400 , 147	579 , 163	414 , 179	587 , 195	552 , 211
278 , 116	135 , 132	249 , 148	44 , 164	262 , 180	111 , 196	201 , 212
370 , 116	179 , 132	502 , 148	134 , 164	264 , 180	143 , 196	283 , 212
414 , 116	359 , 132	527 , 148	471 , 164	303 , 180	477 , 196	501 , 212
195 , 117	300 , 133	147 , 149	286 , 165	217 , 181	95 , 197	86 , 213
332 , 117	327 , 133	296 , 149	521 , 165	284 , 181	99 , 197	122 , 213
514 , 117	513 , 133	556 , 149	551 , 165	365 , 181	538 , 197	227 , 213
164 , 118	36 , 134	226 , 150	19 , 166	126 , 182	78 , 198	157 , 214
381 , 118	425 , 134	343 , 150	60 , 166	371 , 182	210 , 198	242 , 214
444 , 118	595 , 134	458 , 150	451 , 166	423 , 182	226 , 198	563 , 214
170 , 119	183 , 135	16 , 151	1 , 167	236 , 183	173 , 199	93 , 215
223 , 119	485 , 135	24 , 151	207 , 167	321 , 183	250 , 199	229 , 215
550 , 119	589 , 135	388 , 151	460 , 167	339 , 183	335 , 199	427 , 215
71 , 120	177 , 136	224 , 152	68 , 168	274 , 184	4 , 200	116 , 216
302 , 120	221 , 136	309 , 152	334 , 168	490 , 184	322 , 200	161 , 216
321 , 120	378 , 136	395 , 152	403 , 168	570 , 184	526 , 200	459 , 216
74 , 121	47 , 137	32 , 153	79 , 169	85 , 185	38 , 201	200 , 217
308 , 121	166 , 137	106 , 153	188 , 169	163 , 185	75 , 201	369 , 217
566 , 121	450 , 137	428 , 153	303 , 169	319 , 185	149 , 201	549 , 217
49 , 122	94 , 138	65 , 154	118 , 170	211 , 186	196 , 202	469 , 218
422 , 122	257 , 138	145 , 154	536 , 170	361 , 186	278 , 202	515 , 218
554 , 122	494 , 138	281 , 154	546 , 170	467 , 186	305 , 202	581 , 218
267 , 123	27 , 139	436 , 155	3 , 171	7 , 187	77 , 203	12 , 219
523 , 123	408 , 139	455 , 155	140 , 171	50 , 187	90 , 203	426 , 219
574 , 123	479 , 139	517 , 155	571 , 171	384 , 187	512 , 203	445 , 219
58 , 124	274 , 140	34 , 156	22 , 172	313 , 188	110 , 204	306 , 220
90 , 124	292 , 140	567 , 156	417 , 172	331 , 188	203 , 204	326 , 220
360 , 124	443 , 140	583 , 156	561 , 172	508 , 188	385 , 204	555 , 220
430 , 125	124 , 141	28 , 157	21 , 173	301 , 189	33 , 205	328 , 221
439 , 125	245 , 141	576 , 157	377 , 173	474 , 189	47 , 205	435 , 221
466 , 125	398 , 141	599 , 157	468 , 173	475 , 189	485 , 205	593 , 221
239 , 126	160 , 142	168 , 158	258 , 174	229 , 190	323 , 206	258 , 222
435 , 126	270 , 142	375 , 158	280 , 174	317 , 190	421 , 206	509 , 222
488 , 126	535 , 142	533 , 158	347 , 174	352 , 190	542 , 206	570 , 222
53 , 127	324 , 143	209 , 159	84 , 175	115 , 191	223 , 207	70 , 223
433 , 127	396 , 143	500 , 159	198 , 175	137 , 191	269 , 207	256 , 223
580 , 127	480 , 143	516 , 159	324 , 175	201 , 191	444 , 207	516 , 223
159 , 128	91 , 144	2 , 160	138 , 176	6 , 192	162 , 208	151 , 224
311 , 128	130 , 144	100 , 160	419 , 176	205 , 192	184 , 208	291 , 224
354 , 128	368 , 144	181 , 160	597 , 176	364 , 192	392 , 208	547 , 224
25 , 129	122 , 145	14 , 161	57 , 177	102 , 193	119 , 209	246 , 225

* Coordinates of elements with value "1" in submatrix A (599 rows, 600 columns). The coordinates are represented as R, C where R=row and C=column.

Table 6.2-2 LDPC Submatrix A for Subframe 2 * (sheet 3 of 11)

R , C	R , C	R , C	R , C	R , C	R , C	R , C
272 , 225	228 , 241	289 , 257	584 , 273	194 , 289	376 , 305	505 , 318
456 , 225	579 , 241	582 , 257	594 , 273	481 , 289	475 , 305	163 , 319
213 , 226	195 , 242	264 , 258	333 , 274	36 , 290	67 , 306	232 , 319
380 , 226	219 , 242	432 , 258	530 , 274	347 , 290	310 , 306	400 , 319
466 , 226	238 , 242	591 , 258	546 , 274	454 , 290	348 , 306	422 , 319
17 , 227	57 , 243	175 , 259	266 , 275	198 , 291	220 , 307	5 , 320
308 , 227	393 , 243	215 , 259	352 , 275	290 , 291	263 , 307	185 , 320
545 , 227	508 , 243	590 , 259	415 , 275	524 , 291	337 , 307	375 , 320
353 , 228	342 , 244	189 , 260	37 , 276	135 , 292	176 , 308	430 , 320
420 , 228	442 , 244	212 , 260	265 , 276	208 , 292	267 , 308	3 , 321
449 , 228	452 , 244	367 , 260	493 , 276	245 , 292	472 , 308	239 , 321
40 , 229	329 , 245	49 , 261	123 , 277	88 , 293	29 , 309	423 , 321
112 , 229	360 , 245	470 , 261	346 , 277	111 , 293	72 , 309	529 , 321
518 , 229	374 , 245	497 , 261	535 , 277	431 , 293	286 , 309	354 , 322
145 , 230	425 , 246	45 , 262	25 , 278	91 , 294	94 , 310	366 , 322
180 , 230	537 , 246	140 , 262	136 , 278	113 , 294	296 , 310	391 , 322
598 , 230	572 , 246	564 , 262	236 , 278	532 , 294	586 , 310	143 , 323
243 , 231	30 , 247	139 , 263	284 , 279	61 , 295	18 , 311	183 , 323
528 , 231	231 , 247	503 , 263	457 , 279	148 , 295	87 , 311	279 , 323
585 , 231	489 , 247	533 , 263	494 , 279	522 , 295	179 , 311	411 , 323
120 , 232	16 , 248	202 , 264	83 , 280	71 , 296	513 , 311	54 , 324
177 , 232	48 , 248	370 , 264	146 , 280	82 , 296	343 , 312	121 , 324
253 , 232	504 , 248	439 , 264	566 , 280	458 , 296	408 , 312	502 , 324
103 , 233	132 , 249	73 , 265	114 , 281	247 , 297	544 , 312	541 , 324
338 , 233	386 , 249	350 , 265	150 , 281	417 , 297	595 , 312	13 , 325
446 , 233	394 , 249	534 , 265	578 , 281	424 , 297	50 , 313	106 , 325
107 , 234	344 , 250	294 , 266	118 , 282	292 , 298	81 , 313	174 , 325
138 , 234	438 , 250	362 , 266	216 , 282	405 , 298	373 , 313	359 , 325
399 , 234	573 , 250	418 , 266	261 , 282	558 , 298	491 , 313	251 , 326
11 , 235	165 , 251	8 , 267	486 , 283	109 , 299	74 , 314	327 , 326
363 , 235	205 , 251	28 , 267	550 , 283	127 , 299	234 , 314	538 , 326
523 , 235	406 , 251	539 , 267	557 , 283	377 , 299	433 , 314	565 , 326
80 , 236	42 , 252	128 , 268	182 , 284	155 , 300	553 , 314	130 , 327
233 , 236	312 , 252	437 , 268	381 , 284	355 , 300	171 , 315	153 , 327
575 , 236	560 , 252	506 , 268	434 , 284	499 , 300	387 , 315	273 , 327
379 , 237	295 , 253	224 , 269	89 , 285	98 , 301	404 , 315	527 , 327
389 , 237	358 , 253	402 , 269	159 , 285	164 , 301	413 , 315	10 , 328
569 , 237	396 , 253	477 , 269	199 , 285	543 , 301	96 , 316	270 , 328
92 , 238	1 , 254	316 , 270	299 , 286	248 , 302	115 , 316	281 , 328
193 , 238	23 , 254	441 , 270	372 , 286	339 , 302	548 , 316	287 , 328
282 , 238	436 , 254	589 , 270	510 , 286	351 , 302	554 , 316	221 , 329
66 , 239	41 , 255	101 , 271	108 , 287	53 , 303	58 , 317	349 , 329
170 , 239	249 , 255	313 , 271	464 , 287	186 , 303	318 , 317	480 , 329
540 , 239	453 , 255	410 , 271	483 , 287	271 , 303	382 , 317	520 , 329
63 , 240	187 , 256	237 , 272	39 , 288	260 , 304	397 , 317	156 , 330
104 , 240	462 , 256	357 , 272	259 , 288	383 , 304	52 , 318	178 , 330
496 , 240	487 , 256	384 , 272	336 , 288	461 , 304	302 , 318	443 , 330
134 , 241	167 , 257	15 , 273	69 , 289	323 , 305	471 , 318	467 , 330

* Coordinates of elements with value "1" in submatrix A (599 rows, 600 columns). The coordinates are represented as R, C where R=row and C=column.

Table 6.2-2 LDPC Submatrix A for Subframe 2 * (sheet 4 of 11)

R , C	R , C	R , C	R , C	R , C	R , C	R , C
188 , 331	44 , 343	398 , 354	100 , 364	431 , 373	284 , 383	79 , 393
388 , 331	241 , 343	409 , 354	138 , 364	44 , 374	316 , 383	252 , 393
514 , 331	285 , 343	117 , 355	172 , 364	196 , 374	563 , 383	380 , 393
521 , 331	385 , 343	315 , 355	369 , 364	247 , 374	30 , 384	459 , 393
154 , 332	65 , 344	371 , 355	10 , 365	330 , 374	137 , 384	475 , 393
450 , 332	207 , 344	448 , 355	76 , 365	548 , 374	513 , 384	61 , 394
519 , 332	482 , 344	463 , 355	322 , 365	166 , 375	573 , 384	102 , 394
574 , 332	490 , 344	35 , 356	437 , 365	214 , 375	591 , 384	238 , 394
31 , 333	168 , 345	191 , 356	451 , 365	269 , 375	46 , 385	290 , 394
125 , 333	204 , 345	311 , 356	68 , 366	527 , 375	65 , 385	545 , 394
390 , 333	334 , 345	460 , 356	144 , 366	593 , 375	116 , 385	283 , 395
395 , 333	577 , 345	511 , 356	318 , 366	162 , 376	175 , 385	325 , 395
99 , 334	173 , 346	6 , 357	455 , 366	241 , 376	334 , 385	420 , 395
160 , 334	276 , 346	26 , 357	549 , 366	273 , 376	82 , 386	428 , 395
474 , 334	340 , 346	341 , 357	7 , 367	310 , 376	452 , 386	505 , 395
488 , 334	517 , 346	403 , 357	149 , 367	342 , 376	534 , 386	40 , 396
141 , 335	43 , 347	419 , 357	198 , 367	48 , 377	568 , 386	54 , 396
217 , 335	268 , 347	20 , 358	317 , 367	197 , 377	581 , 386	100 , 396
293 , 335	275 , 347	84 , 358	331 , 367	359 , 377	237 , 387	223 , 396
525 , 335	300 , 347	304 , 358	2 , 368	538 , 377	403 , 387	463 , 396
46 , 336	22 , 348	440 , 358	32 , 368	558 , 377	426 , 387	64 , 397
288 , 336	429 , 348	588 , 358	472 , 368	47 , 378	555 , 387	134 , 397
345 , 336	567 , 348	244 , 359	540 , 368	105 , 378	598 , 387	193 , 397
368 , 336	599 , 348	252 , 359	596 , 368	248 , 378	125 , 388	528 , 397
77 , 337	24 , 349	416 , 359	169 , 369	294 , 378	184 , 388	597 , 397
142 , 337	218 , 349	495 , 359	319 , 369	408 , 378	207 , 388	17 , 398
551 , 337	254 , 349	580 , 359	346 , 369	14 , 379	266 , 388	28 , 398
561 , 337	498 , 349	158 , 360	365 , 369	145 , 379	306 , 388	120 , 398
166 , 338	240 , 350	210 , 360	378 , 369	351 , 379	42 , 389	151 , 398
277 , 338	255 , 350	214 , 360	167 , 370	466 , 379	73 , 389	347 , 398
297 , 338	465 , 350	508 , 360	349 , 370	552 , 379	246 , 389	29 , 399
314 , 338	556 , 350	571 , 360	447 , 370	139 , 380	509 , 389	99 , 399
56 , 339	152 , 351	14 , 361	473 , 370	154 , 380	575 , 389	277 , 399
131 , 339	192 , 351	75 , 361	576 , 370	254 , 380	70 , 390	446 , 399
428 , 339	307 , 351	262 , 361	9 , 371	392 , 380	203 , 390	493 , 399
592 , 339	356 , 351	325 , 361	85 , 371	405 , 380	425 , 390	37 , 400
133 , 340	181 , 352	484 , 361	336 , 371	148 , 381	510 , 390	113 , 400
144 , 340	309 , 352	34 , 362	469 , 371	173 , 381	585 , 390	399 , 400
531 , 340	407 , 352	89 , 362	476 , 371	416 , 381	12 , 391	485 , 400
568 , 340	500 , 352	225 , 362	64 , 372	501 , 381	291 , 391	562 , 400
19 , 341	51 , 353	249 , 362	78 , 372	570 , 381	366 , 391	11 , 401
209 , 341	62 , 353	412 , 362	169 , 372	91 , 382	543 , 391	22 , 401
478 , 341	190 , 353	33 , 363	406 , 372	119 , 382	584 , 391	213 , 401
562 , 341	222 , 353	97 , 363	427 , 372	227 , 382	26 , 392	355 , 401
257 , 342	583 , 353	129 , 363	27 , 373	474 , 382	59 , 392	578 , 401
322 , 342	230 , 354	147 , 363	55 , 373	496 , 382	181 , 392	4 , 402
332 , 342	305 , 354	492 , 363	211 , 373	189 , 383	228 , 392	56 , 402
401 , 342	364 , 354	79 , 364	259 , 373	275 , 383	456 , 392	379 , 402

* Coordinates of elements with value "1" in submatrix A (599 rows, 600 columns). The coordinates are represented as R, C where R=row and C=column.

Table 6.2-2 LDPC Submatrix A for Subframe 2 * (sheet 5 of 11)

R , C	R , C	R , C	R , C	R , C	R , C	R , C
443 , 402	176 , 412	114 , 422	396 , 431	357 , 441	404 , 450	296 , 460
92 , 403	231 , 412	225 , 422	530 , 431	436 , 441	25 , 451	488 , 460
338 , 403	260 , 412	234 , 422	24 , 432	477 , 441	98 , 451	580 , 460
358 , 403	15 , 413	464 , 422	261 , 432	521 , 441	424 , 451	191 , 461
411 , 403	375 , 413	564 , 422	397 , 432	215 , 442	451 , 451	200 , 461
417 , 403	394 , 413	121 , 423	421 , 432	287 , 442	473 , 451	320 , 461
104 , 404	438 , 413	127 , 423	526 , 432	382 , 442	2 , 452	499 , 461
274 , 404	487 , 413	288 , 423	265 , 433	491 , 442	186 , 452	589 , 461
321 , 404	180 , 414	362 , 423	315 , 433	515 , 442	236 , 452	20 , 462
430 , 404	226 , 414	531 , 423	387 , 433	178 , 443	386 , 452	281 , 462
586 , 404	547 , 414	86 , 424	519 , 433	483 , 443	400 , 452	326 , 462
80 , 405	560 , 414	126 , 424	599 , 433	525 , 443	33 , 453	414 , 462
87 , 405	577 , 414	280 , 424	123 , 434	554 , 443	285 , 453	542 , 462
256 , 405	23 , 415	328 , 424	339 , 434	567 , 443	356 , 453	172 , 463
337 , 405	71 , 415	471 , 424	504 , 434	159 , 444	503 , 453	195 , 463
546 , 405	109 , 415	38 , 425	556 , 434	211 , 444	587 , 453	232 , 463
111 , 406	157 , 415	174 , 425	583 , 434	298 , 444	183 , 454	314 , 463
271 , 406	305 , 415	390 , 425	136 , 435	514 , 444	304 , 454	479 , 463
363 , 406	41 , 416	444 , 425	299 , 435	596 , 444	383 , 454	115 , 464
482 , 406	103 , 416	520 , 425	308 , 435	39 , 445	538 , 454	258 , 464
595 , 406	217 , 416	93 , 426	312 , 435	60 , 445	574 , 454	413 , 464
58 , 407	395 , 416	361 , 426	481 , 435	108 , 445	7 , 455	533 , 464
219 , 407	434 , 416	370 , 426	83 , 436	122 , 445	242 , 455	544 , 464
250 , 407	77 , 417	478 , 426	204 , 436	267 , 445	263 , 455	66 , 465
439 , 407	243 , 417	539 , 426	229 , 436	215 , 446	468 , 455	163 , 465
523 , 407	257 , 417	147 , 427	286 , 436	301 , 446	498 , 455	292 , 465
35 , 408	462 , 417	374 , 427	461 , 436	341 , 446	53 , 456	458 , 465
95 , 408	590 , 417	402 , 427	31 , 437	550 , 446	72 , 456	572 , 465
170 , 408	150 , 418	480 , 427	133 , 437	588 , 446	376 , 456	57 , 466
372 , 408	251 , 418	511 , 427	303 , 437	55 , 447	517 , 456	74 , 466
393 , 408	353 , 418	88 , 428	311 , 437	135 , 447	592 , 456	128 , 466
155 , 409	497 , 418	140 , 428	557 , 437	209 , 447	216 , 457	364 , 466
332 , 409	582 , 418	164 , 428	131 , 438	454 , 447	239 , 457	529 , 466
435 , 409	432 , 419	177 , 428	182 , 438	465 , 447	307 , 457	141 , 467
442 , 409	516 , 419	441 , 428	313 , 438	171 , 448	343 , 457	233 , 467
566 , 409	522 , 419	81 , 429	348 , 438	208 , 448	377 , 457	302 , 467
118 , 410	535 , 419	224 , 429	541 , 438	345 , 448	43 , 458	492 , 467
202 , 410	576 , 419	340 , 429	62 , 439	391 , 448	220 , 458	500 , 467
329 , 410	68 , 420	532 , 429	69 , 439	561 , 448	352 , 458	190 , 468
410 , 410	212 , 420	594 , 429	161 , 439	253 , 449	373 , 458	279 , 468
457 , 410	245 , 420	21 , 430	165 , 439	293 , 449	429 , 458	299 , 468
188 , 411	324 , 420	389 , 430	506 , 439	333 , 449	85 , 459	323 , 468
235 , 411	412 , 420	449 , 430	49 , 440	371 , 449	230 , 459	344 , 468
282 , 411	101 , 421	494 , 430	110 , 440	398 , 449	367 , 459	360 , 468
407 , 411	129 , 421	524 , 430	117 , 440	112 , 450	495 , 459	445 , 468
537 , 411	206 , 421	8 , 431	199 , 440	124 , 450	559 , 459	107 , 469
5 , 412	276 , 421	160 , 431	551 , 440	295 , 450	18 , 460	132 , 469
142 , 412	470 , 421	201 , 431	45 , 441	353 , 450	194 , 460	240 , 469

* Coordinates of elements with value "1" in submatrix A (599 rows, 600 columns). The coordinates are represented as R, C where R=row and C=column.

Table 6.2-2 LDPC Submatrix A for Subframe 2 * (sheet 6 of 11)

R , C	R , C	R , C	R , C	R , C	R , C	R , C
317 , 469	90 , 476	19 , 481	258 , 484	452 , 487	496 , 490	547 , 493
327 , 469	146 , 476	97 , 481	269 , 484	481 , 487	517 , 490	28 , 494
433 , 469	168 , 476	119 , 481	298 , 484	513 , 487	520 , 490	49 , 494
490 , 469	192 , 476	124 , 481	313 , 484	552 , 487	563 , 490	103 , 494
96 , 470	381 , 476	152 , 481	378 , 484	555 , 487	41 , 491	132 , 494
106 , 470	179 , 477	158 , 481	395 , 484	587 , 487	137 , 491	188 , 494
205 , 470	218 , 477	229 , 481	398 , 484	599 , 487	153 , 491	202 , 494
238 , 470	222 , 477	234 , 481	475 , 484	42 , 488	168 , 491	205 , 494
244 , 470	330 , 477	344 , 481	489 , 484	56 , 488	178 , 491	246 , 494
268 , 470	401 , 477	431 , 481	568 , 484	89 , 488	245 , 491	301 , 494
354 , 470	489 , 477	455 , 481	586 , 484	126 , 488	261 , 491	310 , 494
1 , 471	571 , 477	471 , 481	21 , 485	231 , 488	267 , 491	334 , 494
94 , 471	27 , 478	557 , 481	60 , 485	294 , 488	339 , 491	485 , 494
154 , 471	262 , 478	569 , 481	63 , 485	382 , 488	362 , 491	512 , 494
210 , 471	278 , 478	105 , 482	150 , 485	410 , 488	426 , 491	524 , 494
486 , 471	300 , 478	128 , 482	162 , 485	445 , 488	462 , 491	593 , 494
536 , 471	335 , 478	144 , 482	189 , 485	449 , 488	521 , 491	39 , 495
553 , 471	450 , 478	149 , 482	249 , 485	477 , 488	558 , 491	66 , 495
187 , 472	463 , 478	222 , 482	278 , 485	501 , 488	581 , 491	70 , 495
221 , 472	3 , 479	226 , 482	296 , 485	506 , 488	7 , 492	83 , 495
392 , 472	9 , 479	297 , 482	332 , 485	579 , 488	57 , 492	117 , 495
409 , 472	67 , 479	336 , 482	394 , 485	585 , 488	96 , 492	359 , 495
453 , 472	130 , 479	366 , 482	425 , 485	16 , 489	122 , 492	386 , 495
484 , 472	185 , 479	396 , 482	554 , 485	22 , 489	145 , 492	441 , 495
565 , 472	255 , 479	399 , 482	591 , 485	44 , 489	221 , 492	446 , 495
13 , 473	365 , 479	415 , 482	27 , 486	136 , 489	260 , 492	466 , 495
63 , 473	385 , 479	440 , 482	141 , 486	187 , 489	295 , 492	508 , 495
156 , 473	422 , 479	473 , 482	160 , 486	199 , 489	335 , 492	525 , 495
270 , 473	460 , 479	519 , 482	197 , 486	227 , 489	343 , 492	549 , 495
309 , 473	467 , 479	29 , 483	207 , 486	266 , 489	369 , 492	560 , 495
384 , 473	518 , 479	104 , 483	224 , 486	276 , 489	412 , 492	597 , 495
418 , 473	569 , 479	116 , 483	235 , 486	304 , 489	434 , 492	47 , 496
16 , 474	579 , 479	153 , 483	252 , 486	318 , 489	534 , 492	114 , 496
52 , 474	23 , 480	172 , 483	312 , 486	370 , 489	546 , 492	190 , 496
143 , 474	32 , 480	293 , 483	328 , 486	464 , 489	40 , 493	200 , 496
289 , 474	36 , 480	325 , 483	338 , 486	522 , 489	86 , 493	230 , 496
368 , 474	51 , 480	352 , 483	393 , 486	530 , 489	182 , 493	250 , 496
444 , 474	76 , 480	390 , 483	427 , 486	15 , 490	248 , 493	287 , 496
566 , 474	264 , 480	402 , 483	543 , 486	32 , 490	284 , 493	291 , 496
34 , 475	274 , 480	406 , 483	562 , 486	58 , 490	306 , 493	303 , 496
256 , 475	319 , 480	447 , 483	54 , 487	123 , 490	354 , 493	429 , 496
272 , 475	331 , 480	465 , 483	91 , 487	165 , 490	363 , 493	436 , 496
388 , 475	350 , 480	509 , 483	173 , 487	179 , 490	384 , 493	474 , 496
415 , 475	419 , 480	545 , 483	208 , 487	201 , 490	430 , 493	526 , 496
423 , 475	448 , 480	11 , 484	243 , 487	239 , 490	478 , 493	575 , 496
507 , 475	502 , 480	46 , 484	333 , 487	281 , 490	484 , 493	596 , 496
4 , 476	512 , 480	50 , 484	400 , 487	355 , 490	492 , 493	30 , 497
50 , 476	6 , 481	69 , 484	420 , 487	493 , 490	532 , 493	170 , 497

* Coordinates of elements with value "1" in submatrix A (599 rows, 600 columns). The coordinates are represented as R, C where R=row and C=column.

Table 6.2-2 LDPC Submatrix A for Subframe 2 * (sheet 7 of 11)

R , C	R , C	R , C	R , C	R , C	R , C	R , C
203 , 497	279 , 500	379 , 503	435 , 506	573 , 509	100 , 513	251 , 516
212 , 497	340 , 500	413 , 503	548 , 506	8 , 510	130 , 513	273 , 516
302 , 497	371 , 500	417 , 503	578 , 506	31 , 510	164 , 513	280 , 516
326 , 497	385 , 500	432 , 503	583 , 506	61 , 510	233 , 513	330 , 516
443 , 497	428 , 500	440 , 503	35 , 507	139 , 510	282 , 513	421 , 516
456 , 497	497 , 500	453 , 503	43 , 507	193 , 510	307 , 513	451 , 516
459 , 497	564 , 500	479 , 503	85 , 507	196 , 510	317 , 513	467 , 516
498 , 497	572 , 500	13 , 504	112 , 507	206 , 510	320 , 513	469 , 516
515 , 497	590 , 500	25 , 504	115 , 507	323 , 510	409 , 513	480 , 516
523 , 497	598 , 500	92 , 504	131 , 507	327 , 510	418 , 513	561 , 516
533 , 497	45 , 501	180 , 504	167 , 507	348 , 510	494 , 513	34 , 517
553 , 497	72 , 501	198 , 504	216 , 507	368 , 510	510 , 513	36 , 517
594 , 497	93 , 501	213 , 504	288 , 507	457 , 510	588 , 513	79 , 517
5 , 498	142 , 501	241 , 504	357 , 507	499 , 510	90 , 514	127 , 517
20 , 498	151 , 501	257 , 504	407 , 507	507 , 510	107 , 514	215 , 517
73 , 498	155 , 501	346 , 504	442 , 507	595 , 510	118 , 514	220 , 517
111 , 498	218 , 501	405 , 504	472 , 507	12 , 511	161 , 514	240 , 517
174 , 498	236 , 501	408 , 504	504 , 507	64 , 511	223 , 514	309 , 517
217 , 498	265 , 501	414 , 504	571 , 507	95 , 511	254 , 514	360 , 517
263 , 498	341 , 501	455 , 504	17 , 508	101 , 511	277 , 514	401 , 517
356 , 498	374 , 501	483 , 504	38 , 508	108 , 511	283 , 514	404 , 517
361 , 498	389 , 501	491 , 504	80 , 508	146 , 511	311 , 514	444 , 517
380 , 498	505 , 501	1 , 505	147 , 508	163 , 511	321 , 514	535 , 517
437 , 498	528 , 501	106 , 505	157 , 508	214 , 511	383 , 514	574 , 517
527 , 498	541 , 501	143 , 505	186 , 508	262 , 511	423 , 514	577 , 517
556 , 498	68 , 502	169 , 505	195 , 508	364 , 511	469 , 514	21 , 518
565 , 498	71 , 502	194 , 505	209 , 508	424 , 511	576 , 514	24 , 518
589 , 498	98 , 502	228 , 505	372 , 508	454 , 511	584 , 514	50 , 518
59 , 499	120 , 502	242 , 505	411 , 508	503 , 511	62 , 515	53 , 518
75 , 499	191 , 502	253 , 505	450 , 508	551 , 511	65 , 515	55 , 518
135 , 499	210 , 502	349 , 505	461 , 508	580 , 511	71 , 515	99 , 518
138 , 499	270 , 502	373 , 505	476 , 508	10 , 512	113 , 515	148 , 518
159 , 499	337 , 502	387 , 505	537 , 508	74 , 512	149 , 515	244 , 518
176 , 499	342 , 502	438 , 505	567 , 508	78 , 512	152 , 515	297 , 518
237 , 499	351 , 502	539 , 505	125 , 509	110 , 512	289 , 515	324 , 518
305 , 499	375 , 502	542 , 505	166 , 509	133 , 512	315 , 515	448 , 518
329 , 499	391 , 502	570 , 505	204 , 509	177 , 512	397 , 515	460 , 518
381 , 499	529 , 502	2 , 506	272 , 509	183 , 512	416 , 515	490 , 518
422 , 499	540 , 502	37 , 506	290 , 509	192 , 512	433 , 515	516 , 518
482 , 499	559 , 502	77 , 506	316 , 509	247 , 512	447 , 515	550 , 518
486 , 499	48 , 503	88 , 506	322 , 509	268 , 512	514 , 515	14 , 519
582 , 499	87 , 503	129 , 506	347 , 509	314 , 512	538 , 515	26 , 519
592 , 499	134 , 503	184 , 506	439 , 509	345 , 512	544 , 515	41 , 519
84 , 500	175 , 503	219 , 506	470 , 509	403 , 512	81 , 516	52 , 519
102 , 500	271 , 503	292 , 506	488 , 509	449 , 512	94 , 516	67 , 519
121 , 500	275 , 503	358 , 506	500 , 509	487 , 512	109 , 516	97 , 519
171 , 500	286 , 503	367 , 506	531 , 509	18 , 513	140 , 516	211 , 519
259 , 500	308 , 503	376 , 506	536 , 509	82 , 513	181 , 516	232 , 519

* Coordinates of elements with value "1" in submatrix A (599 rows, 600 columns). The coordinates are represented as R, C where R=row and C=column.

Table 6.2-2 LDPC Submatrix A for Subframe 2 * (sheet 8 of 11)

R , C	R , C	R , C	R , C	R , C	R , C	R , C
285 , 519	518 , 522	585 , 525	131 , 529	154 , 532	367 , 535	426 , 538
300 , 519	522 , 522	57 , 526	146 , 529	214 , 532	379 , 535	546 , 538
350 , 519	559 , 522	76 , 526	165 , 529	237 , 532	425 , 535	590 , 538
353 , 519	595 , 522	150 , 526	238 , 529	306 , 532	490 , 535	7 , 539
377 , 519	9 , 523	177 , 526	312 , 529	332 , 532	556 , 535	22 , 539
495 , 519	192 , 523	186 , 526	323 , 529	501 , 532	575 , 535	70 , 539
576 , 519	197 , 523	204 , 526	342 , 529	534 , 532	38 , 536	115 , 539
19 , 520	256 , 523	303 , 526	350 , 529	560 , 532	45 , 536	133 , 539
33 , 520	264 , 523	371 , 526	435 , 529	562 , 532	85 , 536	157 , 539
156 , 520	276 , 523	387 , 526	523 , 529	6 , 533	189 , 536	185 , 539
175 , 520	295 , 523	396 , 526	569 , 529	11 , 533	266 , 536	191 , 539
185 , 520	360 , 523	402 , 526	589 , 529	28 , 533	272 , 536	233 , 539
225 , 520	363 , 523	462 , 526	60 , 530	51 , 533	298 , 536	310 , 539
250 , 520	390 , 523	471 , 526	76 , 530	95 , 533	365 , 536	327 , 539
388 , 520	494 , 523	499 , 526	96 , 530	106 , 533	369 , 536	416 , 539
419 , 520	521 , 523	543 , 526	277 , 530	203 , 533	403 , 536	454 , 539
442 , 520	550 , 523	28 , 527	293 , 530	227 , 533	431 , 536	527 , 539
458 , 520	571 , 523	35 , 527	304 , 530	231 , 533	458 , 536	536 , 539
468 , 520	586 , 523	105 , 527	324 , 530	271 , 533	466 , 536	31 , 540
483 , 520	3 , 524	159 , 527	355 , 530	375 , 533	503 , 536	42 , 540
489 , 520	91 , 524	207 , 527	405 , 530	422 , 533	542 , 536	97 , 540
511 , 520	102 , 524	280 , 527	433 , 530	441 , 533	53 , 537	113 , 540
13 , 521	111 , 524	331 , 527	459 , 530	509 , 533	67 , 537	202 , 540
17 , 521	128 , 524	345 , 527	473 , 530	598 , 533	114 , 537	209 , 540
65 , 521	261 , 524	444 , 527	477 , 530	73 , 534	142 , 537	267 , 540
77 , 521	300 , 524	478 , 527	552 , 530	118 , 534	198 , 537	320 , 540
103 , 521	319 , 524	546 , 527	593 , 530	176 , 534	239 , 537	328 , 540
158 , 521	345 , 524	549 , 527	2 , 531	211 , 534	259 , 537	380 , 540
222 , 521	394 , 524	565 , 527	58 , 531	336 , 534	309 , 537	448 , 540
255 , 521	398 , 524	587 , 527	167 , 531	348 , 534	314 , 537	481 , 540
357 , 521	456 , 524	12 , 528	213 , 531	370 , 534	330 , 537	518 , 540
377 , 521	480 , 524	25 , 528	218 , 531	386 , 534	432 , 537	548 , 540
413 , 521	486 , 524	149 , 528	278 , 531	389 , 534	484 , 537	596 , 540
502 , 521	577 , 524	162 , 528	280 , 531	393 , 534	502 , 537	20 , 541
507 , 521	51 , 525	164 , 528	392 , 531	407 , 534	506 , 537	36 , 541
511 , 521	90 , 525	172 , 528	419 , 531	492 , 534	581 , 537	39 , 541
594 , 521	94 , 525	182 , 528	427 , 531	526 , 534	4 , 538	47 , 541
6 , 522	122 , 525	285 , 528	438 , 531	563 , 534	23 , 538	49 , 541
29 , 522	139 , 525	294 , 528	465 , 531	580 , 534	112 , 538	273 , 541
221 , 522	148 , 525	388 , 528	553 , 531	32 , 535	156 , 538	283 , 541
243 , 522	230 , 525	404 , 528	558 , 531	34 , 535	158 , 538	382 , 541
252 , 522	236 , 525	437 , 528	572 , 531	78 , 535	179 , 538	391 , 541
291 , 522	270 , 525	464 , 528	35 , 532	137 , 535	235 , 538	452 , 541
331 , 522	329 , 525	497 , 528	48 , 532	181 , 535	287 , 538	461 , 541
358 , 522	352 , 525	539 , 528	74 , 532	208 , 535	301 , 538	478 , 541
362 , 522	365 , 525	24 , 529	100 , 532	257 , 535	308 , 538	545 , 541
372 , 522	428 , 525	63 , 529	116 , 532	318 , 535	354 , 538	564 , 541
488 , 522	573 , 525	105 , 529	129 , 532	349 , 535	383 , 538	592 , 541

* Coordinates of elements with value "1" in submatrix A (599 rows, 600 columns). The coordinates are represented as R, C where R=row and C=column.

Table 6.2-2 LDPC Submatrix A for Subframe 2 * (sheet 9 of 11)

R , C	R , C	R , C	R , C	R , C	R , C	R , C
40 , 542	120 , 545	132 , 548	296 , 551	470 , 554	14 , 558	110 , 561
62 , 542	153 , 545	140 , 548	455 , 551	487 , 554	16 , 558	135 , 561
83 , 542	184 , 545	311 , 548	516 , 551	495 , 554	88 , 558	172 , 561
121 , 542	225 , 545	325 , 548	519 , 551	10 , 555	117 , 558	215 , 561
159 , 542	281 , 545	333 , 548	568 , 551	19 , 555	234 , 558	279 , 561
194 , 542	289 , 545	411 , 548	579 , 551	37 , 555	240 , 558	312 , 561
264 , 542	299 , 545	533 , 548	84 , 552	226 , 555	374 , 558	363 , 561
344 , 542	440 , 545	540 , 548	127 , 552	255 , 555	430 , 558	378 , 561
366 , 542	463 , 545	588 , 548	147 , 552	282 , 555	450 , 558	442 , 561
410 , 542	504 , 545	54 , 549	180 , 552	302 , 555	467 , 558	573 , 561
412 , 542	541 , 545	104 , 549	183 , 552	331 , 555	475 , 558	584 , 561
420 , 542	561 , 545	143 , 549	206 , 552	338 , 555	482 , 558	596 , 561
472 , 542	33 , 546	174 , 549	305 , 552	373 , 555	512 , 558	63 , 562
491 , 542	61 , 546	207 , 549	339 , 552	397 , 555	515 , 558	98 , 562
498 , 542	89 , 546	216 , 549	406 , 552	479 , 555	531 , 558	124 , 562
8 , 543	125 , 546	245 , 549	417 , 552	513 , 555	52 , 559	173 , 562
59 , 543	151 , 546	275 , 549	421 , 552	530 , 555	69 , 559	176 , 562
66 , 543	168 , 546	315 , 549	434 , 552	584 , 555	109 , 559	201 , 562
101 , 543	217 , 546	364 , 549	474 , 552	30 , 556	119 , 559	247 , 562
161 , 543	260 , 546	436 , 549	578 , 552	75 , 556	130 , 559	256 , 562
199 , 543	288 , 546	500 , 549	591 , 552	79 , 556	163 , 559	265 , 562
220 , 543	321 , 546	524 , 549	201 , 553	82 , 556	187 , 559	269 , 562
244 , 543	400 , 546	547 , 549	249 , 553	123 , 556	241 , 559	284 , 562
274 , 543	408 , 546	557 , 549	253 , 553	126 , 556	341 , 559	436 , 562
307 , 543	446 , 546	27 , 550	286 , 553	144 , 556	359 , 559	447 , 562
334 , 543	460 , 546	68 , 550	313 , 553	160 , 556	362 , 559	553 , 562
340 , 543	537 , 546	81 , 550	316 , 553	166 , 556	529 , 559	561 , 562
347 , 543	18 , 547	93 , 550	351 , 553	193 , 556	535 , 559	8 , 563
414 , 543	46 , 547	108 , 550	356 , 553	265 , 556	544 , 559	38 , 563
496 , 543	72 , 547	228 , 550	415 , 553	268 , 556	583 , 559	148 , 563
26 , 544	99 , 547	290 , 550	418 , 553	385 , 556	4 , 560	154 , 563
80 , 544	145 , 547	384 , 550	505 , 553	485 , 556	55 , 560	162 , 563
188 , 544	224 , 547	401 , 550	525 , 553	587 , 556	67 , 560	229 , 563
190 , 544	242 , 547	468 , 550	574 , 553	56 , 557	173 , 560	239 , 563
248 , 544	279 , 547	476 , 550	582 , 553	152 , 557	196 , 560	316 , 563
251 , 544	284 , 547	493 , 550	599 , 553	169 , 557	337 , 560	336 , 563
317 , 544	319 , 547	514 , 550	3 , 554	171 , 557	346 , 560	400 , 563
322 , 544	399 , 547	554 , 550	134 , 554	210 , 557	357 , 560	467 , 563
368 , 544	424 , 547	565 , 550	170 , 554	223 , 557	376 , 560	504 , 563
447 , 544	443 , 547	87 , 551	195 , 554	232 , 557	395 , 560	523 , 563
520 , 544	508 , 547	136 , 551	246 , 554	326 , 557	402 , 560	538 , 563
528 , 544	566 , 547	138 , 551	258 , 554	381 , 557	409 , 560	586 , 563
551 , 544	5 , 548	141 , 551	262 , 554	439 , 557	445 , 560	18 , 564
555 , 544	15 , 548	200 , 551	292 , 554	451 , 557	468 , 560	89 , 564
570 , 544	43 , 548	212 , 551	297 , 554	453 , 557	567 , 560	197 , 564
9 , 545	64 , 548	219 , 551	343 , 554	457 , 557	23 , 561	299 , 564
92 , 545	86 , 548	247 , 551	361 , 554	517 , 557	60 , 561	373 , 564
107 , 545	124 , 548	254 , 551	429 , 554	549 , 557	98 , 561	377 , 564

* Coordinates of elements with value "1" in submatrix A (599 rows, 600 columns). The coordinates are represented as R, C where R=row and C=column.

Table 6.2-2 LDPC Submatrix A for Subframe 2 * (sheet 10 of 11)

R , C	R , C	R , C	R , C	R , C	R , C	R , C
431 , 564	392 , 567	435 , 570	45 , 574	167 , 577	406 , 580	364 , 583
448 , 564	459 , 567	551 , 570	117 , 574	174 , 577	422 , 580	420 , 583
493 , 564	462 , 567	563 , 570	147 , 574	223 , 577	438 , 580	522 , 583
519 , 564	547 , 567	3 , 571	210 , 574	255 , 577	456 , 580	525 , 583
531 , 564	554 , 567	50 , 571	230 , 574	310 , 577	489 , 580	537 , 583
534 , 564	575 , 567	59 , 571	248 , 574	367 , 577	505 , 580	578 , 583
540 , 564	94 , 568	137 , 571	304 , 574	429 , 577	514 , 580	10 , 584
567 , 564	115 , 568	179 , 571	311 , 574	433 , 577	562 , 580	73 , 584
598 , 564	132 , 568	200 , 571	332 , 574	452 , 577	589 , 580	114 , 584
2 , 565	153 , 568	249 , 571	376 , 574	483 , 577	75 , 581	221 , 584
31 , 565	217 , 568	251 , 571	379 , 574	488 , 577	77 , 581	240 , 584
83 , 565	241 , 568	294 , 571	390 , 574	509 , 577	205 , 581	293 , 584
91 , 565	252 , 568	314 , 571	396 , 574	25 , 578	250 , 581	344 , 584
134 , 565	254 , 568	371 , 571	407 , 574	49 , 578	275 , 581	415 , 584
165 , 565	292 , 568	397 , 571	581 , 574	70 , 578	285 , 581	421 , 584
225 , 565	303 , 568	427 , 571	51 , 575	104 , 578	359 , 581	424 , 584
272 , 565	307 , 568	450 , 571	88 , 575	140 , 578	380 , 581	446 , 584
305 , 565	360 , 568	511 , 571	123 , 575	155 , 578	418 , 581	457 , 584
335 , 565	412 , 568	19 , 572	146 , 575	160 , 578	430 , 581	495 , 584
375 , 565	453 , 568	81 , 572	189 , 575	194 , 578	472 , 581	516 , 584
382 , 565	501 , 568	92 , 572	228 , 575	209 , 578	490 , 581	539 , 584
424 , 565	15 , 569	96 , 572	351 , 575	287 , 578	533 , 581	6 , 585
505 , 565	48 , 569	99 , 572	399 , 575	313 , 578	541 , 581	34 , 585
537 , 565	69 , 569	116 , 572	426 , 575	322 , 578	591 , 581	83 , 585
41 , 566	166 , 569	139 , 572	437 , 575	419 , 578	27 , 582	144 , 585
112 , 566	218 , 569	151 , 572	477 , 575	434 , 578	64 , 582	156 , 585
257 , 566	227 , 569	350 , 572	518 , 575	463 , 578	74 , 582	180 , 585
260 , 566	267 , 569	485 , 572	528 , 575	44 , 579	80 , 582	242 , 585
263 , 566	353 , 569	510 , 572	536 , 575	103 , 579	97 , 582	296 , 585
278 , 566	388 , 569	515 , 572	588 , 575	106 , 579	161 , 582	330 , 585
281 , 566	416 , 569	543 , 572	1 , 576	108 , 579	309 , 582	334 , 585
387 , 566	451 , 569	590 , 572	65 , 576	138 , 579	318 , 582	352 , 585
417 , 566	461 , 569	599 , 572	123 , 576	170 , 579	443 , 582	381 , 585
454 , 566	499 , 569	5 , 573	163 , 576	185 , 579	445 , 582	393 , 585
469 , 566	512 , 569	46 , 573	211 , 576	192 , 579	480 , 582	479 , 585
484 , 566	557 , 569	130 , 573	216 , 576	198 , 579	482 , 582	481 , 585
487 , 566	13 , 570	191 , 573	258 , 576	291 , 579	517 , 582	12 , 586
552 , 566	40 , 570	234 , 573	270 , 576	315 , 579	532 , 582	76 , 586
566 , 566	56 , 570	347 , 573	282 , 576	378 , 579	545 , 582	107 , 586
11 , 567	127 , 570	354 , 573	306 , 576	508 , 579	7 , 583	109 , 586
37 , 567	136 , 570	369 , 573	408 , 576	529 , 579	87 , 583	125 , 586
128 , 567	149 , 570	404 , 573	476 , 576	555 , 579	131 , 583	222 , 586
165 , 567	203 , 570	410 , 573	564 , 576	53 , 580	158 , 583	224 , 586
199 , 567	259 , 570	550 , 573	577 , 576	119 , 580	164 , 583	233 , 586
202 , 567	295 , 570	560 , 573	593 , 576	145 , 580	171 , 583	245 , 586
288 , 567	365 , 570	580 , 573	52 , 577	182 , 580	236 , 583	329 , 586
348 , 567	398 , 570	582 , 573	93 , 577	219 , 580	290 , 583	358 , 586
385 , 567	411 , 570	594 , 573	120 , 577	317 , 580	324 , 583	391 , 586

* Coordinates of elements with value "1" in submatrix A (599 rows, 600 columns). The coordinates are represented as R, C where R=row and C=column.

Table 6.2-2 LDPC Submatrix A for Subframe 2 * (sheet 11 of 11)

R , C	R , C	R , C	R , C	R , C	R , C	R , C
403 , 586	526 , 588	474 , 590	43 , 593	54 , 595	33 , 597	95 , 599
432 , 586	559 , 588	20 , 591	55 , 593	84 , 595	62 , 597	126 , 599
475 , 586	9 , 589	133 , 591	71 , 593	237 , 595	79 , 597	157 , 599
47 , 587	24 , 589	152 , 591	100 , 593	244 , 595	102 , 597	181 , 599
111 , 587	42 , 589	186 , 591	225 , 593	289 , 595	169 , 597	184 , 599
121 , 587	168 , 589	190 , 591	232 , 593	302 , 595	204 , 597	188 , 599
150 , 587	196 , 589	212 , 591	253 , 593	327 , 595	226 , 597	220 , 599
231 , 587	213 , 589	214 , 591	274 , 593	343 , 595	262 , 597	264 , 599
238 , 587	268 , 589	243 , 591	308 , 593	382 , 595	266 , 597	298 , 599
338 , 587	271 , 589	277 , 591	339 , 593	389 , 595	386 , 597	405 , 599
370 , 587	326 , 589	328 , 591	441 , 593	401 , 595	414 , 597	409 , 599
383 , 587	361 , 589	425 , 591	486 , 593	464 , 595	520 , 597	597 , 599
413 , 587	372 , 589	428 , 591	498 , 593	466 , 595	579 , 597	22 , 600
470 , 587	497 , 589	494 , 591	506 , 593	558 , 595	14 , 598	36 , 600
503 , 587	544 , 589	530 , 591	572 , 593	2 , 596	39 , 598	57 , 600
521 , 587	576 , 589	574 , 591	26 , 594	68 , 596	72 , 598	90 , 600
535 , 587	592 , 589	30 , 592	61 , 594	86 , 596	78 , 598	93 , 600
548 , 587	17 , 590	142 , 592	101 , 594	141 , 596	135 , 598	154 , 600
66 , 588	21 , 590	206 , 592	113 , 594	175 , 596	195 , 598	234 , 600
82 , 588	85 , 590	235 , 592	134 , 594	178 , 596	261 , 598	297 , 600
187 , 588	118 , 590	325 , 592	143 , 594	183 , 596	276 , 598	305 , 600
286 , 588	122 , 590	342 , 592	177 , 594	283 , 596	299 , 598	337 , 600
321 , 588	129 , 590	356 , 592	273 , 594	300 , 596	320 , 598	340 , 600
323 , 588	193 , 590	366 , 592	301 , 594	460 , 596	346 , 598	368 , 600
349 , 588	208 , 590	384 , 592	319 , 594	507 , 596	439 , 598	442 , 600
394 , 588	246 , 590	423 , 592	333 , 594	527 , 596	492 , 598	542 , 600
465 , 588	341 , 590	449 , 592	374 , 594	570 , 596	569 , 598	556 , 600
471 , 588	355 , 590	496 , 592	458 , 594	571 , 596	595 , 598	
502 , 588	395 , 590	500 , 592	473 , 594	585 , 596	16 , 599	
513 , 588	440 , 590	568 , 592	491 , 594	29 , 597	58 , 599	
524 , 588	455 , 590	583 , 592	32 , 595	31 , 597	91 , 599	

* Coordinates of elements with value “1” in submatrix A (599 rows, 600 columns). The coordinates are represented as R, C where R=row and C=column.

Table 6.2-3. LDPC Submatrix B for Subframe 2 *

R , C	R , C	R , C	R , C	R , C	R , C	R , C
1 , 1	110 , 1	178 , 1	229 , 1	269 , 1	423 , 1	532 , 1
44 , 1	155 , 1	205 , 1	263 , 1	335 , 1	510 , 1	597 , 1

* Coordinates of elements with value “1” in submatrix B (599 rows, 1 column). The coordinates are represented as R, C where R=row and C=column.

Table 6.2-4. LDPC Submatrix C for Subframe 2 *

R , C	R , C	R , C	R , C	R , C
1 , 74	1 , 322	1 , 402	1 , 485	1 , 527

* Coordinates of elements with value “1” in submatrix C (1 row, 600 columns). The coordinates are represented as R, C where R=row and C=column.

Table 6.2-5. LDPC Submatrix D for Subframe 2 *

R , C
1 , 1

* Coordinates of elements with value “1” in submatrix D (1 row, 1 column). The coordinates are represented as R, C where R=row and C=column.

Submatrix D is an “one” matrix.

Table 6.2-6. LDPC Submatrix E for Subframe 2 *

R , C	R , C
1 , 598	1 , 599

* Coordinates of elements with value “1” in submatrix E (1 row, 599 columns). The coordinates are represented as R, C where R=row and C=column.

Table 6.2-7. LDPC Submatrix T for Subframe 2 * (sheet 1 of 4)

R , C	R , C	R , C	R , C	R , C	R , C	R , C
1 , 1	24 , 24	47 , 46	69 , 69	93 , 92	116 , 116	140 , 140
2 , 1	25 , 24	47 , 47	70 , 69	93 , 93	117 , 116	141 , 140
2 , 2	25 , 25	48 , 47	70 , 70	94 , 93	117 , 117	141 , 141
3 , 2	26 , 25	48 , 48	71 , 70	94 , 94	118 , 117	142 , 141
263 , 2	26 , 26	49 , 48	71 , 71	95 , 94	118 , 118	142 , 142
3 , 3	27 , 26	49 , 49	72 , 71	95 , 95	119 , 118	143 , 142
4 , 3	77 , 26	50 , 49	72 , 72	96 , 95	119 , 119	143 , 143
4 , 4	27 , 27	50 , 50	73 , 72	96 , 96	120 , 119	144 , 143
5 , 4	28 , 27	51 , 50	73 , 73	97 , 96	120 , 120	144 , 144
5 , 5	28 , 28	209 , 50	74 , 73	97 , 97	121 , 120	145 , 144
6 , 5	29 , 28	51 , 51	74 , 74	98 , 97	121 , 121	145 , 145
6 , 6	29 , 29	52 , 51	75 , 74	98 , 98	122 , 121	146 , 145
7 , 6	30 , 29	52 , 52	75 , 75	159 , 98	122 , 122	146 , 146
35 , 6	30 , 30	53 , 52	76 , 75	577 , 98	123 , 122	147 , 146
7 , 7	31 , 30	572 , 52	76 , 76	99 , 99	123 , 123	211 , 146
8 , 7	31 , 31	53 , 53	99 , 76	100 , 99	124 , 123	147 , 147
8 , 8	32 , 31	54 , 53	415 , 76	100 , 100	124 , 124	148 , 147
9 , 8	32 , 32	54 , 54	77 , 77	101 , 100	125 , 124	148 , 148
9 , 9	33 , 32	55 , 54	78 , 77	101 , 101	125 , 125	149 , 148
10 , 9	475 , 32	191 , 54	78 , 78	102 , 101	126 , 125	163 , 148
10 , 10	33 , 33	55 , 55	79 , 78	102 , 102	126 , 126	149 , 149
11 , 10	34 , 33	56 , 55	79 , 79	103 , 102	127 , 126	150 , 149
11 , 11	34 , 34	56 , 56	80 , 79	103 , 103	127 , 127	150 , 150
12 , 11	119 , 34	57 , 56	80 , 80	104 , 103	128 , 127	151 , 150
12 , 12	232 , 34	57 , 57	81 , 80	104 , 104	128 , 128	151 , 151
13 , 12	35 , 35	58 , 57	81 , 81	105 , 104	129 , 128	152 , 151
13 , 13	36 , 35	58 , 58	82 , 81	105 , 105	129 , 129	152 , 152
14 , 13	36 , 36	59 , 58	82 , 82	106 , 105	130 , 129	153 , 152
14 , 14	37 , 36	59 , 59	83 , 82	106 , 106	130 , 130	153 , 153
15 , 14	37 , 37	60 , 59	83 , 83	107 , 106	131 , 130	154 , 153
15 , 15	38 , 37	60 , 60	84 , 83	107 , 107	131 , 131	154 , 154
16 , 15	38 , 38	61 , 60	84 , 84	108 , 107	132 , 131	155 , 154
16 , 16	39 , 38	61 , 61	85 , 84	108 , 108	132 , 132	155 , 155
17 , 16	39 , 39	62 , 61	85 , 85	109 , 108	133 , 132	156 , 155
17 , 17	40 , 39	62 , 62	86 , 85	109 , 109	133 , 133	156 , 156
18 , 17	40 , 40	63 , 62	86 , 86	110 , 109	134 , 133	157 , 156
18 , 18	41 , 40	63 , 63	87 , 86	110 , 110	134 , 134	157 , 157
19 , 18	41 , 41	64 , 63	87 , 87	111 , 110	135 , 134	158 , 157
19 , 19	42 , 41	64 , 64	88 , 87	111 , 111	135 , 135	158 , 158
20 , 19	42 , 42	65 , 64	88 , 88	112 , 111	136 , 135	161 , 158
20 , 20	43 , 42	65 , 65	89 , 88	112 , 112	136 , 136	159 , 159
21 , 20	43 , 43	66 , 65	89 , 89	113 , 112	137 , 136	160 , 159
21 , 21	44 , 43	66 , 66	90 , 89	113 , 113	137 , 137	160 , 160
22 , 21	44 , 44	67 , 66	90 , 90	114 , 113	138 , 137	162 , 160
22 , 22	45 , 44	67 , 67	91 , 90	114 , 114	138 , 138	161 , 161
23 , 22	45 , 45	68 , 67	91 , 91	115 , 114	139 , 138	162 , 161
23 , 23	46 , 45	68 , 68	92 , 91	115 , 115	139 , 139	162 , 162
24 , 23	46 , 46	69 , 68	92 , 92	116 , 115	140 , 139	289 , 162

* Coordinates of elements with value “1” in submatrix T (599 rows, 599 columns). The coordinates are represented as R, C where R=row and C=column.

Table 6.2-7. LDPC Submatrix T for Subframe 2 * (sheet 2 of 4)

R , C	R , C	R , C	R , C	R , C	R , C	R , C
361 , 162	186 , 185	209 , 209	233 , 232	257 , 256	281 , 280	305 , 304
163 , 163	186 , 186	210 , 209	233 , 233	257 , 257	281 , 281	305 , 304
164 , 163	187 , 186	210 , 210	234 , 233	258 , 257	282 , 281	305 , 305
164 , 164	187 , 187	244 , 210	234 , 234	258 , 258	282 , 282	306 , 305
165 , 164	188 , 187	447 , 210	235 , 234	259 , 258	283 , 282	306 , 306
165 , 165	188 , 188	211 , 211	235 , 235	259 , 259	283 , 283	307 , 306
166 , 165	189 , 188	212 , 211	236 , 235	260 , 259	284 , 283	307 , 307
166 , 166	189 , 189	212 , 212	236 , 236	260 , 260	284 , 284	308 , 307
167 , 166	190 , 189	213 , 212	237 , 236	261 , 260	285 , 284	308 , 308
167 , 167	190 , 190	213 , 213	237 , 237	261 , 261	285 , 285	309 , 308
168 , 167	201 , 190	214 , 213	238 , 237	262 , 261	286 , 285	309 , 309
168 , 168	191 , 191	214 , 214	238 , 238	262 , 262	286 , 286	310 , 309
169 , 168	192 , 191	215 , 214	239 , 238	289 , 262	287 , 286	310 , 310
169 , 169	192 , 192	215 , 215	239 , 239	263 , 263	287 , 287	311 , 310
170 , 169	193 , 192	216 , 215	240 , 239	264 , 263	288 , 287	311 , 311
170 , 170	193 , 193	216 , 216	240 , 240	264 , 264	288 , 288	312 , 311
171 , 170	194 , 193	217 , 216	241 , 240	265 , 264	304 , 288	312 , 312
171 , 171	194 , 194	217 , 217	241 , 241	265 , 265	289 , 289	313 , 312
172 , 171	195 , 194	218 , 217	242 , 241	266 , 265	290 , 289	313 , 313
172 , 172	195 , 195	218 , 218	242 , 242	266 , 266	290 , 290	314 , 313
173 , 172	196 , 195	219 , 218	243 , 242	267 , 266	291 , 290	314 , 314
467 , 172	196 , 196	219 , 219	243 , 243	267 , 267	291 , 291	315 , 314
173 , 173	197 , 196	220 , 219	244 , 243	268 , 267	292 , 291	323 , 314
174 , 173	197 , 197	220 , 220	244 , 244	268 , 268	292 , 292	315 , 315
174 , 174	198 , 197	221 , 220	245 , 244	269 , 268	293 , 292	316 , 315
175 , 174	198 , 198	221 , 221	245 , 245	269 , 269	293 , 293	316 , 316
175 , 175	199 , 198	222 , 221	246 , 245	270 , 269	294 , 293	317 , 316
176 , 175	199 , 199	222 , 222	246 , 246	270 , 270	294 , 294	317 , 317
176 , 176	200 , 199	223 , 222	247 , 246	271 , 270	295 , 294	318 , 317
177 , 176	200 , 200	223 , 223	247 , 247	271 , 271	295 , 295	318 , 318
331 , 176	205 , 200	224 , 223	248 , 247	272 , 271	296 , 295	319 , 318
177 , 177	201 , 201	224 , 224	248 , 248	272 , 272	296 , 296	423 , 318
178 , 177	202 , 201	225 , 224	249 , 248	273 , 272	297 , 296	319 , 319
178 , 178	202 , 202	225 , 225	249 , 249	273 , 273	297 , 297	320 , 319
179 , 178	203 , 202	226 , 225	250 , 249	274 , 273	298 , 297	320 , 320
179 , 179	203 , 203	226 , 226	250 , 250	274 , 274	298 , 298	321 , 320
180 , 179	204 , 203	227 , 226	251 , 250	275 , 274	299 , 298	321 , 321
180 , 180	204 , 204	227 , 227	251 , 251	275 , 275	299 , 299	322 , 321
181 , 180	208 , 204	228 , 227	252 , 251	276 , 275	300 , 299	322 , 322
181 , 181	205 , 205	228 , 228	252 , 252	276 , 276	300 , 300	392 , 322
182 , 181	206 , 205	229 , 228	253 , 252	277 , 276	301 , 300	594 , 322
182 , 182	206 , 206	229 , 229	253 , 253	277 , 277	301 , 301	323 , 323
183 , 182	207 , 206	230 , 229	254 , 253	278 , 277	302 , 301	324 , 323
183 , 183	207 , 207	230 , 230	254 , 254	278 , 278	302 , 302	324 , 324
184 , 183	208 , 207	231 , 230	255 , 254	279 , 278	303 , 302	325 , 324
184 , 184	208 , 208	231 , 231	255 , 255	279 , 279	303 , 303	325 , 325
185 , 184	269 , 208	232 , 231	256 , 255	280 , 279	304 , 303	326 , 325
185 , 185	498 , 208	232 , 232	256 , 256	280 , 280	304 , 304	326 , 326

* Coordinates of elements with value “1” in submatrix T (599 rows, 599 columns). The coordinates are represented as R, C where R=row and C=column.

Table 6.2-7. LDPC Submatrix T for Subframe 2 * (sheet 3 of 4)

R , C	R , C	R , C	R , C	R , C	R , C	R , C
327 , 326	350 , 350	374 , 373	397 , 397	421 , 421	445 , 445	469 , 468
327 , 327	351 , 350	374 , 374	398 , 397	422 , 421	446 , 445	469 , 469
328 , 327	351 , 351	375 , 374	398 , 398	422 , 422	446 , 446	470 , 469
328 , 328	352 , 351	375 , 375	399 , 398	439 , 422	484 , 446	470 , 470
329 , 328	352 , 352	376 , 375	399 , 399	423 , 423	515 , 446	472 , 470
329 , 329	353 , 352	376 , 376	400 , 399	424 , 423	447 , 447	471 , 471
330 , 329	353 , 353	377 , 376	400 , 400	424 , 424	448 , 447	472 , 471
330 , 330	354 , 353	377 , 377	401 , 400	425 , 424	448 , 448	472 , 472
346 , 330	354 , 354	378 , 377	401 , 401	425 , 425	449 , 448	487 , 472
478 , 330	355 , 354	378 , 378	402 , 401	426 , 425	449 , 449	545 , 472
331 , 331	355 , 355	379 , 378	402 , 402	426 , 426	450 , 449	473 , 473
332 , 331	356 , 355	379 , 379	403 , 402	427 , 426	450 , 450	474 , 473
332 , 332	356 , 356	380 , 379	403 , 403	427 , 427	451 , 450	474 , 474
333 , 332	357 , 356	380 , 380	404 , 403	428 , 427	451 , 451	507 , 474
333 , 333	357 , 357	381 , 380	404 , 404	428 , 428	452 , 451	475 , 475
334 , 333	358 , 357	381 , 381	405 , 404	429 , 428	452 , 452	476 , 475
334 , 334	358 , 358	382 , 381	405 , 405	429 , 429	453 , 452	476 , 476
335 , 334	359 , 358	382 , 382	406 , 405	430 , 429	453 , 453	477 , 476
335 , 335	359 , 359	383 , 382	406 , 406	430 , 430	454 , 453	477 , 477
336 , 335	360 , 359	383 , 383	407 , 406	431 , 430	454 , 454	478 , 477
336 , 336	360 , 360	384 , 383	407 , 407	431 , 431	455 , 454	478 , 478
337 , 336	361 , 360	384 , 384	408 , 407	432 , 431	455 , 455	479 , 478
337 , 337	361 , 361	385 , 384	408 , 408	432 , 432	456 , 455	479 , 479
338 , 337	362 , 361	473 , 384	409 , 408	433 , 432	456 , 456	480 , 479
338 , 338	362 , 362	385 , 385	409 , 409	433 , 433	457 , 456	480 , 480
339 , 338	363 , 362	386 , 385	410 , 409	434 , 433	457 , 457	481 , 480
339 , 339	363 , 363	386 , 386	410 , 410	434 , 434	458 , 457	481 , 481
340 , 339	364 , 363	387 , 386	411 , 410	435 , 434	458 , 458	482 , 481
340 , 340	364 , 364	387 , 387	411 , 411	435 , 435	459 , 458	482 , 482
341 , 340	365 , 364	388 , 387	412 , 411	436 , 435	459 , 459	483 , 482
341 , 341	513 , 364	388 , 388	412 , 412	436 , 436	460 , 459	483 , 483
342 , 341	365 , 365	389 , 388	413 , 412	437 , 436	460 , 460	484 , 483
342 , 342	366 , 365	389 , 389	413 , 413	437 , 437	461 , 460	484 , 484
343 , 342	366 , 366	390 , 389	414 , 413	438 , 437	461 , 461	485 , 484
343 , 343	367 , 366	390 , 390	414 , 414	438 , 438	462 , 461	485 , 485
344 , 343	367 , 367	391 , 390	415 , 414	443 , 438	462 , 462	486 , 485
344 , 344	368 , 367	391 , 391	415 , 415	439 , 439	463 , 462	486 , 486
345 , 344	368 , 368	392 , 391	416 , 415	440 , 439	463 , 463	487 , 486
345 , 345	369 , 368	392 , 392	416 , 416	440 , 440	464 , 463	487 , 487
346 , 345	369 , 369	393 , 392	417 , 416	441 , 440	464 , 464	488 , 487
346 , 346	370 , 369	393 , 393	417 , 417	441 , 441	465 , 464	488 , 488
347 , 346	370 , 370	394 , 393	418 , 417	442 , 441	465 , 465	489 , 488
347 , 347	371 , 370	394 , 394	418 , 418	442 , 442	466 , 465	489 , 489
348 , 347	371 , 371	395 , 394	419 , 418	445 , 442	466 , 466	490 , 489
348 , 348	372 , 371	395 , 395	419 , 419	443 , 443	471 , 466	490 , 490
349 , 348	372 , 372	396 , 395	420 , 419	444 , 443	467 , 467	491 , 490
349 , 349	373 , 372	396 , 396	420 , 420	444 , 444	468 , 467	491 , 491
350 , 349	373 , 373	397 , 396	421 , 420	446 , 444	468 , 468	492 , 491

* Coordinates of elements with value “1” in submatrix T (599 rows, 599 columns). The coordinates are represented as R, C where R=row and C=column.

Table 6.2-7. LDPC Submatrix T for Subframe 2 * (sheet 4 of 4)

R , C	R , C	R , C	R , C	R , C	R , C	R , C
492 , 492	508 , 507	523 , 522	538 , 538	554 , 553	569 , 569	585 , 584
493 , 492	508 , 508	523 , 523	539 , 538	554 , 554	570 , 569	585 , 585
493 , 493	509 , 508	524 , 523	539 , 539	555 , 554	570 , 570	586 , 585
494 , 493	509 , 509	524 , 524	540 , 539	555 , 555	577 , 570	586 , 586
494 , 494	510 , 509	525 , 524	540 , 540	556 , 555	571 , 571	587 , 586
495 , 494	510 , 510	525 , 525	541 , 540	556 , 556	572 , 571	587 , 587
495 , 495	512 , 510	526 , 525	541 , 541	557 , 556	572 , 572	588 , 587
496 , 495	511 , 511	526 , 526	542 , 541	557 , 557	573 , 572	588 , 588
496 , 496	512 , 511	527 , 526	542 , 542	558 , 557	573 , 573	595 , 588
497 , 496	512 , 512	527 , 527	543 , 542	558 , 558	574 , 573	589 , 589
497 , 497	542 , 512	528 , 527	543 , 543	559 , 558	574 , 574	590 , 589
498 , 497	581 , 512	528 , 528	544 , 543	559 , 559	575 , 574	590 , 590
498 , 498	513 , 513	529 , 528	544 , 544	560 , 559	575 , 575	591 , 590
499 , 498	514 , 513	529 , 529	545 , 544	560 , 560	576 , 575	591 , 591
499 , 499	514 , 514	530 , 529	545 , 545	561 , 560	576 , 576	592 , 591
500 , 499	515 , 514	530 , 530	546 , 545	561 , 561	589 , 576	592 , 592
500 , 500	515 , 515	531 , 530	546 , 546	562 , 561	577 , 577	593 , 592
501 , 500	516 , 515	531 , 531	547 , 546	562 , 562	578 , 577	593 , 593
501 , 501	516 , 516	532 , 531	547 , 547	563 , 562	578 , 578	594 , 593
502 , 501	517 , 516	532 , 532	548 , 547	563 , 563	579 , 578	594 , 594
502 , 502	517 , 517	571 , 532	548 , 548	564 , 563	579 , 579	597 , 594
503 , 502	518 , 517	533 , 533	549 , 548	564 , 564	580 , 579	595 , 595
503 , 503	518 , 518	534 , 533	549 , 549	565 , 564	580 , 580	596 , 595
504 , 503	519 , 518	534 , 534	550 , 549	565 , 565	581 , 580	596 , 596
504 , 504	519 , 519	535 , 534	550 , 550	566 , 565	581 , 581	598 , 596
505 , 504	520 , 519	535 , 535	551 , 550	566 , 566	582 , 581	597 , 597
505 , 505	520 , 520	536 , 535	551 , 551	567 , 566	582 , 582	599 , 597
506 , 505	521 , 520	536 , 536	552 , 551	567 , 567	583 , 582	598 , 598
506 , 506	521 , 521	537 , 536	552 , 552	568 , 567	583 , 583	599 , 599
511 , 506	522 , 521	537 , 537	553 , 552	568 , 568	584 , 583	
507 , 507	522 , 522	538 , 537	553 , 553	569 , 568	584 , 584	

* Coordinates of elements with value “1” in submatrix T (599 rows, 599 columns). The coordinates are represented as R, C where R=row and C=column.

Table 6.2-8. LDPC Submatrix A for Subframe 3 * (sheet 1 of 5)

R , C	R , C	R , C	R , C	R , C	R , C	R , C
1 , 1	41 , 17	112 , 33	142 , 49	149 , 65	219 , 81	222 , 97
17 , 1	118 , 17	179 , 33	145 , 49	216 , 65	225 , 81	20 , 98
231 , 1	161 , 17	74 , 34	36 , 50	61 , 66	15 , 82	147 , 98
82 , 2	48 , 18	158 , 34	252 , 50	200 , 66	97 , 82	224 , 98
109 , 2	70 , 18	260 , 34	268 , 50	238 , 66	101 , 82	58 , 99
261 , 2	198 , 18	53 , 35	77 , 51	31 , 67	108 , 83	199 , 99
7 , 3	87 , 19	94 , 35	133 , 51	68 , 67	224 , 83	218 , 99
46 , 3	107 , 19	127 , 35	195 , 51	170 , 67	243 , 83	133 , 100
83 , 3	174 , 19	14 , 36	105 , 52	43 , 68	140 , 84	156 , 100
141 , 4	32 , 20	65 , 36	159 , 52	96 , 68	203 , 84	251 , 100
173 , 4	165 , 20	85 , 36	258 , 52	220 , 68	239 , 84	91 , 101
269 , 4	244 , 20	22 , 37	8 , 53	84 , 69	37 , 85	223 , 101
28 , 5	1 , 21	44 , 37	29 , 53	191 , 69	158 , 85	266 , 101
59 , 5	137 , 21	241 , 37	89 , 53	273 , 69	212 , 85	65 , 102
152 , 5	219 , 21	116 , 38	2 , 54	93 , 70	27 , 86	205 , 102
64 , 6	169 , 22	143 , 38	39 , 54	140 , 70	50 , 86	221 , 102
147 , 6	210 , 22	255 , 38	98 , 54	151 , 70	5 , 87	60 , 103
181 , 6	239 , 22	108 , 39	24 , 55	35 , 71	16 , 87	167 , 103
58 , 7	11 , 23	131 , 39	132 , 55	78 , 71	163 , 87	252 , 103
114 , 7	215 , 23	234 , 39	202 , 55	111 , 71	180 , 88	56 , 104
211 , 7	148 , 24	10 , 40	19 , 56	79 , 72	231 , 88	164 , 104
13 , 8	201 , 24	113 , 40	206 , 56	129 , 72	258 , 88	249 , 104
156 , 8	259 , 24	222 , 40	250 , 56	246 , 72	42 , 89	25 , 105
177 , 8	90 , 25	30 , 41	124 , 57	63 , 73	76 , 89	35 , 105
38 , 9	199 , 25	42 , 41	136 , 57	189 , 73	168 , 89	256 , 105
52 , 9	228 , 25	272 , 41	170 , 57	233 , 73	100 , 90	14 , 106
223 , 9	21 , 26	4 , 42	27 , 58	5 , 74	104 , 90	184 , 106
18 , 10	157 , 26	128 , 42	99 , 58	122 , 74	113 , 90	247 , 106
60 , 10	171 , 26	168 , 42	172 , 58	178 , 74	82 , 91	162 , 107
86 , 10	6 , 27	20 , 43	12 , 59	17 , 75	124 , 91	227 , 107
120 , 11	245 , 27	117 , 43	119 , 59	88 , 75	206 , 91	242 , 107
175 , 11	267 , 27	197 , 43	232 , 59	187 , 75	24 , 92	157 , 108
249 , 11	121 , 28	66 , 44	9 , 60	47 , 76	83 , 92	215 , 108
49 , 12	134 , 28	75 , 44	146 , 60	164 , 76	118 , 92	265 , 108
139 , 12	150 , 28	115 , 44	248 , 60	212 , 76	54 , 93	87 , 109
184 , 12	240 , 29	126 , 45	110 , 61	106 , 77	225 , 93	154 , 109
25 , 13	251 , 29	207 , 45	167 , 61	138 , 77	269 , 93	213 , 109
67 , 13	271 , 29	218 , 45	230 , 61	227 , 77	40 , 94	86 , 110
265 , 13	71 , 30	102 , 46	51 , 62	55 , 78	152 , 94	182 , 110
56 , 14	180 , 30	214 , 46	72 , 62	135 , 78	181 , 94	270 , 110
103 , 14	192 , 30	246 , 46	209 , 62	264 , 78	62 , 95	41 , 111
204 , 14	40 , 31	45 , 47	3 , 63	144 , 79	98 , 95	210 , 111
162 , 15	183 , 31	54 , 47	33 , 63	165 , 79	234 , 95	267 , 111
193 , 15	263 , 31	194 , 47	57 , 63	254 , 79	32 , 96	66 , 112
205 , 15	26 , 32	91 , 48	34 , 64	123 , 80	172 , 96	174 , 112
95 , 16	80 , 32	176 , 48	185 , 64	150 , 80	262 , 96	230 , 112
182 , 16	163 , 32	190 , 48	236 , 64	188 , 80	48 , 97	94 , 113
213 , 16	23 , 33	81 , 49	69 , 65	155 , 81	153 , 97	112 , 113

* Coordinates of elements with value "1" in submatrix A (273 rows, 274 columns). The coordinates are represented as R, C where R=row and C=column.

Table 6.2-8. LDPC Submatrix A for Subframe 3 * (sheet 2 of 5)

R , C	R , C	R , C	R , C	R , C	R , C	R , C
244 , 113	211 , 129	176 , 145	177 , 161	226 , 177	250 , 189	173 , 196
171 , 114	178 , 130	122 , 146	99 , 162	100 , 178	108 , 190	235 , 196
204 , 114	189 , 130	142 , 146	110 , 162	133 , 178	145 , 190	17 , 197
255 , 114	201 , 130	228 , 146	187 , 162	140 , 178	221 , 190	44 , 197
229 , 115	53 , 131	9 , 147	57 , 163	260 , 178	271 , 190	76 , 197
235 , 115	120 , 131	131 , 147	139 , 163	51 , 179	21 , 191	95 , 197
250 , 115	273 , 131	268 , 147	233 , 163	82 , 179	47 , 191	165 , 197
137 , 116	198 , 132	49 , 148	76 , 164	112 , 179	60 , 191	177 , 197
175 , 116	241 , 132	123 , 148	238 , 164	189 , 179	196 , 191	205 , 197
259 , 116	248 , 132	237 , 148	257 , 164	83 , 180	142 , 192	210 , 197
129 , 117	38 , 133	96 , 149	12 , 165	146 , 180	160 , 192	217 , 197
141 , 117	143 , 133	117 , 149	51 , 165	172 , 180	214 , 192	246 , 197
148 , 117	240 , 133	195 , 149	220 , 165	238 , 180	249 , 192	264 , 197
44 , 118	10 , 134	26 , 150	85 , 166	4 , 181	48 , 193	28 , 198
59 , 118	19 , 134	61 , 150	125 , 166	123 , 181	81 , 193	41 , 198
81 , 118	263 , 134	134 , 150	135 , 166	241 , 181	182 , 193	49 , 198
90 , 119	3 , 135	8 , 151	69 , 167	269 , 181	256 , 193	68 , 198
101 , 119	46 , 135	39 , 151	95 , 167	53 , 182	27 , 194	84 , 198
264 , 119	216 , 135	77 , 151	138 , 167	90 , 182	54 , 194	87 , 198
2 , 120	13 , 136	7 , 152	202 , 168	152 , 182	77 , 194	116 , 198
21 , 120	47 , 136	155 , 152	245 , 168	204 , 182	91 , 194	134 , 198
209 , 120	173 , 136	190 , 152	261 , 168	35 , 183	109 , 194	228 , 198
71 , 121	34 , 137	1 , 153	97 , 169	62 , 183	148 , 194	254 , 198
89 , 121	102 , 137	75 , 153	127 , 169	206 , 183	184 , 194	258 , 198
166 , 121	121 , 137	151 , 153	197 , 169	273 , 183	207 , 194	6 , 199
11 , 122	70 , 138	43 , 154	103 , 170	72 , 184	212 , 194	19 , 199
188 , 122	109 , 138	159 , 154	118 , 170	120 , 184	231 , 194	34 , 199
194 , 122	272 , 138	253 , 154	271 , 170	227 , 184	240 , 194	64 , 199
104 , 123	15 , 139	4 , 155	17 , 171	262 , 184	40 , 195	71 , 199
107 , 123	130 , 139	73 , 155	116 , 171	153 , 185	130 , 195	98 , 199
217 , 123	196 , 139	144 , 155	208 , 171	159 , 185	150 , 195	144 , 199
111 , 124	55 , 140	74 , 156	63 , 172	170 , 185	179 , 195	157 , 199
183 , 124	128 , 140	80 , 156	101 , 172	186 , 185	197 , 195	174 , 199
193 , 124	231 , 140	119 , 156	191 , 172	147 , 186	219 , 195	218 , 199
30 , 125	6 , 141	67 , 157	22 , 173	154 , 186	230 , 195	239 , 199
145 , 125	115 , 141	126 , 157	78 , 173	162 , 186	242 , 195	23 , 200
179 , 125	186 , 141	160 , 157	254 , 173	167 , 186	247 , 195	79 , 200
16 , 126	29 , 142	64 , 158	12 , 174	24 , 187	251 , 195	131 , 200
93 , 126	207 , 142	88 , 158	36 , 174	58 , 187	265 , 195	161 , 200
226 , 126	243 , 142	132 , 158	68 , 174	175 , 187	11 , 196	164 , 200
28 , 127	31 , 143	52 , 159	23 , 175	193 , 187	38 , 196	181 , 200
37 , 127	200 , 143	79 , 159	33 , 175	42 , 188	56 , 196	187 , 200
136 , 127	214 , 143	105 , 159	203 , 175	80 , 188	74 , 196	200 , 200
192 , 128	45 , 144	18 , 160	10 , 176	156 , 188	92 , 196	209 , 200
236 , 128	72 , 144	149 , 160	168 , 176	244 , 188	97 , 196	229 , 200
260 , 128	125 , 144	161 , 160	185 , 176	75 , 189	106 , 196	253 , 200
84 , 129	50 , 145	92 , 161	114 , 177	194 , 189	110 , 196	22 , 201
106 , 129	169 , 145	146 , 161	129 , 177	223 , 189	155 , 196	36 , 201

* Coordinates of elements with value “1” in submatrix A (273 rows, 274 columns). The coordinates are represented as R, C where R=row and C=column.

Table 6.2-8. LDPC Submatrix A for Subframe 3 * (sheet 3 of 5)

R , C	R , C	R , C	R , C	R , C	R , C	R , C
65 , 201	119 , 205	257 , 209	90 , 214	213 , 218	41 , 223	172 , 227
99 , 201	124 , 205	2 , 210	100 , 214	223 , 218	63 , 223	183 , 227
127 , 201	166 , 205	9 , 210	129 , 214	225 , 218	88 , 223	203 , 227
137 , 201	171 , 205	26 , 210	132 , 214	228 , 218	122 , 223	217 , 227
211 , 201	201 , 205	45 , 210	145 , 214	9 , 219	130 , 223	240 , 227
243 , 201	20 , 206	70 , 210	175 , 214	47 , 219	186 , 223	254 , 227
263 , 201	32 , 206	105 , 210	244 , 214	64 , 219	200 , 223	10 , 228
266 , 201	46 , 206	115 , 210	266 , 214	91 , 219	205 , 223	46 , 228
270 , 201	104 , 206	118 , 210	56 , 215	126 , 219	227 , 223	80 , 228
8 , 202	139 , 206	167 , 210	61 , 215	153 , 219	240 , 223	94 , 228
13 , 202	176 , 206	233 , 210	67 , 215	199 , 219	272 , 223	138 , 228
18 , 202	178 , 206	259 , 210	82 , 215	220 , 219	14 , 224	143 , 228
37 , 202	191 , 206	16 , 211	114 , 215	252 , 219	17 , 224	159 , 228
43 , 202	220 , 206	62 , 211	168 , 215	255 , 219	29 , 224	179 , 228
61 , 202	256 , 206	63 , 211	191 , 215	262 , 219	50 , 224	194 , 228
107 , 202	267 , 206	66 , 211	218 , 215	16 , 220	53 , 224	210 , 228
126 , 202	14 , 207	69 , 211	237 , 215	19 , 220	109 , 224	226 , 228
169 , 202	33 , 207	89 , 211	258 , 215	31 , 220	117 , 224	4 , 229
202 , 202	111 , 207	117 , 211	259 , 215	54 , 220	123 , 224	40 , 229
215 , 202	114 , 207	141 , 211	43 , 216	81 , 220	133 , 224	66 , 229
7 , 203	149 , 207	146 , 211	55 , 216	120 , 220	170 , 224	105 , 229
31 , 203	163 , 207	222 , 211	83 , 216	136 , 220	174 , 224	111 , 229
59 , 203	180 , 207	236 , 211	144 , 216	151 , 220	21 , 225	119 , 229
85 , 203	213 , 207	5 , 212	148 , 216	187 , 220	52 , 225	134 , 229
88 , 203	245 , 207	22 , 212	156 , 216	221 , 220	107 , 225	177 , 229
128 , 203	255 , 207	39 , 212	182 , 216	245 , 220	135 , 225	209 , 229
138 , 203	272 , 207	48 , 212	204 , 216	27 , 221	158 , 225	215 , 229
158 , 203	3 , 208	57 , 212	206 , 216	32 , 221	166 , 225	231 , 229
183 , 203	29 , 208	135 , 212	242 , 216	60 , 221	173 , 225	18 , 230
198 , 203	78 , 208	147 , 212	249 , 216	92 , 221	181 , 225	23 , 230
237 , 203	103 , 208	160 , 212	15 , 217	116 , 221	216 , 225	57 , 230
25 , 204	143 , 208	188 , 212	37 , 217	121 , 221	257 , 225	59 , 230
94 , 204	151 , 208	225 , 212	58 , 217	127 , 221	273 , 225	74 , 230
122 , 204	185 , 208	260 , 212	112 , 217	131 , 221	6 , 226	77 , 230
136 , 204	190 , 208	28 , 213	154 , 217	193 , 221	24 , 226	93 , 230
192 , 204	199 , 208	42 , 213	188 , 217	233 , 221	51 , 226	98 , 230
195 , 204	261 , 208	52 , 213	246 , 217	239 , 221	84 , 226	99 , 230
208 , 204	268 , 208	55 , 213	250 , 217	5 , 222	140 , 226	238 , 230
216 , 204	1 , 209	162 , 213	263 , 217	26 , 222	149 , 226	267 , 230
232 , 204	15 , 209	178 , 213	265 , 217	34 , 222	176 , 226	36 , 231
234 , 204	30 , 209	196 , 213	269 , 217	65 , 222	198 , 226	44 , 231
248 , 204	67 , 209	214 , 213	12 , 218	95 , 222	208 , 226	72 , 231
50 , 205	73 , 209	236 , 213	86 , 218	104 , 222	235 , 226	101 , 231
86 , 205	121 , 209	241 , 213	139 , 218	125 , 222	264 , 226	163 , 231
93 , 205	132 , 209	270 , 213	150 , 218	184 , 222	43 , 227	169 , 231
96 , 205	203 , 209	7 , 214	152 , 218	189 , 222	74 , 227	171 , 231
102 , 205	224 , 209	35 , 214	172 , 218	229 , 222	131 , 227	190 , 231
113 , 205	252 , 209	75 , 214	211 , 218	234 , 222	154 , 227	219 , 231

* Coordinates of elements with value “1” in submatrix A (273 rows, 274 columns). The coordinates are represented as R, C where R=row and C=column.

Table 6.2-8. LDPC Submatrix A for Subframe 3 * (sheet 4 of 5)

R , C	R , C	R , C	R , C	R , C	R , C	R , C
232 , 231	70 , 236	195 , 240	237 , 244	61 , 249	119 , 253	20 , 258
271 , 231	97 , 236	223 , 240	15 , 245	70 , 249	211 , 253	59 , 258
11 , 232	128 , 236	256 , 240	34 , 245	99 , 249	239 , 253	67 , 258
87 , 232	192 , 236	261 , 240	77 , 245	116 , 249	244 , 253	92 , 258
89 , 232	201 , 236	269 , 240	126 , 245	120 , 249	2 , 254	109 , 258
96 , 232	212 , 236	13 , 241	156 , 245	186 , 249	12 , 254	115 , 258
115 , 232	224 , 236	24 , 241	159 , 245	190 , 249	57 , 254	136 , 258
157 , 232	254 , 236	63 , 241	198 , 245	265 , 249	149 , 254	143 , 258
161 , 232	268 , 236	80 , 241	213 , 245	59 , 250	151 , 254	202 , 258
175 , 232	9 , 237	104 , 241	216 , 245	166 , 250	158 , 254	206 , 258
243 , 232	22 , 237	106 , 241	219 , 245	174 , 250	174 , 254	209 , 258
247 , 232	33 , 237	134 , 241	243 , 245	180 , 250	191 , 254	36 , 259
261 , 232	73 , 237	152 , 241	4 , 246	185 , 250	200 , 254	45 , 259
2 , 233	85 , 237	196 , 241	6 , 246	193 , 250	210 , 254	53 , 259
49 , 233	90 , 237	207 , 241	29 , 246	208 , 250	224 , 254	81 , 259
79 , 233	176 , 237	266 , 241	37 , 246	219 , 250	5 , 255	124 , 259
85 , 233	187 , 237	8 , 242	102 , 246	240 , 250	44 , 255	160 , 259
110 , 233	205 , 237	49 , 242	125 , 246	244 , 250	55 , 255	189 , 259
142 , 233	230 , 237	51 , 242	129 , 246	256 , 250	97 , 255	212 , 259
165 , 233	250 , 237	62 , 242	139 , 246	7 , 251	105 , 255	258 , 259
185 , 233	11 , 238	65 , 242	167 , 246	21 , 251	114 , 255	267 , 259
202 , 233	31 , 238	130 , 242	197 , 246	38 , 251	157 , 255	272 , 259
203 , 233	58 , 238	162 , 242	249 , 246	40 , 251	181 , 255	10 , 260
251 , 233	60 , 238	194 , 242	25 , 247	76 , 251	228 , 255	18 , 260
1 , 234	82 , 238	225 , 242	52 , 247	87 , 251	248 , 255	96 , 260
38 , 234	100 , 238	231 , 242	69 , 247	123 , 251	263 , 255	121 , 260
45 , 234	108 , 238	262 , 242	111 , 247	182 , 251	28 , 256	177 , 260
69 , 234	164 , 238	35 , 243	145 , 247	192 , 251	73 , 256	230 , 260
78 , 234	227 , 238	93 , 243	150 , 247	199 , 251	88 , 256	234 , 260
102 , 234	236 , 238	128 , 243	184 , 247	271 , 251	117 , 256	245 , 260
108 , 234	255 , 238	141 , 243	201 , 247	3 , 252	165 , 256	253 , 260
180 , 234	17 , 239	153 , 243	218 , 247	41 , 252	171 , 256	271 , 260
207 , 234	27 , 239	155 , 243	246 , 247	98 , 252	188 , 256	273 , 260
217 , 234	39 , 239	161 , 243	260 , 247	148 , 252	193 , 256	16 , 261
248 , 234	71 , 239	163 , 243	26 , 248	166 , 252	215 , 256	28 , 261
8 , 235	83 , 239	241 , 243	86 , 248	168 , 252	235 , 256	32 , 261
25 , 235	101 , 239	251 , 243	110 , 248	226 , 252	238 , 256	78 , 261
30 , 235	138 , 239	257 , 243	112 , 248	233 , 252	14 , 257	94 , 261
68 , 235	140 , 239	23 , 244	132 , 248	247 , 252	46 , 257	144 , 261
103 , 235	173 , 239	54 , 244	135 , 248	264 , 252	64 , 257	170 , 261
106 , 235	185 , 239	68 , 244	170 , 248	270 , 252	66 , 257	211 , 261
113 , 235	221 , 239	75 , 244	180 , 248	33 , 253	84 , 257	227 , 261
141 , 235	47 , 240	89 , 244	214 , 248	48 , 253	118 , 257	252 , 261
164 , 235	56 , 240	122 , 244	222 , 248	79 , 253	137 , 257	259 , 261
183 , 235	72 , 240	133 , 244	242 , 248	91 , 253	142 , 257	19 , 262
197 , 235	95 , 240	147 , 244	1 , 249	103 , 253	229 , 257	30 , 262
13 , 236	113 , 240	169 , 244	42 , 249	107 , 253	232 , 257	118 , 262
39 , 236	179 , 240	204 , 244	50 , 249	115 , 253	268 , 257	125 , 262

* Coordinates of elements with value "1" in submatrix A (273 rows, 274 columns). The coordinates are represented as R, C where R=row and C=column.

Table 6.2-8. LDPC Submatrix A for Subframe 3 * (sheet 5 of 5)

R , C	R , C	R , C	R , C	R , C	R , C	R , C
127 , 262	63 , 264	8 , 266	269 , 267	218 , 269	148 , 271	107 , 273
146 , 262	74 , 264	15 , 266	273 , 267	222 , 269	151 , 271	112 , 273
154 , 262	76 , 264	38 , 266	39 , 268	262 , 269	173 , 271	172 , 273
171 , 262	100 , 264	72 , 266	51 , 268	265 , 269	178 , 271	177 , 273
208 , 262	144 , 264	83 , 266	69 , 268	10 , 270	192 , 271	186 , 273
220 , 262	159 , 264	94 , 266	99 , 268	14 , 270	209 , 271	197 , 273
253 , 262	214 , 264	111 , 266	105 , 268	27 , 270	21 , 272	259 , 273
40 , 263	228 , 264	124 , 266	121 , 268	98 , 270	30 , 272	261 , 273
62 , 263	231 , 264	200 , 266	152 , 268	130 , 270	80 , 272	34 , 274
68 , 263	9 , 265	220 , 266	168 , 268	147 , 270	201 , 272	61 , 274
70 , 263	18 , 265	270 , 266	202 , 268	182 , 270	205 , 272	78 , 274
79 , 263	20 , 265	36 , 267	242 , 268	190 , 270	215 , 272	88 , 274
137 , 263	41 , 265	48 , 267	255 , 268	198 , 270	223 , 272	91 , 274
153 , 263	65 , 265	73 , 267	17 , 269	236 , 270	232 , 272	133 , 274
178 , 263	82 , 265	86 , 267	23 , 269	254 , 270	239 , 272	136 , 274
207 , 263	89 , 265	138 , 267	46 , 269	22 , 271	258 , 272	150 , 274
221 , 263	113 , 265	149 , 267	90 , 269	26 , 271	263 , 272	203 , 274
250 , 263	129 , 265	156 , 267	103 , 269	58 , 271	5 , 273	226 , 274
45 , 264	181 , 265	175 , 267	160 , 269	96 , 271	54 , 273	249 , 274
50 , 264	251 , 265	248 , 267	167 , 269	142 , 271	60 , 273	

* Coordinates of elements with value “1” in submatrix A (273 rows, 274 columns). The coordinates are represented as R, C where R=row and C=column.

Table 6.2-9. LDPC Submatrix B for Subframe 3 *

R , C	R , C	R , C	R , C	R , C
3 , 1	71 , 1	124 , 1	155 , 1	222 , 1
20 , 1	76 , 1	137 , 1	195 , 1	253 , 1

* Coordinates of elements with value “1” in submatrix B (273 rows, 1 column). The coordinates are represented as R, C where R=row and C=column.

Table 6.2-10. LDPC Submatrix C for Subframe 3 *

R , C	R , C	R , C	R , C
1 , 23	1 , 86	1 , 177	1 , 227

* Coordinates of elements with value “1” in submatrix C (1 row, 274 columns). The coordinates are represented as R, C where R=row and C=column.

Table 6.2-11. LDPC Submatrix D for Subframe 3 *

R , C
1 , 1

* Coordinates of elements with value “1” in submatrix D (1 row, 1 column). The coordinates are represented as R, C where R=row and C=column.

Submatrix D is a “one” matrix.

Table 6.2-12. LDPC Submatrix E for Subframe 3 *

R , C	R , C
1 , 271	1 , 273

* Coordinates of elements with value “1” in submatrix E (1 row, 273 columns). The coordinates are represented as R, C where R=row and C=column.

Table 6.2-13. LDPC Submatrix T for Subframe 3 * (sheet 1 of 2)

R , C	R , C	R , C	R , C	R , C	R , C	R , C
1 , 1	23 , 23	45 , 45	68 , 68	92 , 90	113 , 112	135 , 135
2 , 1	24 , 23	46 , 45	69 , 68	91 , 91	113 , 113	136 , 135
2 , 2	24 , 24	46 , 46	97 , 68	92 , 91	114 , 113	136 , 136
3 , 2	25 , 24	47 , 46	69 , 69	92 , 92	114 , 114	137 , 136
145 , 2	25 , 25	47 , 47	70 , 69	93 , 92	115 , 114	137 , 137
3 , 3	26 , 25	48 , 47	70 , 70	160 , 92	115 , 115	138 , 137
4 , 3	26 , 26	48 , 48	71 , 70	93 , 93	116 , 115	138 , 138
4 , 4	27 , 26	49 , 48	71 , 71	94 , 93	116 , 116	139 , 138
5 , 4	27 , 27	49 , 49	72 , 71	94 , 94	117 , 116	139 , 139
5 , 5	28 , 27	50 , 49	72 , 72	95 , 94	135 , 116	140 , 139
6 , 5	28 , 28	50 , 50	73 , 72	95 , 95	117 , 117	140 , 140
6 , 6	29 , 28	55 , 50	73 , 73	96 , 95	118 , 117	141 , 140
7 , 6	29 , 29	131 , 50	74 , 73	96 , 96	118 , 118	141 , 141
7 , 7	30 , 29	51 , 51	74 , 74	99 , 96	119 , 118	142 , 141
8 , 7	30 , 30	52 , 51	75 , 74	97 , 97	119 , 119	142 , 142
8 , 8	31 , 30	52 , 52	75 , 75	98 , 97	120 , 119	143 , 142
9 , 8	31 , 31	53 , 52	76 , 75	98 , 98	120 , 120	143 , 143
203 , 8	32 , 31	53 , 53	76 , 76	100 , 98	121 , 120	144 , 143
9 , 9	32 , 32	54 , 53	77 , 76	99 , 99	121 , 121	144 , 144
10 , 9	33 , 32	54 , 54	227 , 76	100 , 99	122 , 121	154 , 144
10 , 10	105 , 32	61 , 54	77 , 77	100 , 100	122 , 122	191 , 144
11 , 10	33 , 33	55 , 55	78 , 77	125 , 100	125 , 122	145 , 145
11 , 11	34 , 33	56 , 55	78 , 78	257 , 100	123 , 123	146 , 145
12 , 11	34 , 34	56 , 56	79 , 78	101 , 101	124 , 123	146 , 146
12 , 12	35 , 34	57 , 56	169 , 78	102 , 101	124 , 124	147 , 146
13 , 12	197 , 34	57 , 57	79 , 79	102 , 102	127 , 124	147 , 147
13 , 13	35 , 35	58 , 57	80 , 79	103 , 102	125 , 125	148 , 147
14 , 13	36 , 35	58 , 58	80 , 80	225 , 102	126 , 125	148 , 148
14 , 14	36 , 36	59 , 58	81 , 80	103 , 103	126 , 126	149 , 148
15 , 14	37 , 36	59 , 59	81 , 81	104 , 103	129 , 126	149 , 149
15 , 15	63 , 36	60 , 59	82 , 81	104 , 104	127 , 127	150 , 149
16 , 15	37 , 37	60 , 60	82 , 82	123 , 104	128 , 127	150 , 150
16 , 16	38 , 37	62 , 60	83 , 82	253 , 104	128 , 128	151 , 150
51 , 16	38 , 38	61 , 61	83 , 83	105 , 105	130 , 128	151 , 151
87 , 16	39 , 38	62 , 61	84 , 83	106 , 105	129 , 129	152 , 151
17 , 17	39 , 39	62 , 62	84 , 84	106 , 106	130 , 129	152 , 152
18 , 17	40 , 39	73 , 62	85 , 84	107 , 106	130 , 130	153 , 152
18 , 18	40 , 40	247 , 62	85 , 85	107 , 107	153 , 130	153 , 153
19 , 18	41 , 40	63 , 63	86 , 85	108 , 107	235 , 130	154 , 153
19 , 19	41 , 41	64 , 63	86 , 86	108 , 108	131 , 131	154 , 154
20 , 19	42 , 41	64 , 64	91 , 86	109 , 108	132 , 131	155 , 154
20 , 20	42 , 42	65 , 64	87 , 87	109 , 109	132 , 132	155 , 155
21 , 20	43 , 42	65 , 65	88 , 87	110 , 109	133 , 132	156 , 155
21 , 21	233 , 42	66 , 65	88 , 88	110 , 110	133 , 133	156 , 156
22 , 21	43 , 43	66 , 66	89 , 88	111 , 110	134 , 133	157 , 156
22 , 22	44 , 43	67 , 66	89 , 89	111 , 111	134 , 134	157 , 157
23 , 22	44 , 44	67 , 67	90 , 89	112 , 111	166 , 134	158 , 157
101 , 22	45 , 44	68 , 67	90 , 90	112 , 112	221 , 134	158 , 158

* Coordinates of elements with value “1” in submatrix T (273 rows, 273 columns). The coordinates are represented as R, C where R=row and C=column.

Table 6.2-13. LDPC Submatrix T for Subframe 3 * (sheet 2 of 2)

R , C	R , C	R , C	R , C	R , C	R , C	R , C
159 , 158	176 , 175	192 , 191	208 , 207	226 , 224	241 , 240	258 , 257
159 , 159	176 , 176	192 , 192	208 , 208	225 , 225	241 , 241	258 , 258
160 , 159	179 , 176	193 , 192	209 , 208	226 , 225	242 , 241	271 , 258
160 , 160	177 , 177	193 , 193	209 , 209	226 , 226	242 , 242	259 , 259
161 , 160	178 , 177	194 , 193	210 , 209	229 , 226	243 , 242	260 , 259
161 , 161	178 , 178	194 , 194	210 , 210	256 , 226	243 , 243	260 , 260
162 , 161	183 , 178	195 , 194	211 , 210	227 , 227	244 , 243	261 , 260
162 , 162	179 , 179	195 , 195	211 , 211	228 , 227	244 , 244	261 , 261
163 , 162	180 , 179	196 , 195	212 , 211	228 , 228	245 , 244	262 , 261
163 , 163	180 , 180	196 , 196	212 , 212	229 , 228	245 , 245	262 , 262
164 , 163	181 , 180	217 , 196	213 , 212	229 , 229	246 , 245	263 , 262
164 , 164	181 , 181	262 , 196	213 , 213	230 , 229	246 , 246	263 , 263
165 , 164	182 , 181	197 , 197	214 , 213	230 , 230	247 , 246	264 , 263
165 , 165	182 , 182	198 , 197	214 , 214	232 , 230	247 , 247	264 , 264
166 , 165	185 , 182	198 , 198	215 , 214	231 , 231	248 , 247	265 , 264
166 , 166	183 , 183	199 , 198	215 , 215	232 , 231	248 , 248	265 , 265
167 , 166	184 , 183	199 , 199	216 , 215	232 , 232	249 , 248	266 , 265
167 , 167	184 , 184	200 , 199	216 , 216	237 , 232	249 , 249	266 , 266
168 , 167	186 , 184	200 , 200	217 , 216	266 , 232	250 , 249	267 , 266
168 , 168	185 , 185	201 , 200	217 , 217	233 , 233	250 , 250	267 , 267
171 , 168	186 , 185	201 , 201	218 , 217	234 , 233	251 , 250	268 , 267
169 , 169	186 , 186	202 , 201	218 , 218	234 , 234	251 , 251	268 , 268
170 , 169	187 , 186	202 , 202	219 , 218	235 , 234	252 , 251	269 , 268
170 , 170	242 , 186	208 , 202	219 , 219	235 , 235	252 , 252	269 , 269
177 , 170	187 , 187	270 , 202	220 , 219	236 , 235	253 , 252	270 , 269
171 , 171	188 , 187	203 , 203	220 , 220	236 , 236	253 , 253	270 , 270
172 , 171	188 , 188	204 , 203	221 , 220	237 , 236	254 , 253	272 , 270
172 , 172	189 , 188	204 , 204	221 , 221	237 , 237	254 , 254	271 , 271
173 , 172	255 , 188	205 , 204	222 , 221	238 , 237	259 , 254	272 , 272
173 , 173	189 , 189	205 , 205	222 , 222	238 , 238	255 , 255	273 , 272
174 , 173	190 , 189	206 , 205	223 , 222	239 , 238	256 , 255	273 , 273
174 , 174	190 , 190	206 , 206	223 , 223	239 , 239	256 , 256	
175 , 174	196 , 190	207 , 206	224 , 223	240 , 239	257 , 256	
175 , 175	191 , 191	207 , 207	224 , 224	240 , 240	257 , 257	

* Coordinates of elements with value “1” in submatrix T (273 rows, 273 columns). The coordinates are represented as R, C where R=row and C=column.

Table 6.2-14. Number of 1's in LDPC Submatrix A for Subframe 2

ROW *								COLUMN **	
Row No.	# of 1's	Row No.	# of 1's	Row No.	# of 1's	Row No.	# of 1's	Column No.	# of 1's
2	7	208	5	392	5	537	7	1 through 73	3
31	7	225	7	415	5	542	5	74	2
44	5	229	5	423	5	545	5	75 through 310	3
83	7	232	5	424	7	572	5	311 through 321	4
91	7	234	7	442	7	577	5	322	3
93	7	244	5	446	5	581	5	323 through 352	4
110	5	263	5	472	5	594	5	353 through 401	5
119	5	269	4	478	5	597	5	402	4
123	7	289	5	484	5			403 through 467	5
134	7	299	7	487	5			468 through 478	7
154	7	304	5	498	5			479 & 480	14
155	5	305	7	505	7			481 through 484	15
162	5	335	5	510	5			485	14
165	7	346	5	512	5			486 through 526	15
178	5	361	5	515	5			527	14
205	5	382	7	532	5			528 through 600	15

* Row numbers not identified in this table have six 1's in each row.
** Column numbers identified as x through y specify the # of 1's in each column of x through y.

Table 6.2-15. Number of 1's in LDPC Submatrix T for Subframe 2

ROW *						COLUMN **					
Row No.	# of 1's	Row No.	# of 1's	Row No.	# of 1's	Column No.	# of 1's	Column No.	# of 1's	Column No.	# of 1's
1	1	361	3	515	3	2	3	146	3	322	3
119	3	392	3	542	3	6	3	148	3	330	3
162	3	415	3	545	3	26	3	162	3	364	3
208	3	446	3	572	3	32	3	172	3	384	3
232	3	472	3	577	3	34	3	176	3	446	3
244	3	478	3	581	3	50	3	208	3	472	3
269	3	484	3	594	3	52	3	210	3	512	3
289	3	487	3			54	3	304	3	598	1
304	3	498	3			76	3	314	3	599	1
346	3	512	3			98	3	318	3		

* Row numbers not identified in this table have two 1's in each row.
** Column numbers not identified in this table have two 1's in each column.

Table 6.2-16. Number of 1's in LDPC Submatrix A for Subframe 3

ROW *										COLUMN **	
Row No.	# of 1's	Row No.	# of 1's	Row No.	# of 1's	Row No.	# of 1's	Row No.	# of 1's	Column No.	# of 1's
1	6	58	6	107	6	175	6	227	6	1 through 22	3
3	4	59	6	111	6	177	6	228	6	23	2
5	6	60	6	112	6	178	6	229	4	24 through 85	3
8	6	61	6	113	6	180	6	231	7	86	2
9	6	63	6	115	6	181	6	235	4	87 through 177	3
10	6	65	6	118	6	182	6	236	6	178 through 193	4
14	6	68	6	121	6	185	6	237	4	194 through 226	11
15	6	69	6	129	6	190	6	239	6	227	10
17	7	70	6	133	6	192	6	240	6	228 through 274	11
18	6	71	4	136	6	193	6	244	6		
21	6	72	6	138	6	195	4	247	4		
22	6	74	6	142	6	196	4	248	6		
23	6	78	6	144	6	197	6	249	6		
26	6	79	6	147	6	198	6	250	6		
27	6	80	6	148	6	200	6	251	6		
28	6	82	6	149	6	201	6	253	4		
30	6	83	6	150	6	202	6	254	6		
34	6	86	6	151	6	203	6	255	6		
36	6	88	6	152	6	205	6	257	4		
38	6	89	6	155	4	207	6	258	6		
39	6	90	6	156	6	209	6	259	6		
40	6	91	6	159	6	211	6	261	6		
41	6	92	4	167	6	214	6	263	6		
45	6	94	6	168	6	215	6	265	6		
46	6	96	6	170	6	217	4	266	4		
48	6	98	6	171	6	218	6	269	6		
50	6	99	6	172	6	219	6	271	6		
51	6	103	6	173	6	220	6	273	6		
54	6	105	6	174	6	223	6				

* Row numbers not identified in this table have five 1's in each row.
 ** Column numbers identified as x through y specify the # of 1's in each column of x through y.

Table 6.2-17. Number of 1's in LDPC Submatrix T for Subframe 3

ROW *						COLUMN **					
Row No.	# of 1's	Row No.	# of 1's	Row No.	# of 1's	Column No.	# of 1's	Column No.	# of 1's	Column No.	# of 1's
1	1	166	3	237	3	2	3	76	3	188	3
17	1	186	3	242	3	8	3	78	3	196	3
62	3	196	3	247	3	16	3	92	3	202	3
73	3	208	3	253	3	22	3	100	3	226	3
92	3	217	3	256	3	32	3	102	3	232	3
100	3	221	3	257	3	34	3	104	3	271	1
125	3	226	3	262	3	36	3	116	3	273	1
130	3	229	3	266	3	42	3	130	3		
153	3	231	1	270	3	50	3	134	3		
154	3	232	3			62	3	144	3		
160	3	235	3			68	3	186	3		

* Row numbers not identified in this table have two 1's in each row.
 ** Column numbers not identified in this table have two 1's in each column.

6.2.5 Reserved Data

See paragraph 6.2.6 of IS-GPS-200.

6.2.6 Valid Range

See paragraph 6.2.7 of IS-GPS-200.

6.2.7 Invalid Range

See paragraph 6.2.8 of IS-GPS-200.

6.2.8 Clock, Ephemeris, Integrity (CEI) Data Set.

The Clock, Ephemeris, Integrity (CEI) data set is the collection of SV-specific clock correction polynomial parameters, ephemeris parameters, and related parameters (health flags, URA parameters, time tags, etc.) needed to use the SV's broadcast signal(s) in the positioning service. The parameters in the CEI data set are explicitly listed in Table 6.2-18. The entire CEI data set is needed for maximum accuracy. However, the core CEI data set (parameters without NOTE1 in Table 6.2-18) is sufficient for an initial position solution. The top term provides the epoch time of week of the state data utilized for the core CEI data set.

6.2.8.1 Core CEI Data Set.

A Core CEI Data Set are the CEI parameters necessary for a satellite to be used for a position solution (non-almanac); broadcast to users with the shortest broadcast interval. The t_{op} term provides the epoch time of week of the state data utilized for CEI data, except for parameters marked with a Note1 in Table 6.2-18.

Table 6.2-18. CEI Data Set Parameters

Symbol	Parameter Name	Subframe
\dot{A}	Change Rate in Semi-major Axis	2
ΔA	Semi-major Axis Difference at Reference Time	2
Δn_0	Mean Motion Difference from Computed Value at Reference Time	2
$\Delta \dot{n}_0$	Rate of Mean Motion Difference from Computed Value	2
Ω_0	Longitude of Ascending Node of Orbit Plane at Weekly Epoch	2
$\Delta \dot{\Omega}$	Rate of Right Ascension Difference	2
ω	Argument of Perigee	2
a_{f0}	SV Clock Bias Correction Coefficient	2
a_{f1}	SV Clock Drift Correction Coefficient	2
a_{f2}	Drift Rate Correction Coefficient Index	2
C_{ic}	Amplitude of the Cosine Harmonic Correction Term to the Angle of Inclination	2
C_{is}	Amplitude of the Sine Harmonic Correction Term to the Angle of Inclination	2
C_{rc}	Amplitude of the Cosine Harmonic Correction Term to the Orbit Radius	2
C_{rs}	Amplitude of the Sine Correction Term to the Orbit Radius	2
C_{uc}	Amplitude of Cosine Harmonic Correction Term to the Argument of Latitude	2
C_{us}	Amplitude of Sine Harmonic Correction Term to the Argument of Latitude	2
e	Eccentricity	2
i_0	Inclination Angle at Reference Time	2
$i_{0-n-DOT}$	Rate of Inclination Angle	2
ISC_{L1CP}	Inter-signal Correction	2
ISC_{L1CD}	Inter-signal Correction	2
ISC_{L1CA}	Inter-signal Correction	3
ISC_{L2C}	Inter-signal Correction	3
ISC_{L5I5}	Inter-signal Correction	3
ISC_{L5Q5}	Inter-signal Correction	3
ISF	Integrity Status Flag ^{NOTE1}	2
ITOW	Interval Time of Week	2
L1C	Signal Health (1 bits)	2

M_0	Mean Anomaly at Reference Time	2
T_{GD}	Group Delay Differential	2
t_{oe}	Time of Ephemeris	2
t_{op}	CEI Data Sequence Propagation Time of Week	2
URA _{ED} Index	Elevation Dependent User Range Accuracy, URA _{ED} Index	2
URA _{NED0} Index	NED Accuracy Index	2
URA _{NED1} Index	NED Accuracy Change Index	2
URA _{NED2} Index	NED Accuracy Change Rate Index	2
WN	Data Sequence Propagation Week Number	2
<p>NOTE1: Parameters so indicated are for CEI Refinement – not limited to curve fit. Parameters not indicated are needed for/limited to curve fit. Updates to parameters in table shall prompt changes in t_{oe}. Any parameter marked with NOTE1 may be changed with or without a change in t_{oe}.</p>		

6.2.9 CEI Data Sequence Propagation.

A related time-ordered sequence of CEI data sets in which each successive CEI data set is a time propagation of the preceding CEI data set. Special provisions apply to alert users to discontinuities separating one CEI data sequence propagation from another CEI data sequence propagation (e.g., after an upload occurs). An upload may include multiple segments of temporally continuous CEI Data sequence propagations.

6.3 Supporting Material

6.3.1 Additional PRN Sequences

This section provides additional PRN sequences for information only and the additional PRN sequences are for other L1C signal applications, including other GNSS and Satellite Based Augmentation System (SBAS) satellite signals. These PRN sequences are known to have good cross correlation properties relative to PRN sequences 1-63. PRN sequences numbered 211-1023 are reserved for internal system use and are therefore not provided in this section.

6.3.1.1 Additional L1C Ranging Code Sequences

Table 6.3-1 provides additional sequences for L1C_P-code and L1C_D-code. See Section 3.2.2.1.1 for the code generation.

Table 6.3-1. Additional L1C Ranging Codes Parameter Assignments (sheet 1 of 7)

PRN Signal No.	L1C _P				L1C _D			
	Weil Index (<i>w</i>)	Insertion Index (<i>p</i>)	Initial 24 Chips (Octal)	Final 24 Chips (Octal)	Weil Index (<i>w</i>)	Insertion Index (<i>p</i>)	Initial 24 Chips (Octal)	Final 24 Chips (Octal)
64	5065	9429	02447300	44305246	4955	9899	64477030	04573761
65	5063	77	71725674	00460475	5018	4629	15665564	03677302
66	5055	932	25453304	05674447	4642	669	44273171	47762107
67	5012	5973	14574042	36357263	4840	4378	00245661	71201242
68	4981	377	74661664	42702346	4961	4528	05562715	61227172
69	4952	10000	23576062	32521054	4263	9718	07374424	07244400
70	4934	951	41542650	42476101	5011	5485	67651746	01611101
71	4932	6212	01104546	61116204	4922	6222	67552565	23566142
72	4786	686	33434042	04262600	4317	672	25244755	52125666
73	4762	9352	21774465	01545263	3636	1275	55656370	55064114
74	4640	5999	40262622	40375205	4884	6083	30605453	33642702
75	4601	9912	56142774	40344363	5041	5264	61613023	02603370
76	4563	9620	43202027	50372155	4912	10167	71661742	50247376
77	4388	635	04516115	33621000	4504	1085	50524332	00326425
78	3820	4951	74662364	36551057	4617	194	10511616	63512437
79	3687	5453	52076567	27766445	4633	5012	24037773	10407511
80	5052	4658	47474451	52411766	4566	4938	63337466	22042777
81	5051	4800	02211543	33572343	4702	9356	43413024	27047165
82	5047	59	23163471	56266077	4758	5057	22004634	43767732
83	5039	318	25176610	31141052	4860	866	16354567	02577001
84	5015	571	14457237	42211412	3962	2	55154652	45652666
NOTES:								

Table 6.3-1. Additional L1C Ranging Codes Parameter Assignments (sheet 2 of 7)

PRN Signal No.	L1C _P				L1C _D			
	Weil Index (<i>w</i>)	Insertion Index (<i>p</i>)	Initial 24 Chips (Octal)	Final 24 Chips (Octal)	Weil Index (<i>w</i>)	Insertion Index (<i>p</i>)	Initial 24 Chips (Octal)	Final 24 Chips (Octal)
85	5005	565	17254300	51377401	4882	204	77375306	37351344
86	4984	9947	17501057	06740644	4467	9808	62125702	56325175
87	4975	4654	50364001	15746533	4730	4365	60360471	34116400
88	4974	148	45555767	10015665	4910	162	67160364	23450053
89	4972	3929	00107361	73402571	4684	367	17351730	27646414
90	4962	293	50312164	77323304	4908	201	44400061	15313636
91	4913	178	20514052	15263715	4759	18	07046264	32022604
92	4907	10142	03627757	10233327	4880	251	26443275	16273455
93	4903	9683	03102361	57310034	4095	10167	42362501	21406562
94	4833	137	07637647	77143271	4971	21	61464206	63177644
95	4778	565	72757527	43465043	4873	685	00304675	13677122
96	4721	35	74713660	00574365	4561	92	01474411	43477217
97	4661	5949	47776235	44401766	4588	1057	43152275	60145564
98	4660	2	15011643	34576343	4773	3	66447224	62047761
99	4655	5982	70055175	31725507	4997	5756	32506067	66757271
100	4623	825	13300130	67312706	4583	14	27071504	74435373
101	4590	9614	51731304	46621603	4900	9979	75221557	77647321
102	4548	9790	17630510	64345411	4574	9569	03454571	17534646
103	4461	5613	63203440	61602741	4629	515	72272760	07321605
104	4442	764	14332223	54253415	4676	753	31706274	67422013
105	4347	660	76103604	43302054	4181	1181	42747572	06767032
NOTES:								

Table 6.3-1. Additional L1C Ranging Codes Parameter Assignments (sheet 3 of 7)

PRN Signal No.	L1C _P				L1C _D			
	Weil Index (<i>w</i>)	Insertion Index (<i>p</i>)	Initial 24 Chips (Octal)	Final 24 Chips (Octal)	Weil Index (<i>w</i>)	Insertion Index (<i>p</i>)	Initial 24 Chips (Octal)	Final 24 Chips (Octal)
106	4259	4870	37324636	03453741	5057	9442	63335441	61365314
107	4256	4950	26603302	52233056	4944	669	21777623	41010744
108	4166	4881	02757505	43130175	4401	4834	51543753	53655472
109	4155	1151	55462247	12241054	4586	541	21406443	65430511
110	4109	9977	40577461	75365233	4699	9933	61270463	50672434
111	4100	5122	17433077	21435116	3676	6683	07270323	34014107
112	4023	10074	04115442	40670365	4387	4828	23660721	03066030
113	3998	4832	13154727	64265263	4866	9710	77637043	61651100
114	3979	77	77057317	30074057	4926	10170	12433652	05570472
115	3903	4698	01513425	75121550	4657	9629	05304706	01521516
116	3568	1002	05132465	54744641	4477	260	77452705	67160335
117	5088	5549	50104501	05312042	4359	86	52354405	03517044
118	5050	9606	60523106	43103551	4673	5544	06041146	34634123
119	5020	9228	22246740	51372531	4258	923	76175470	17153350
120	4990	604	12364050	42135401	4447	257	15006176	53272671
121	4982	4678	32514207	30171775	4570	507	07111630	37064353
122	4966	4854	67423664	10455535	4486	4572	21205723	20146433
123	4949	4122	77266167	01324227	4362	4491	72653641	14613666
124	4947	9471	46461421	31664661	4481	341	10436256	15435310
125	4937	5026	44731317	05002237	4322	130	52721673	44561325
126	4935	272	40352277	30601263	4668	79	30153343	41722542
NOTES:								

Table 6.3-1. Additional L1C Ranging Codes Parameter Assignments (sheet 4 of 7)

PRN Signal No.	L1C _P				L1C _D			
	Weil Index (<i>w</i>)	Insertion Index (<i>p</i>)	Initial 24 Chips (Octal)	Final 24 Chips (Octal)	Weil Index (<i>w</i>)	Insertion Index (<i>p</i>)	Initial 24 Chips (Octal)	Final 24 Chips (Octal)
127	4906	1027	60334000	52663163	3967	1142	46031334	33221302
128	4901	317	31414460	42263623	4374	448	52705400	15637431
129	4872	691	21565451	53041061	4553	875	71133426	57572470
130	4865	509	16330346	66052070	4641	555	43512313	35007473
131	4863	9708	32652065	04013232	4215	1272	77673747	16425373
132	4818	5033	26514154	67750663	3853	5198	15633060	34372463
133	4785	9938	34231746	54647730	4787	9529	24027652	25230460
134	4781	4314	76662461	15133614	4266	4459	22453455	53327223
135	4776	10140	47747731	01314434	4199	10019	01620441	01513007
136	4775	4790	02344033	56230626	4545	9353	24652730	64542663
137	4754	9823	66173226	45676614	4208	9780	53141737	53274351
138	4696	6093	73016727	47111161	4485	375	71125036	46715625
139	4690	469	77312770	52710401	3714	503	07542336	54164205
140	4658	1215	51646142	36536254	4407	4507	16114445	53416247
141	4607	799	56016363	02567340	4182	875	46740433	20023005
142	4599	756	42604563	61470650	4203	1246	55271356	44253547
143	4596	9994	31351337	54031347	3788	1	32216472	03043444
144	4530	4843	27106364	22157757	4471	4534	23356330	30510313
145	4524	5271	41653674	34140067	4691	8	35551350	10154063
146	4451	9661	41723426	13666204	4281	9549	57761372	33147336
147	4441	6255	67572676	30653236	4410	6240	30253244	15601652
NOTES:								

Table 6.3-1. Additional L1C Ranging Codes Parameter Assignments (sheet 5 of 7)

PRN Signal No.	L1C _P				L1C _D			
	Weil Index (<i>w</i>)	Insertion Index (<i>p</i>)	Initial 24 Chips (Octal)	Final 24 Chips (Octal)	Weil Index (<i>w</i>)	Insertion Index (<i>p</i>)	Initial 24 Chips (Octal)	Final 24 Chips (Octal)
148	4396	5203	13221317	26243171	3953	22	52100453	23705421
149	4340	203	00546077	16413664	3465	5652	51034421	41130727
150	4335	10070	26001221	55366035	4801	10069	16015465	71256351
151	4296	30	25023624	22432004	4278	4796	50647656	51262411
152	4267	103	06170665	13123426	4546	4980	12572136	64470526
153	4168	5692	56716445	52547645	3779	27	70330016	56143230
154	4149	32	42176035	56243100	4115	90	15527641	00472356
155	4097	9826	54672466	40035633	4193	9788	11434413	53374420
156	4061	76	30010163	23111613	3372	715	16327052	70130674
157	3989	59	12460454	45324016	3786	9720	21517504	71211135
158	3966	6831	02433231	43266171	3491	301	22752764	24514303
159	3789	958	44262655	33672171	3812	5450	21041013	66000624
160	3775	1471	74466417	45007430	3594	5215	30150603	44124121
161	3622	10070	40534627	47162164	4028	13	04373224	72305275
162	3523	553	77507301	14403627	3652	1147	11502362	34315206
163	3515	5487	77047741	07244501	4224	4855	00247305	65100431
164	3492	55	06772006	64545666	4334	1190	72427277	30205426
165	3345	208	40473120	12372447	3245	1267	25646343	41567071
166	3235	645	34300604	13076376	3921	1302	56324170	63121546
167	3169	5268	65107417	40367614	3840	1	32142641	65356365
168	3157	1873	70400121	74416333	3514	5007	56004007	55254670
NOTES:								

Table 6.3-1. Additional L1C Ranging Codes Parameter Assignments (sheet 6 of 7)

PRN Signal No.	L1C _P				L1C _D			
	Weil Index (<i>w</i>)	Insertion Index (<i>p</i>)	Initial 24 Chips (Octal)	Final 24 Chips (Octal)	Weil Index (<i>w</i>)	Insertion Index (<i>p</i>)	Initial 24 Chips (Octal)	Final 24 Chips (Octal)
169	3082	427	25212235	01370063	2922	549	75210756	70737175
170	3072	367	74600422	46656071	4227	368	53764644	70767133
171	3032	1404	12032423	31523361	3376	6300	27301136	74626324
172	3030	5652	13632510	17725050	3560	5658	62522732	50344217
173*	4582	5	71510055	60560145	4989	4302	64555743	77720230
174*	4595	368	75143230	70762153	4756	851	75635153	61374142
175*	4068	451	45520711	63715635	4624	4353	65657537	63150674
176*	4871	9595	71255143	33356000	4446	9618	67024710	73243704
177*	4514	1030	74432602	60240565	4174	9652	33425256	62635540
178*	4439	1324	64502543	37553063	4551	1232	27012711	62337332
179*	4122	692	62244257	57024466	3972	109	01142615	10746114
180*	4948	9819	56114714	56224523	4399	10174	63104766	43352532
181*	4774	4520	20545772	71662723	4562	6178	40126774	32603456
182*	3923	9911	34440721	52501713	3133	1851	51100156	12547126
183*	3411	278	27113701	32506507	4157	1299	23271257	17203343
184*	4745	642	55315473	51205405	5053	325	54126675	10756735
185*	4195	6330	03002035	13765021	4536	10206	52457352	64624731
186*	4897	5508	22413634	25612410	5067	9968	57355463	67422311
187*	3047	1872	50147661	27377757	3905	10191	43536147	22501761
188*	4185	5445	36713526	21553277	3721	5438	77173403	74416242
189*	4354	10131	67255070	21044121	3787	10080	00260547	57357212

NOTES:
* Codes 173-202 are extra codes that are suited for use with a BOC (1,1) pilot component

Table 6.3-1. Additional L1C Ranging Codes Parameter Assignments (sheet 7 of 7)

PRN Signal No.	L1C _P				L1C _D			
	Weil Index (<i>w</i>)	Insertion Index (<i>p</i>)	Initial 24 Chips (Octal)	Final 24 Chips (Octal)	Weil Index (<i>w</i>)	Insertion Index (<i>p</i>)	Initial 24 Chips (Octal)	Final 24 Chips (Octal)
190*	5077	422	17310715	71430410	4674	219	57155443	44305226
191*	4042	4918	20674706	01406234	3436	758	77502633	30766330
192*	2111	787	21764400	10264531	2673	2140	25162476	67406576
193*	4311	9864	70670250	11640746	4834	9753	54420241	43473502
194*	5024	9753	24737373	51661203	4456	4799	75476311	32402217
195*	4352	9859	04467202	15610600	4056	10126	50612163	43454074
196*	4678	328	02551300	70117174	3804	241	77772455	06321507
197*	5034	1	32252546	77615261	3672	1245	03320402	22101365
198*	5085	4733	10121331	22447126	4205	1274	20225612	67251717
199*	3646	164	10537634	65022442	3348	1456	55426411	02047657
200*	4868	135	32014275	41243522	4152	9967	70477545	43352227
201*	3668	174	13126037	56605536	3883	235	71116442	04471535
202*	4211	132	60700561	13020736	3473	512	42077151	62510717
203	2883	538	75356470	15605531	3669	1078	65203721	00366214
204	2850	176	20543613	02371410	3455	1078	42436531	32276151
205	2815	198	33767061	10107642	2318	953	21017627	77470652
206	2542	595	05734074	10115665	2945	5647	62667326	72435665
207	2492	574	36277063	72611614	2947	669	56255552	14160206
208	2376	321	04163243	56150655	3220	1311	13413261	64235022
209	2036	596	71443237	54060273	4052	5827	55443510	21663362
210	1920	491	26113110	12644254	2953	15	67734642	20171640

NOTES:
* Codes 173-202 are extra codes that are suited for use with a BOC (1,1) pilot component

6.3.1.2 Additional L1C Overlay Code Sequences

The additional L1C_O-code sequences are derived from Gold Sequences, which are the exclusive-or addition of two sequences S1 and S2. The S1 sequence is defined by one of the following four polynomials:

$$1 + x^3 + x^6 + x^9 + x^{11} \quad \text{Octal 5111,}$$

$$1 + x^4 + x^8 + x^9 + x^{11} \quad \text{Octal 5421,}$$

$$1 + x + x^8 + x^9 + x^{11} \quad \text{Octal 5403,}$$

and $1 + x^6 + x^8 + x^{10} + x^{11} \quad \text{Octal 6501.}$

The second sequence, S2, is fixed and is defined by polynomial:

$$1 + x^9 + x^{11} \quad \text{Octal 5001.}$$

Each polynomial generates a sequence using a specified initial condition, e.g., S1(t) and S2(t). The additional L1C_O-code sequences are then defined by L1C_{Oi}(t) = S1(t) ⊕ S2(t) for i = 64 to 210. Table 6.3-2 specifies the L1C_O-code parameters for PRN signal numbers 64 - 210. See Figure 3.2-2 for a conceptual code generator for these additional L1C_O-code sequences.

Table 6.3-2. Additional L1C_O Overlay Code Parameter Assignments (sheet 1 of 7)

PRN Signal No.	S1 Polynomial Coefficient (Octal) * (m _{i,j})	S1 Initial Condition (Octal †) **	S2 Initial Condition (Octal †) **	Initial 11 Symbols (Octal †)	Final 11 Symbols (Octal †)
64	5111	1740	3035	2775	2145
65	5111	3664	1557	2333	1656
66	5111	1427	0237	1610	0356
67	5111	2627	2527	0300	0753
68	5111	0701	3307	3406	3403
69	5111	3460	1402	2062	2765
70	5111	1373	1225	0156	1713
71	5111	2540	0607	2347	3177
72	5111	2004	0351	2355	1310
73	5111	2274	3724	1550	1203
74	5111	1340	1675	0535	3267
75	5111	0602	2625	2027	3240
76	5111	2502	1030	3532	2055
77	5111	0327	1443	1764	1435
78	5111	2600	3277	1477	0243
79	5111	0464	1132	1556	0736
80	5111	3674	0572	3306	2671
81	5111	3040	1241	2201	0322
82	5111	1153	0535	1466	3716
83	5111	0747	1366	1421	2742
84	5111	1770	0041	1731	0671

NOTES:

* The polynomial coefficient is given as m₁₁, ..., m₀. Thus octal 5111 corresponds to the generator polynomial 1 + x³ + x⁶ + x⁹ + x¹¹.

** The initial condition is given as n₁₁, ..., n₁. (See Figure 3.2-2)

† The initial bit value 0 is dropped to obtain 11 symbols. Thus octal 3035 corresponds to 11 values 1 1 0 0 0 0 1 1 1 0 1.

Table 6.3-2. Additional L1Co Overlay Code Parameter Assignments (sheet 2 of 7)

PRN Signal No.	S1 Polynomial Coefficient (Octal) * ($m_{i,j}$)	S1 Initial Condition (Octal †) **	S2 Initial Condition (Octal †) **	Starting 11 Symbols (Octal †)	Ending 11 Symbols (Octal †)
85	5111	3772	0561	3213	2735
86	5111	1731	0122	1613	0021
87	5111	1672	1205	0477	0631
88	5111	1333	3753	2460	3537
89	5111	2705	2543	0246	3620
90	5111	2713	3031	1722	1622
91	5111	3562	2260	1702	1173
92	5111	3245	3773	0536	2673
93	5111	3770	3156	0626	2737
94	5111	3202	2215	1017	3121
95	5111	3521	0146	3467	1760
96	5111	3250	2413	1643	2600
97	5111	2117	2564	0473	3400
98	5111	0530	3310	3620	1176
99	5111	3021	2267	1246	0514
100	5421	2511	3120	1431	1644
101	5421	1562	0064	1506	3554
102	5421	1067	1042	0025	1161
103	5421	0424	0476	0052	0333
104	5421	3402	1020	2422	1620
105	5421	1326	0431	1717	2000

NOTES:

* The polynomial coefficient is given as m_{11}, \dots, m_0 . Thus octal 5111 corresponds to the generator polynomial $1 + x^3 + x^6 + x^9 + x^{11}$.

** The initial condition is given as n_{11}, \dots, n_1 . (See Figure 3.2-2)

† The initial bit value 0 is dropped to obtain 11 symbols. Thus octal 3035 corresponds to 11 values 1 1 0 0 0 0 1 1 1 0 1.

Table 6.3-2. Additional L1Co Overlay Code Parameter Assignments (sheet 3 of 7)

PRN Signal No.	S1 Polynomial Coefficient (Octal) * ($m_{i,j}$)	S1 Initial Condition (Octal †) **	S2 Initial Condition (Octal †) **	Starting 11 Symbols (Octal †)	Ending 11 Symbols (Octal †)
106	5421	2142	0216	2354	2655
107	5421	0733	2736	2005	0320
108	5421	0504	2527	2023	1103
109	5421	1611	2431	3220	3531
110	5421	2724	1013	3737	0723
111	5421	0753	0524	0277	0023
112	5421	3724	0726	3002	2312
113	5421	2652	1042	3610	1723
114	5421	1743	3362	2421	3065
115	5421	0013	1364	1377	1565
116	5421	3464	3354	0730	1211
117	5421	2300	0623	2523	3610
118	5421	1334	0145	1271	3602
119	5421	2175	0214	2361	1155
120	5421	2564	0223	2747	1166
121	5421	3075	0151	3124	2207
122	5421	3455	2405	1050	2673
123	5421	3627	2522	1305	2703
124	5421	0617	3235	3422	3613
125	5421	1324	0452	1776	1065
126	5421	3506	2617	1311	3270

NOTES:

* The polynomial coefficient is given as m_{11}, \dots, m_0 . Thus octal 5111 corresponds to the generator polynomial $1 + x^3 + x^6 + x^9 + x^{11}$.

** The initial condition is given as n_{11}, \dots, n_1 . (See Figure 3.2-2)

† The initial bit value 0 is dropped to obtain 11 symbols. Thus octal 3035 corresponds to 11 values 1 1 0 0 0 0 1 1 1 0 1.

Table 6.3-2 Additional L1Co Overlay Code Parameter Assignments (Sheet 4 of 7)

PRN Signal No.	S1 Polynomial Coefficient (Octal) * ($m_{i,j}$)	S1 Initial Condition (Octal †) **	S2 Initial Condition (Octal †) **	Starting 11 Symbols (Octal †)	Ending 11 Symbols (Octal †)
127	5421	2231	1300	3131	0040
128	5421	1110	1430	0520	2541
129	5421	1271	0773	1502	0673
130	5421	3740	0772	3032	0161
131	5421	3652	3561	0333	0143
132	5421	1644	0607	1043	1040
133	5421	3635	0420	3215	0227
134	5421	3436	0527	3111	3523
135	5421	3076	3770	0706	3452
136	5421	0434	2536	2102	1451
137	5421	3340	2233	1173	1677
138	5421	0054	3366	3332	1650
139	5403	2446	3766	1320	0712
140	5403	0025	3554	3571	3305
141	5403	0150	2060	2130	3603
142	5403	2746	2070	0736	1607
143	5403	2723	0713	2030	2301
144	5403	2601	3366	1567	0420
145	5403	3440	3247	0607	0707
146	5403	1312	2776	3464	2331
147	5403	0544	1244	1700	1705

NOTES:

* The polynomial coefficient is given as m_{11}, \dots, m_0 . Thus octal 5111 corresponds to the generator polynomial $1 + x^3 + x^6 + x^9 + x^{11}$.

** The initial condition is given as n_{11}, \dots, n_1 . (See Figure 3.2-2)

† The initial bit value 0 is dropped to obtain 11 symbols. Thus octal 3035 corresponds to 11 values 1 1 0 0 0 0 1 1 1 0 1.

Table 6.3-2 Additional L1Co Overlay Code Parameter Assignments (Sheet 5 of 7)

PRN Signal No.	S1 Polynomial Coefficient (Octal) * ($m_{i,j}$)	S1 Initial Condition (Octal †) **	S2 Initial Condition (Octal †) **	Starting 11 Symbols (Octal †)	Ending 11 Symbols (Octal †)
148	5403	2062	2102	0160	3566
149	5403	0176	1712	1664	3165
150	5403	3616	1245	2453	2020
151	5403	1740	3344	2404	0100
152	5403	3777	1277	2500	1627
153	5403	0432	0165	0557	3170
154	5403	2466	2131	0557	2200
155	5403	1667	3623	2044	2217
156	5403	3601	0141	3740	3133
157	5403	2706	0421	2327	2340
158	5403	2022	3032	1010	1337
159	5403	1363	2065	3306	3741
160	5403	2331	3024	1315	3215
161	5403	3556	2663	1335	3617
162	5403	2205	2274	0071	3034
163	5403	3734	2114	1620	1473
164	5403	2115	1664	3771	0063
165	5403	0010	0413	0403	1102
166	5403	2140	1512	3452	2330
167	5403	3136	0135	3003	2520
168	5403	0272	2737	2545	1077

NOTES:

* The polynomial coefficient is given as m_{11}, \dots, m_0 . Thus octal 5111 corresponds to the generator polynomial $1 + x^3 + x^6 + x^9 + x^{11}$.

** The initial condition is given as n_{11}, \dots, n_1 . (See Figure 3.2-2)

† The initial bit value 0 is dropped to obtain 11 symbols. Thus octal 3035 corresponds to 11 values 1 1 0 0 0 0 1 1 1 0 1.

Table 6.3-2 Additional L1Co Overlay Code Parameter Assignments (Sheet 6 of 7)

PRN Signal No.	S1 Polynomial Coefficient (Octal) * ($m_{i,j}$)	S1 Initial Condition (Octal †) **	S2 Initial Condition (Octal †) **	Starting 11 Symbols (Octal †)	Ending 11 Symbols (Octal †)
169	5403	3264	1015	2271	1304
170	5403	2017	1075	3062	1061
171	5403	2505	1255	3750	1741
172	5403	3532	3473	0141	1774
173	5403	0647	2716	2151	2374
174	5403	1542	0101	1443	0473
175	5403	2154	1105	3051	0713
176	5403	3734	1407	2333	3773
177	5403	2621	3407	1226	0321
178	5403	2711	1046	3757	2530
179	5403	0217	3237	3020	0267
180	5403	3503	0154	3457	3763
181	5403	3457	3010	0447	0570
182	5403	3750	2245	1515	2742
183	5403	2525	2051	0574	1142
184	5403	0113	2144	2057	1135
185	5403	0265	1743	1526	1456
186	5403	1711	2511	3200	1717
187	5403	0552	3410	3142	3556
188	5403	0675	1414	1261	1440
189	5403	1706	1275	0573	2600

NOTES:

* The polynomial coefficient is given as m_{11}, \dots, m_0 . Thus octal 5111 corresponds to the generator polynomial $1 + x^3 + x^6 + x^9 + x^{11}$.

** The initial condition is given as n_{11}, \dots, n_1 . (See Figure 3.2-2)

† The initial bit value 0 is dropped to obtain 11 symbols. Thus octal 3035 corresponds to 11 values 1 1 0 0 0 0 1 1 1 0 1.

Table 6.3-2 Additional L1Co Overlay Code Parameter Assignments (Sheet 7 of 7)

PRN Signal No.	S1 Polynomial Coefficient (Octal) * ($m_{i,j}$)	S1 Initial Condition (Octal †) **	S2 Initial Condition (Octal †) **	Starting 11 Symbols (Octal †)	Ending 11 Symbols (Octal †)
190	5403	3513	2257	1744	1676
191	5403	1135	2331	3204	2226
192	5403	0566	0276	0710	0231
193	5403	0500	3261	3761	1676
194	5403	0254	1760	1534	1620
195	5403	3445	0430	3075	2340
196	5403	2542	3477	1135	3477
197	5403	1257	1676	0421	3241
198	6501	0211	1636	1427	3011
199	6501	0534	2411	2125	0674
200	6501	1420	1473	0053	1746
201	6501	3401	2266	1667	1110
202	6501	0714	2104	2610	1415
203	6501	0613	2070	2663	2627
204	6501	2475	1766	3313	2471
205	6501	2572	0711	2263	0057
206	6501	3265	2533	1756	3364
207	6501	1250	0353	1103	1762
208	6501	1711	1744	0055	2317
209	6501	2704	0053	2757	0755
210	6501	0135	2222	2317	1145

NOTES:

* The polynomial coefficient is given as m_{11}, \dots, m_0 . Thus octal 5111 corresponds to the generator polynomial $1 + x^3 + x^6 + x^9 + x^{11}$.

** The initial condition is given as n_{11}, \dots, n_1 . (See Figure 3.2-2)

† The initial bit value 0 is dropped to obtain 11 symbols. Thus octal 3035 corresponds to 11 values 1 1 0 0 0 0 1 1 1 0 1.

6.3.2 Pre-Operational Use

Before any new signal or group of signals (e.g., L2C, L5, M, L1C, etcetera) is declared operational, the availability of and/or the configuration of the broadcast signal or group of signals may not comply with all requirements of the relevant IS or ICD. For example, the pre-operational broadcast of L2C signals from the IIR-M satellites did not include any LNAV or CNAV data as required by IS-GPS-200. Pre-operational use of any new signal or group of signals is at the users own risk.

6.3.3 Integrated Phase Noise Characteristics.

As an aid to user equipment receiver designers, a plot is provided (Figure 6-1) of a typical GPS III and GPS III F phase noise spectral density for the un-modulated L1C carrier.

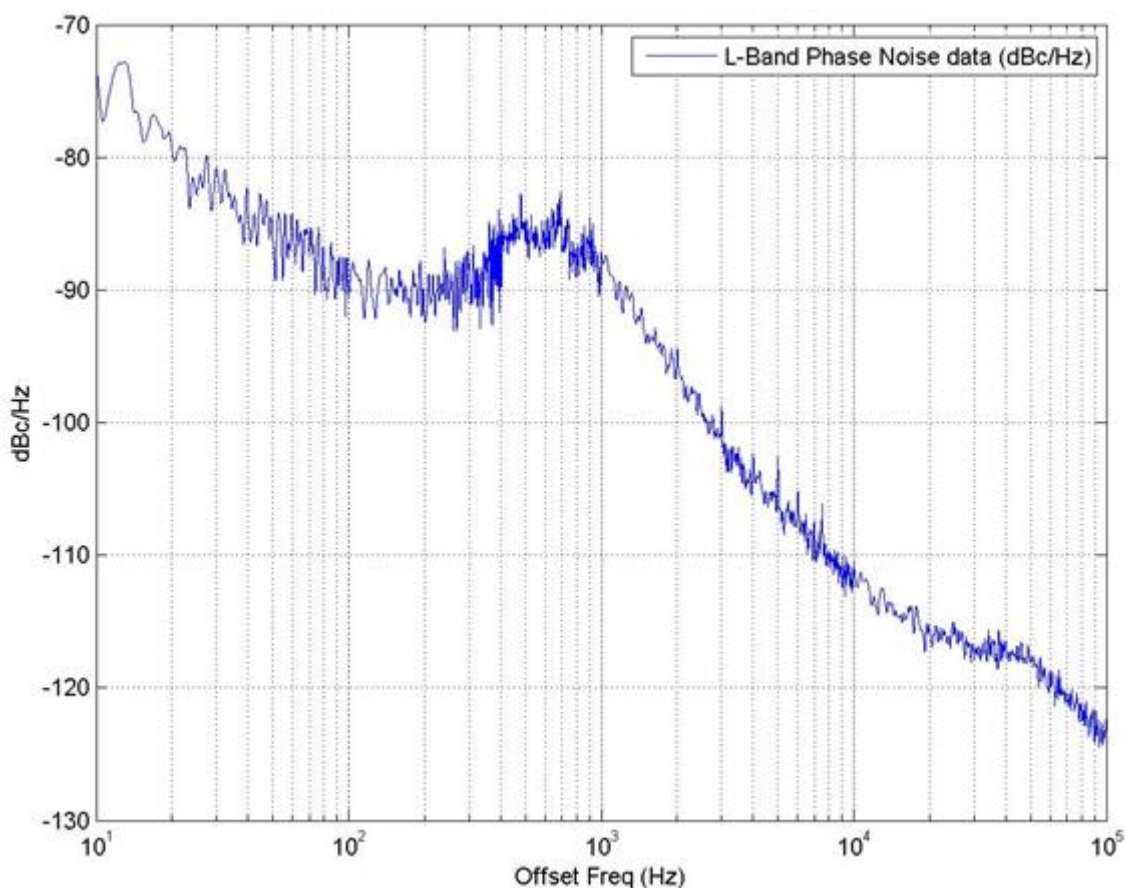

Figure 6-1 Typical GPS III and GPS III F L1C Carrier Phase Noise Spectral Density

6.4 Operational Protocols

6.4.1 Lower PRN Numbers Versus Upper PRN Numbers

See IS-GPS-200.

6.4.2 PRN Number Consistency

For a given satellite, the same PRN number will be assigned to all operational signals (signals modulated by standard PRN code with data that indicates the signal health is OK).

6.4.3 PRNs 33 and 37

See IS-GPS-200.

6.4.4 PRNs 33 through 63

See IS-GPS-200.

6.4.5 User Protocol for Signal Availability and Health Information

See paragraph 6.4.6 of IS-GPS-200.

6.4.5.1 Alarm Indications

6.4.5.1.1 Specific Alarm Indications

(Reserved)

6.4.5.2 "Marginal" Indications

(Reserved)