



U.S. Department of Homeland Security
United States Coast Guard

LOCAL NOTICE TO MARINERS

District: 1

Week: 02/23

COASTAL WATERS FROM EASTPORT, MAINE TO SHREWSBURY, NEW JERSEY

NOTES:

- (1) Unless otherwise indicated, missing and destroyed structures are presumed to be in the immediate vicinity of assigned position. Mariners should proceed with caution.
(2) The Local Notice to Mariners is a weekly edition.
(3) Inquiries, published articles or Information: mail to: D01-SMB-LNM@uscg.mil
(4) The U.S. Coast Pilot supplements the navigational information shown on nautical charts.
(5) The Coast Pilot, along with its corrections, are available online at https://nauticalcharts.noaa.gov/publications/coast-pilot/index.html.

The Local Notice to Mariners is available online at https://www.navcen.uscg.gov/?pageName=lnmMain
Updated 2021 Light List is available online: https://www.navcen.uscg.gov/pdf/lightLists/weeklyUpdates/v1d01WeeklyChanges.pdf
Information on Private Aids to Navigation is available at: http://www.usharbormaster.com/
Reports of Channel conditions can be found at the Army Corps of Engineers website at: http://www.nan.usace.army.mil/Missions/Navigation/ControllingDepthReports.aspx.
NOAA Tides and Currents can be found at: http://www.tidesandcurrents.noaa.gov/.

The United States Coast Guard Navigation Information Service (NIS), operated by the USCG Navigation Center, is staffed 24 hours a day, 7 days a week. The NIS provides information on the current operational status, effective policies, and general information for GPS and DGPS. The NIS also disseminates Safety Broadcasts (BNM), Local Notice to Mariners (LNM), and the latest Notice Advisory to Navstar Users (NANU). NANU notices can be obtained via email subscription through the USCG Navigation Center website: https://www.navcen.uscg.gov/?Do=constellationStatus. In addition, the NIS investigates all reports of degradation or loss of GPS, DGPS or AIS service. Users are encouraged to report all degradation or loss of radio navigation services to the NIS via any of the following: Phone: (703) 313-5900, mail to: tis-sg-nisws@uscg.mil, or on the internet at: https://www.navcen.uscg.gov.

PLEASE IMMEDIATELY REPORT DISCREPANCIES IN AIDS TO NAVIGATION TO THE NEAREST COAST GUARD UNIT

COMMANDER, FIRST COAST GUARD DISTRICT (dpw)
408 Atlantic Avenue, Boston, Massachusetts 02110-3350
Telephone: (617) 223-8356
24 Hour FAX: (617) 223-8094
http://www.uscg.mil/d1/prevention/Marineinfoeregulations.asp

All bearings are in degrees TRUE - All times are in Local Time unless otherwise noted.

ABBREVIATIONS

A through H

ADRIFT - Buoy Adrift
AICW - Atlantic Intracoastal Waterway
AI - Alternating
B - Buoy
BKW - Breakwater
bl - Blast
BNM - Broadcast Notice to Mariner
bu - Blue
C - Canadian
CHAN - Channel
CGD - Coast Guard District
C/O - Cut Off
CONT - Contour
CRK - Creek
CONST - Construction

I through O

I - Interrupted
ICW - Intracoastal Waterway
IMCH - Improper Characteristic
INL - Inlet
INOP - Not Operating
INT - Intensity
ISL - Islet
Iso - Isophase
kHz - Kilohertz
LAT - Latitude
LB - Lighted Buoy
LBB - Lighted Bell Buoy
LHB - Lighted Horn Buoy
LGB - Lighted Gong Buoy
LONG - Longitude

P through Z

PRIV - Private Aid
Q - Quick
R - Red
RACON - Radar Transponder Beacon
Ra ref - Radar reflector
RBN - Radio Beacon
REBUILT - Aid Rebuilt
RECOVERED - Aid Recovered
RED - Red Buoy
REFL - Reflective
RRL - Range Rear Light
RELIGHTED - Aid Relit
RELOC - Relocated
RESET ON STATION - Aid Reset on Station
RFL - Range Front Light

DAYMK/Daymk - Daymark
DBN/Dbn - Daybeacon
DBD/DAYBD - Dayboard
DEFAC - Defaced
DEST - Destroyed
DISCON - Discontinued
DMGD/DAMGD - Damaged
ec - eclipse
EST - Established Aid
ev - every
EVAL - Evaluation
EXT - Extinguished
F - Fixed
fl - flash
FI - Flashing
G - Green
GIWW - Gulf Intracoastal Waterway
HAZ - Hazard to Navigation
HBR - Harbor
HOR - Horizontal Clearance
HT - Height

LNM - Local Notice to Mariners
LT - Light
LT CONT - Light Continuous
LTR - Letter
LWB - Lighted Whistle Buoy
LWP - Left Watching Properly
MHz - Megahertz
MISS/MSNG - Missing
Mo - Morse Code
MRASS - Marine Radio Activated Sound Signal
MSLD - Misleading
N/C - Not Charted
NGA - National Geospatial-Intelligence Agency
NO/NUM - Number
NOS - National Ocean Service
NW - Notice Writer
OBSCU - Obscured
OBST - Obstruction
OBSTR - Obstruction
Oc - Occulting
ODAS - Anchored Oceanographic Data Buoy

RIV - River
RRASS - Remote Radio Activated Sound Signal
s - seconds
SEC - Section
SHL - Shoaling
si - silent
SIG - Signal
SND - Sound
SPM - Single Point Mooring Buoy
SS - Sound Signal
STA - Station
STRUCT - Structure
St M - Statute Mile
TEMP - Temporary Aid Change
TMK - Topmark
TRLB - Temporarily Replaced by Lighted Buoy
TRLT - Temporarily Replaced by Light
TRUB - Temporarily Replaced by Unlighted Buoy
USACE - Army Corps of Engineers
W - White
Y - Yellow

Additional Abbreviations Specific to this LNM Edition:

SNNE- U.S. Coast Guard Sector Northern New England
SBOS- U.S. Coast Guard Sector Boston
SSENE- U.S. Coast Guard Sector Southeastern New England
SLIS- U.S. Coast Guard Sector Long Island Sound
SNEW- U.S. Coast Guard Sector New York

AIS - Automatic Identification System
AtoN - Aids to Navigation
LLNR - Light List Number
NM - Nautical Mile

SECTION I - SPECIAL NOTICES

This section contains information of special concern to the Mariner.

U.S. Coast Pilot 3-NEW EDITION

PUBLICATION—National Oceanic Atmospheric Administration (NOAA) – U.S. Coast Pilot 3, Atlantic Coast:
Sandy Hook, NJ to Cape Henry, VA, 56th Edition, 2023, has been issued and is ready for free download and weekly updates at

www.nauticalcharts.noaa.gov/publications/coast-pilot/index.html.

Only Print-on-Demand (POD) bound copies are available for purchase; visit

www.nauticalcharts.noaa.gov/publications/print-agents.html#coast-pilot

The 2023 Edition cancels the preceding 2022 Edition, and incorporates all previous corrections.

LNM: 51/22

CAUTION TO BE USED IN RELIANCE UPON AIDS TO NAVIGATION

The aids to navigation depicted on charts comprise a system of fixed and floating aids with varying degrees of reliability. Therefore, prudent mariners will not rely solely on any single aid to navigation, particularly a floating aid. With respect to buoys, the buoy symbol is used to indicate the approximate position of the buoy body and the sinker, which secures the buoy to the seabed. The approximate position is used because of practical limitations in positioning and maintaining buoys and their sinkers in precise geographical locations. These limitations include, but are not limited to, inherent imprecision's in position fixing methods, prevailing atmospheric and sea conditions, the slope of and the material making up the seabed, the fact that buoys are moored to sinkers by varying lengths of chain, and the fact that buoy body and/or sinker positions are not under continuous surveillance but are normally checked only during periodic maintenance visits which often occur more than a year apart. The position of the buoy body can be expected to shift inside and outside the charting symbol due to the forces of nature. The mariner is also cautioned that buoys are liable to be carried away, shifted, capsized, sunk, etc. Lighted buoys may be extinguished or sound signals may not function as the result of ice, running ice or other natural causes, collisions, or other accidents. For the foregoing reasons, a prudent mariner must not rely completely upon the position or operation of floating aids to navigation, but will also utilize bearings from fixed objects and aids to navigation on shore. Further, a vessel attempting to pass close aboard always risks collision with a yawing buoy or with the obstruction the buoy marks.

LNM: 29/22

INTERFERENCE WITH AIDS TO NAVIGATION

14 USC 543. It shall be unlawful for any person, or public body, or instrumentality, excluding the armed forces, to remove, change the location of, obstruct, willfully damage, make fast to, or interfere with any aid to navigation established, installed, operated, or maintained by the Coast Guard pursuant to section 541 of this title, or with any aid to navigation lawfully maintained under authority granted by the Coast Guard pursuant to section 542 of this title, or to anchor any vessel in any of the navigable waters of the United States so as to obstruct or interfere with range lights maintained therein. Whoever violates the provisions of this section shall be guilty of a misdemeanor and shall be fined not more than \$1,500 for each offense. Each day during which such violation shall continue shall be considered as a new offense.

LNLM: 29/22

U.S. COAST GUARD AUXILIARY – PUBLIC EDUCATION CLASSES – FIND BY ZIPCODE

The National Public Education Calendar Database provides a single, unified national database that holds and displays all public education courses taught by our various flotillas nationwide. In addition, a Zip Code search permits members of the general public to enter a Zip Code of interest, and find all public education courses being taught within a selected distance from that Zip Code.
http://www.cgaux.org/boating/class_finder/index.php

LNLM: 29/22

ME, NH, MA, RI, CT, NY, NJ-ATLANTIC OCEAN-OFFSHORE STRUCTURE PATON MARKING GUIDANCE-Revised, Updated 28 Sep 2022 to reflect FCC AIS device requirement and ESP labling identification

For Private Aids to Navigation (AtoN) applicants requesting Coast Guard permits to provide navigational markings on offshore wind energy area structures in First District-area waters, the following structure identification, lighting, sound signal, and Automated Identification System (AIS) capabilities are strongly recommended. Applicants should plan to apply for one Private Aid Permit per structure (to include all labels, light(s), sound signals and AIS signals). Private AtoN Permit applications should be submitted no sooner than 60 days prior to the need to activate a structure's final markings. Additional specific recommendations include:

Tower/Electrical Service Platform (ESP) Identification:

- Uniquely lettered and numbered in an organized pattern as near to rows and columns as possible to maximize charting effectiveness
- (Tower) Letters and numbers labelled to as near to 3 meters high as possible to maximize visual range for nearby mariners
- (ESP) Letters and numbers labelled to 1 meter high to maximize visual range for nearby mariners
- Visible above any servicing platforms
- Visible throughout a 360-degree arc from the water's surface
- Visible at night through use of retro-reflective paint and lettering/numbering materials is strongly recommended
- If feasible, also labelled below the servicing platform

Lighting:

- Located on all structures, preferably on the servicing platform, visible throughout a 360-degree arc from the water's surface
- Corner Towers/Significant Peripheral Structures (SPSs): Quick flashing yellow (QY, 0.3s on/0.7s off, 60 flashes per minute) energized at a five nautical mile range
- Outer Boundary Towers: Yellow 2.5 sec (FL Y 2.5s, 1.0s on 1.5s off, 12 flashes per minute) energized at three nautical mile range
- Interior Towers: Yellow 6 sec or yellow 10 sec (FL Y 6, 1.0s on 5.0s off, 10 flashes per minute/FL Y 10, 1.0s on 9s off, 6 flashes per minute) energized at a two nautical mile range
- All lights should be synchronized by their structure location within the field of structures

Note: All temporary base, tower and construction components preceding the final structure completion must be marked with Quick Yellow (QY) obstruction lights visible throughout 360 degrees at a distance of 5NM. These do not require permits, only Coast Guard notification for appropriate marine notices and broadcasts until the final structure marking is established.

Sound Signals:

- Should be located on all structures located at corners/SPSs
- Sound every 30 seconds (4s Blast, 26s off)
- Set to project at a 2NM range
- Should not exceed 3NM spacing between perimeter structures
- Must be Mariner Radio Activated Sound Signal (MRASS) activated by keying VHF Radio frequency 83A five times within ten seconds
- Timed to energize for 45 minutes from last VHF activation

Automated Information System (AIS) Transponder Signals:

- Must be FCC-certified AIS Aids to Navigation device at the following link: <https://apps.fcc.gov/oetcf/eas/reports/GenericSearch.cfm>
- Must be transmitted superimposed at all corner structures/SPSs
- Should be capable of transmitting signals to mark all locations of all structures throughout an established field
- Must be approved at the Coast Guard Headquarters level (CG-NAV) based on the First Coast Guard District's recommendation

PATON Application Website: WWW.USHARBORMASTER.COM .

Please forward questions or feedback in an e-mail to:
D01-SMB-DPWPUBLICCOMMENTS@USCG.MIL.

Charts: 13003 13006 13009 13200

LNLM: 33/20

**** CANCELLATION OF NOAA PAPER AND RASTER NAUTICAL CHARTS****

CANCELLATION OF NOAA PAPER AND RASTER NAUTICAL CHARTS

The National Oceanic and Atmospheric Administration (NOAA) is undertaking a multi-year program to end production and maintenance of its suite of over 1,000 traditional paper nautical charts and all associated raster chart products and services, including: Print-on-Demand (POD) paper nautical charts, Full-size chart PDF files, BookletChart™ PDF files, NOAA raster navigational charts (NOAA RNC®), the NOAA RNC tile service, and the online RNC viewer.

Six months notice of the intent to cancel a specific chart is provided in a "Last Edition" notice. The final cancellation of a chart is made in a "Canceled" notice. Both types of notices will appear in LNM Section IV, "Chart Correction." A comprehensive list of all canceled NOAA charts is available at: <http://www.charts.noaa.gov/MCD/Dole.shtml>.

Traditional paper nautical chart production is ending to enable the creation and maintenance of larger scale, more up-to-date, higher quality coverage of NOAA's electronic navigational chart (NOAA ENC®) product. This will significantly enhance the amount of charted detail available to mariners. More information about NOAA's program to sunset traditional paper charts is on the NOAA Coast Survey website at: <https://nauticalcharts.noaa.gov/charts/farewell-to-traditional-nautical-charts.html>

An online NOAA Custom Chart application at: <https://devgis.charttools.noaa.gov/pod> is available to create chart images from ENC data, which may then be printed. Notices to Mariners will not be issued for NOAA Custom Charts.

LNM: 11/21

SAFETY NOTICE - NAVIGATIONAL RANGE AND SECTOR LIGHTS ON ELECTRONIC CHARTS

The U.S. Coast Guard has become aware that the Range and Sector Light Characteristic labels are not displayed on Electronic Navigational Charts (ENCs) when used in an Electronic Chart Display and Information System (ECDIS) due to limitations of the S-52 ECDIS display specification. Mariners may query the ENC data directly within ECDIS or refer to the Light List for complete information on Range and Sector Light Characteristics.

LNM: 39/22

NOTICE TO ALL PRIVATE BOATS AT SEA

United States laws and regulations require that ALL private boats arriving from a foreign port or place MUST report to the Bureau of Customs and Border Protection IMMEDIATELY upon their arrival into the United States. Every person entering the United States must be seen in person for immigration purposes by a Customs and Border Protection officer, except those participating in the I-68 -Canadian Border Boat Landing Program. However, holders of form I-68 are still required to report their arrival into the United States to the Bureau of Customs and Border Protection. Masters and passengers must provide proof of citizenship or legal immigration status, and be in possession of a valid passport and visa, if required. Citizens of countries that are participants in the Visa Waiver Program are not eligible to seek admission to the United States under that program via private vessel. Once your boat is anchored or tied, you are considered to have entered the United States. No one may leave the vessel until Customs and Border Protection grants permission. The only exception to this requirement is to report arrival. In order to fulfill the requirement to immediately report a private boat arrival, the master of the vessel must contact the nearest Customs and Border Protection Office, or if the arrival occurs after business hours, the nearest 24 hour port of entry. Upon reporting, you may be required to proceed to a staffed port for inspection by Customs and Border Protection. Failure to comply with these requirements could result in serious criminal and civil penalties, including seizure of the boat. International mariners are urged to report any suspicious or illegal activity to the Bureau of Customs and Border Protection at 1-800-BE-ALERT.

LNM: 13/18

NY/NJ – OPERATION CLEAR CHANNEL IN THE PORT OF NY/NJ

The Operation Clear Channel program is designed to educate boaters about the hazards of operating small vessels and personal watercraft in the confines of navigational channels used by larger commercial ships. Federal Navigation Rules, also known as the "Rules of the Road", address this safety concern by giving commercial vessels priority, or right-of-way, over smaller vessels when navigating in narrow channels. An average of 1,400 commercial vessels navigate the waters of the Port of NY/NJ every day and the masters of these vessels, while always on the lookout, cannot always see smaller vessels operating within the channels.

Recreational boaters should keep a sharp lookout and always be prepared to give way to ships constrained in their ability to maneuver, especially when operating within close proximity of a channel. U.S. Coast Guard units in New York and New Jersey actively promote boater awareness through vessel enforcement patrols and visits to local marinas. The U.S. Coast Guard focuses Operation Clear Channel efforts on high-traffic regions, such as Ambrose Channel, Sandy Hook Channel and Raritan Bay, but patrols all of New York Harbor in an effort to promote awareness. Mariners interested in increasing their knowledge of boating safety, including the "Rules of the Road", should consider a U.S. Coast Guard Auxiliary boating safety course. Course information is available online at <http://www.cgaux.org> in the "Take a Boating This free online educational resource for safe boating in the Port of NY & NJ is a cooperative effort by the I BOAT NJ program through NJ DOT and U.S. Coast Guard Sector New York. The project contains a feature length 26 minute safety video describing the challenges of the multi user Port environment and 5 sub chapters: Paddlers, Motor Boaters, Sailors, Pilots and Operation Clear Channel. Its mission is to increase safety and awareness in the Port and its target is recreational boaters who transit and operate in the PortCourse" section, or by calling 1-800-336-BOAT. Further information can be found at <http://thesafeharbor.us/index.html>

LNM: 13/18

US NOTICE TO MARINERS (NTM)

The US Notice to Mariners provides timely marine safety information for the correction of all US Government navigation charts and publications from a wide variety of sources both foreign and domestic. To ensure the safety of life at sea, the information published in the Notice to Mariners is designed to provide for the correction of unclassified nautical charts, the Unclassified NGA/DLIS Catalog of Hydrographic Products, United States Coast Pilots, NGA List of Lights, USCG Light Lists, and other related nautical publications produced by NGA, NOS and the U.S. Coast Guard. The US Notice to Mariners will contain only those chart corrections of interest to ocean going vessels. It is available online at http://msi.nga.mil/NGAPortal/MSI.portal?_nfpb=true&_pageLabel=msi_portal_page_61. NTM 01 – Special Paragraphs includes information on: America’s Waterway Watch program asking those who work, live, or recreate on or near the water to be aware of suspicious activity, The Prudent Mariner and the use of floating Aids to Navigation, and Northern Right Whales.

LNM: 13/18

SECTION II - DISCREPANCIES

This section lists all reported and corrected discrepancies related to Aids to Navigation in this edition. A discrepancy is a change in the status of an aid to navigation that differs from what is published or charted.

DISCREPANCIES (FEDERAL AIDS)

LLNR	Aid Name	Status	Chart No.	BNM Ref.	LNM St	LNM End
35	Seguin Light	LT IMCH	13295	SNNE-072-22	23/22	
60	Cape Elizabeth Light	SS IMCH	13292	SNNE-005-23	02/23	
425	Boston Light	SS INOP	13270	SBOS-002-23	02/23	
1145	Avery Rock Light AR	DAYMK MISSING	13326	SNNE-139-20	44/20	
1485	Salt Rock Daybeacon 4	MISSING	13326	SNNE-155-22	49/22	
1925	Grindstone Ledge Daybeacon	LT IMCH/STRUCT DMGD	13322	SNNE-086-22	28/22	
1955	Pulpit Ledge Daybeacon 3	MISSING/STRUCT DEST/HAZ NAV	13322	SNNE-087-22	28/22	
2230	Southwest Harbor Daybeacon S	DAYMK MISSING	13321	SNNE-004-23	02/23	
2295	Great Duck Island Light	LT EXT/SS INOP	13313	SNNE-073-22	23/22	
2325	Black Island Buoy 2	HAZ NAV/BUOY DMGD	13313	SNNE-169-22	01/23	
2340	Bass Harbor Head Bell Buoy EB	OFF STA/HAZ NAV	13313	SNNE-163-22	52/22	
3307	Three Fathom Ledge Isolated Danger Lighted Buoy DTF	OFF STA/HAZ NAV	13303	SNNE-165-22	52/22	
4100	Drunkard Ledge Daybeacon	DAYMK IMCH	13308	SNNE-037-18	11/18	
4115	Shag Rock Daybeacon 9	STRUCT DEST/DAYMK MISSING	13307	SNNE-016-22	05/22	
4240	Rockland Harbor Town Channel Buoy 3	OFF STA/HAZ NAV	13307	SNNE-162-22	52/22	
4270	Porterfield Ledge Daybeacon	DAYMK DMGD	13307	SNNE-089-20	30/20	
5260	Hypocrite Ledge Daybeacon H	DAYMK DMGD	13293	SNNE-079-20	28/20	
5590	Seguin Light	LT IMCH	13295	SNNE-072-22	23/22	
6720	Merriconeag Sound Approach Daybeacon 10	DAYMK IMCH	13290	SNNE-044-19	35/17	
7520	Cape Elizabeth Light	SS IMCH	13292	SNNE-005-23	02/23	
7525	Broad Cove Rock Buoy 5	OFF STA/HAZ NAV	13292	SNNE-164-22	52/22	
8120	Goat Island Daybeacon 8	MISSING/HAZ NAV	13286	SNNE-167-22	01/23	
8155	Fishing Rock Daybeacon F	DAYMK MISSING	13286	SNNE-043-19	19/17	
8515	Piscataqua River Buoy 12	MISSING/HAZ NAV	13285	SNNE-001-23	02/23	
8875	Rye Harbor Buoy 3	MISSING/HAZ NAV	13283	SNNE-166-22	52/22	
9340	Bass Rock Daybeacon BR	DAYMK MISSING	13282	SBOS-075-22	34/22	
9840	Dodge Rock Daybeacon 2	MISSING/HAZ NAV	13279	SBOS-118-21	45/21	
9990	Whaleback Daybeacon 8	DAYMK MISSING/STRUCT DMGD	13275	SBOS-089-22	41/22	
10025	Bowditch Ledge Daybeacon	STRUCT DEST	13276	SBOS-185-18	47/18	
10065	Abbot Rock Daybeacon	STRUCT DEST/HAZ NAV/DAYMK MISSING	13276	SBOS-126-19	43/19	
10265	Lobster Rocks Daybeacon 13A	STRUCT DEST/DAYMK MISSING	13276	SBOS-139-19	48/19	
10890	Boston Main Channel Light 5	LT IMCH	13272	SBOS-080-22	05/22	

11340	Boston Light	SS INOP	13270	SBOS-002-23	02/23
11650	Windmill Point Light WP	SS INOP	13270	SBOS-003-22	02/23
13780	Alleghany Rock Buoy 25	MISSING	13238	SENE-238-22	01/23
16090	Cleveland Ledge Channel Range Rear Light	REDUCED INT	13236	SENE-155-22	23/22
16120	Cleveland Ledge Channel Lighted Buoy 7	LT EXT	13236	SENE-236-22	01/23
17500	Westport Harbor Channel Buoy 16	OFF STA/HAZ NAV	13228	SENE-006-23	02/23
19720	Block Island Old Harbor Channel Breakwater Light 3	SS IMCH	13217	None	02/23
19815	Race Rock Light	LT EXT	13212	SLIS-238-22	50/22
19815	Race Rock Light	LT EXT	13212	SLIS-245-22	52/22
21185	Branford Reef Light	DAYMK DMGD	12373	SLIS-120-22	25/22
21840	Frank Ledge Buoy F	BUOY DMGD	13213	SLIS-215-22	01/23
22940	Connecticut River Light 48	STRUCT DMGD/TRUB	12377	SLIS-238-18	48/18
24395	Housatonic River Channel Buoy 9	OFF STA	12369	SLIS-004-23	02/23
24670	Black Rock Daybeacon	DAYMK MISSING	12364	SLIS-082-21	25/21
27260	Brother Island Channel Buoy 8	OFF STA/HAZ NAV	12339	SNY-537-22	52/22
27415	Westchester Creek Channel Buoy 2	MISSING	12339	SNY-008-23	02/23
29135	Fire Island Inlet Lighted Buoy 6	MISSING/HAZ NAV	12352	SLIS-242-22	52/22
29145	Fire Island Inlet Lighted Buoy 8	OFF STA/HAZ NAV	12352	SLIS-237-22	50/22
29325	East Channel Buoy 27	OFF STA/HAZ NAV	12352	SLIS-241-22	52/22
31075	Sloop Channel Lighted Buoy 15	OFF STA/HAZ NAV	12352	SLIS-005-23	02/23
31130	State Boat Channel Light 4	DAYMK MISSING	12352	None	52/22
31530	East Rockaway Inlet Lighted Buoy 5	OFF STA/HAZ NAV	12350	SLIS-247-22	33/22
31535	East Rockaway Inlet Lighted Buoy 6	OFF STA/HAZ NAV	12350	SLIS-173-22	33/22
35095	Sandy Hook Channel Lighted Buoy 2	HAZ NAV/LT EXT	12401	SNY-006-23	02/23
35660	Naval Weapon Station Earle Security Zone Lighted Buoy 1	LT EXT	12401	SNY-038-20	17/20
35710	Compton Channel Buoy 6	MISSING/HAZ NAV	12401	SNY-532-22	51/22
36290	Raritan Bay Channel Lighted Buoy 53	OFF STA/HAZ NAV	12331	SNY-003-22	01/23
37370	Kill Van Kull Channel Buoy 24	MISSING/HAZ NAV	12333	SNY-533-22	52/22
38435	Silver Point Range Rear Light	LT EXT	12347	SNY-517-22	49/22

DISCREPANCIES (FEDERAL AIDS) CORRECTED

LLNR	Aid Name	Status	Chart No.	BNM Ref.	LNM St	LNM End
425	Boston Light	WATCHING PROPERLY	13270	SBOS-102-22	01/23	02/23
4130	Rockland Harbor Breakwater Light	WATCHING PROPERLY	13307	SNNE-170-22	02/23	02/23
11340	Boston Light	WATCHING PROPERLY	13270	SBOS-102-22	01/23	02/23
13050	Cape Cod Canal Breakwater Light 6	WATCHING PROPERLY	13236	SENE-002-23	02/23	02/23
18310	Providence River Channel Lighted Buoy 15	WATCHING PROPERLY	13224	SENE-178-22	36/22	02/23
18330	Providence River Channel Lighted Buoy 19	WATCHING PROPERLY	13224	SENE-003-23	02/23	02/23
18435	Providence River Channel Lighted Buoy 23	WATCHING PROPERLY	13224	SENE-004-23	02/23	02/23
21210	Southwest Ledge Light	WATCHING PROPERLY	12371	SLIS-003-22	02/23	02/23
22905	Connecticut River Range A Rear Light	WATCHING PROPERLY	12377	None	49/22	02/23
24060	Southwest Ledge Light	WATCHING PROPERLY	12371	SLIS-003-22	02/23	02/23
25085	Fivemile River Entrance Lighted Buoy 3	WATCHING PROPERLY	12368	SLIS-246-22	52/22	02/23
26680	Northport Bay Entrance Lighted Buoy 1	WATCHING PROPERLY	12365	SLIS-001-23	01/23	02/23
27420	Westchester Creek Channel Buoy 3	WATCHING PROPERLY	12339	SNY-525-22	50/22	02/23
27510	Flushing Bay Channel Buoy 11	WATCHING PROPERLY	12339	SNY-539-22	01/23	02/23

27560	Bronx River Channel Buoy 3	WATCHING PROPERLY	12339	SNY-387-22	32/22	02/23
27585	Bronx River Channel Buoy 8	WATCHING PROPERLY	12339	SNY-484-22	42/22	02/23
30330	Moriches Bay Lighted Buoy 24	WATCHING PROPERLY	12352	SENE-002-23	02/23	02/23
37275	Kill Van Kull Channel Lighted Buoy 7	WATCHING PROPERLY	12334	SNY-001-23	01/23	02/23
37335	Kill Van Kull Channel Lighted Buoy 18	WATCHING PROPERLY	12333	SNY-544-22	01/23	02/23
38350	Hudson River Light 86	WATCHING PROPERLY	12347	SNY-007-22	02/23	02/23

DISCREPANCIES (PRIVATE AIDS)

LLNR	Aid Name	Status	Chart No.	BNM Ref.	LNM St	LNM End
297	NEMAC/Salem State University Aquaculture Lighted Buoy A	MISSING/HAZ NAV	13278	SBOS-023-22	16/22	
305	Thacher Island North Light	LT IMCH	13279	SBOS-066-22	31/22	
368	Neptune LNG Deepwater Port Lighted Buoy North A1	LT EXT	13274	SBOS-063-22	30/22	
466	WHOI Traffic Separation Scheme Research Lighted Buoy AB-2	OFF STA	13274	None	18/21	
498	WHOI Traffic Separation Scheme Research Lighted Buoy AB-10	OFF STA/HAZ NAV	13246	SENE-0159-21	28/21	
510.1	Nauset Beach Light	LT EXT	13246	SENE-217-21	38/21	
589	WHOI Research Light Tower	SS INOP	13233	SENE-015-22	04/22	
654.5	Block Island Wind Farm WTG-3 Fog Horn	SS INOP	13215	None	34/22	
5402	Damariscotta River Buoy 28	OFF STA/HAZ NAV	13293	SNNE-124-22	37/22	
7740	Mill Cove Daybeacon 1	LT IMCH	13292	SNNE-084-22	27/22	
11020	Island End River Daybeacon 6	DAYMK MISSING	13272	SBOS-0057-21	25/21	
11441	Georges Island Lighted Hazard Buoy A	MISSING/HAZ NAV	13270	SBOS-0079-21	32/21	
13037	WHG Research Lighted Buoy W NERACOOS 44090	OFF STA/HAZ NAV	13246	SENE-202-22	40/22	
15510	Lagoon Pond Daybeacon 8	DAYMK MISSING	13238	None	16/20	
16480	Fiddlers Cove Marina Buoy 5FC	OFF STA/HAZ NAV	13236	SENE-0184-20	47/20	
16926.6	New Bedford South Terminal Buoy 7	OFF STA/HAZ NAV	13232	SENE-0204-21	36/21	
18113	NEBW Daybeacon 1	STRUCT DEST	13223	SENE-0134-21	25/21	
18192	Bristol Harbor Daybeacon 6A	DAYMK MISSING	13224	SENE-198-22	40/22	
18194	Bristol Harbor East Channel Buoy 5	OFF STA/HAZ NAV	13224	SENE-192-22	40/22	
18196	Bristol Harbor West Channel Buoy 1	OFF STA	13224	SENE-194-22	08/22	
18930	Braga Bridge Sound Signal	SS INOP	13221	SENE-001-23	02/23	
19275	Quonset Point Terminal Approach Buoy EB-B	MISSING	13223	SENE-0131-22	26/22	
20345	Pawcatuck River Channel Daybeacon 19	MISSING	13214	SLIS-0057-21	20/21	
22565	Old Saybrook North Cove Buoy 2	MISSING/HAZ NAV	12375	SLIS-0083-20	24/20	
23385	Menunketesuck Island Shoal Buoy	OFF STA/HAZ NAV/SINKING/TRUB	12374	SLIS-201-22	34/22	
23513	Clinton Harbor Channel Buoy 15	OFF STA	12374	SLIS-119-22	25/22	
25380	Sugar Boat Buoy 2A	MISSING	12367	None	11/21	
27000	Oyster Bay Harbor Inner Channel Lighted Buoy 4B	REDUCED INT	12365	None	03/20	
27145	Tom Point Inner Buoy 5	MISSING/HAZ NAV	12366	SNY-120-20	17/20	
27150	Tom Point Outer Buoy 6	MISSING/HAZ NAV	12366	SNY-120-20	17/20	
27246.2	East River Regulatory Light C	STRUCT DEST	12339	None	11/21	
27246.4	East River Regulatory Light E	OFF STA/HAZ NAV	12339	None	11/21	
27547	La Guardia Airport Security Zone Lighted Buoy A	OFF STA	12339	SNY-438-21	11/21	
27547.1	La Guardia Airport Security Zone Lighted Buoy B	MISSING	12339	None	11/21	
27547.2	La Guardia Airport Security Zone Lighted Buoy C	OFF STA	12339	None	11/21	

27547.3	La Guardia Airport Security Zone Lighted Buoy D	OFF STA	12339	None	11/21
27547.4	La Guardia Airport Security Zone Lighted Buoy E	MISSING	12339	None	11/21
27547.5	La Guardia Airport Security Zone Lighted Buoy F	MISSING	12339	None	11/21
27547.6	La Guardia Airport Security Zone Lighted Buoy G	MISSING	12339	None	11/21
27547.7	La Guardia Airport Security Zone Lighted Buoy H	MISSING	12339	None	11/21
27547.8	La Guardia Airport Security Zone Lighted Buoy I	MISSING	12339	None	11/21
27639	La Guardia Outfall Lighted Hazard Buoy 006	MISSING	12339	None	11/21
27653.3	La Guardia Airport Security Zone Light F	OFF STA	12339	None	11/21
28200	Coecles Harbor Lighted Buoy 1	OFF STA/HAZ NAV	12358	SLIS-188-22	37/22
29550	East-West Channel Buoy 17	OFF STA/HAZ NAV	12352	SLIS-089-21	26/21
30126	Bellport Beach Channel Buoy 9	OFF STA/HAZ NAV	12352	SLIS-146-21	39/21
30223	Pattersquash Creek Lighted Buoy 2	BUOY DMGD/LT EXT	12352	None	38/21
33780	North Channel Light 18	LT EXT/DAYMK MISSING	12352	SLIS-111-22	24/22
33790	North Channel Light 20	LT EXT/DAYMK MISSING	12352	SLIS-111-22	24/22
33795	North Channel Light 22	LT EXT/DAYMK MISSING	12352	SLIS-159-22	24/22
34075	Amity Channel Light 94	OFF STA/HAZ NAV	12352	SLIS-124-22	26/22
34200	Massapequa Cove Daybeacon 4	DAYMK DMGD	12352	None	15/22
34335	Outfall Gate House Light	MISSING	12350	SNY-385-20	47/20
35006	Ellis Island Security Zone Buoy ELSZ1	MISSING	12334	SNY-167-21	24/21
35006.1	Ellis Island Security Zone Buoy ELSZ2	MISSING/HAZ NAV	12334	SNY-168-21	24/21
35006.6	Ellis Island Security Zone Buoy ELSZ7	MISSING/HAZ NAV	12334	SNY-169-21	24/21
35006.9	Ellis Island Security Zone Buoy ELSZ10	MISSING/HAZ NAV	12334	SNY-170-21	24/21
35025	Highlands Light	LT IMCH	12324	SNY-381-20	46/20
35560	Leonardo Channel Buoy 1	MISSING/HAZ NAV	12401	None	17/20
36680	Maurer Rock Lighted Buoy B	OFF STA/HAZ NAV	12331	SNY-307-22	28/22
37247.1	Liberty Island Security Zone Buoy LISZ2	MISSING/HAZ NAV	12334	SNY-346-22	31/22
37247.2	Liberty Island Security Zone Buoy LISZ3	MISSING/HAZ NAV	12334	SNY-346-22	31/22
37374	Shooters Island South Channel Wreck Lighted Buoy WR1	MISSING/HAZ NAV	12333	SNY-152-20	22/20
37910	Greens Cove Channel Lighted Buoy 1	OFF STA/HAZ NAV	12343	SNY-035-22	04/22
	North Channel Light 22	LT EXT/DAYMK MISSING	12352	SLIS-159-22	24/22

DISCREPANCIES (PRIVATE AIDS) CORRECTED

LLNR	Aid Name	Status	Chart No.	BNM Ref.	LNM St	LNM End
14725	Spindle Rock Buoy 8	WATCHING PROPERLY	13229	SENE-180-22	36/22	02/23

SECTION III - TEMPORARY CHANGES and TEMPORARY CHANGES CORRECTED

This section contains temporary changes and corrections to Aids to Navigation for this edition. When charted aids are temporarily relocated for dredging, testing, evaluation, or marking an obstruction, a temporary correction shall be listed in Section IV giving the new position.

TEMPORARY CHANGES

LLNR	Aid Name	Status	Chart No.	BNM Ref.	LNM St	LNM End
828	WHOI Research Lighted Buoy Pioneer PMUI	DISCONTINUED FOR DREDGING	12300	SENE-202-20	50/20	
5940	Sassanoa River Daybeacon 22	DISCONTINUED	13296	SNNE-052-22	15/22	
10505	Middle Ground Buoy 4	DISCONTINUED	13275	SBOS-078-22	34/22	
10897	Boston Main Channel Lighted Buoy 5A	RELOCATED FOR DREDGING	13272	SBOS-085-21	33/21	
10910	Boston Main Channel Lighted Buoy 10	RELOCATED FOR DREDGING	13272	SBOS-084-21	33/21	
12275	Old Scituate Light	DISCONTINUED	13269	NONE	38/22	
14540	Hyannis Harbor Breakwater Light H	TRLB	13229	SENE-027-22	09/22	
14780	Wreck Shoal Lighted Bell Buoy 8	DISCONTINUED	13229	SENE-197-22	40/22	
15370	Muskeget Channel Buoy 4	DISCONTINUED	13233	SENE-195-22	40/22	
15380	Muskeget Channel Buoy 6	DISCONTINUED	13233	SENE-196-22	40/22	
19535	Great Island Channel Buoy 1	DISCONTINUED FOR DREDGING	13205	SENE-216-22	48/22	
19540	Great Island Channel Buoy 3	DISCONTINUED FOR DREDGING		SENE-216-22	48/22	
19545	Great Island Channel Buoy 5	DISCONTINUED FOR DREDGING	13219	SENE-220-22	48/22	
19800	URI Coastal Monitoring Lighted Research Buoy	DISCONTINUED	13215	NONE	38/20	
20367	Pawcatuck River Channel Daybeacon 23	DISCONTINUED FOR DREDGING	13214	SLIS-206-15	18/15	
21325	Eatons Neck Light	DISCONTINUED	12365	SLIS-049-22	10/22	
23740	Guilford Harbor Channel Buoy 9	DISCONTINUED FOR DREDGING	12373	SLIS-235-22	49/22	
23745	Guilford Harbor Channel Buoy 10	DISCONTINUED FOR DREDGING	12373	SLIS-235-22	49/22	
23750	Guilford Harbor Channel Buoy 11	DISCONTINUED FOR DREDGING	12373	SLIS-235-22	49/22	
23755	Guilford Harbor Channel Buoy 12	DISCONTINUED FOR DREDGING	12373	SLIS-235-22	49/22	
23765	Guilford Harbor Channel Buoy 14	DISCONTINUED FOR DREDGING	12373	SLIS-235-22	49/22	
27756	Acabonack Harbor Entrance Buoy 1	DISCONTINUED FOR DREDGING	13209	NONE	20/20	
27756.5	Acabonack Harbor Entrance Buoy 2	DISCONTINUED FOR DREDGING	13209	NONE	20/20	
27757	Acabonack Harbor Entrance Buoy 3	DISCONTINUED FOR DREDGING	13209	NONE	20/20	
27757.5	Acabonack Harbor Entrance Buoy 4	DISCONTINUED FOR DREDGING	13209	NONE	20/20	
30300	Moriches Bay Buoy 17	DISCONTINUED	12352	SLIS-0015-21	08/21	
30303	Moriches Bay Buoy 17A	DISCONTINUED	12352	SLIS-0015-21	08/21	
30305	Moriches Bay Lighted Buoy 18	DISCONTINUED	12352	SLIS-0015-21	08/21	
30315	Moriches Bay Buoy 21	DISCONTINUED	12352	NONE	10/21	
30320	Moriches Bay Buoy 20	DISCONTINUED	12352	SLIS-0015-21	08/21	
30331	Hart Cove Buoy 1	DISCONTINUED	12352	SLIS-0048-19	14/19	
30331.2	Hart Cove Buoy 2	DISCONTINUED	12352	SLIS-0048-19	14/19	
30331.3	Hart Cove Buoy 3	DISCONTINUED	12352	SLIS-0048-19	14/19	
30331.5	Hart Cove Buoy 5	DISCONTINUED	12352	SLIS-0048-18	14/19	
30331.7	Hart Cove Buoy 7	DISCONTINUED	12352	SLIS-0048-19	14/19	
30331.8	Hart Cove Buoy 8	DISCONTINUED	12352	SLIS-0048-19	14/19	
30331.9	Hart Cove Buoy 9	DISCONTINUED	12352	SLIS-0048-19	14/19	

30332	Hart Cove Buoy 10	DISCONTINUED	12352	SLIS-0048-19	14/19
30332.2	Hart Cove buoy 12	DISCONTINUED	12352	SLIS-0048-19	14/19
30332.4	Hart Cove Buoy 14	DISCONTINUED	12352	SLIS-0048-19	14/19
30335	Moriches Bay Buoy 26	DISCONTINUED	12352	NONE	10/22
30340	Moriches Bay Buoy 27	DISCONTINUED	12352	NONE	19/20
30341	Moriches Bay Buoy 28	DISCONTINUED	12352	NONE	19/20
30365	Moriches Bay Lighted Buoy 29	DISCONTINUED	12352	NONE	19/20
30933	Jones Inlet Hazard Buoy	DISCONTINUED FOR DREDGING	12352	SLIS-202-22	41/22
30935	Jones Inlet Lighted Buoy 6	DISCONTINUED FOR DREDGING	12352	SLIS-202-22	41/22
30940	Jones Inlet Lighted Buoy 7	DISCONTINUED FOR DREDGING	12352	SLIS-202-22	41/22
30950	Jones Inlet Buoy 9	DISCONTINUED FOR DREDGING	12352	SLIS-202-22	41/22
30951	Jones Inlet Buoy 11	DISCONTINUED FOR DREDGING	12352	SLIS-202-22	41/22
30955	Jones Inlet Buoy 12	DISCONTINUED FOR DREDGING	12352	SLIS-204-22	42/22
30975	Jones Inlet Lighted Buoy 16	DISCONTINUED FOR DREDGING	12352	SLIS-204-22	42/22
31540	East Rockaway Inlet Buoy 7	DISCONTINUED FOR DREDGING	12350	SLIS-234-22	01/23
31560	East Rockaway Inlet Buoy 12	DISCONTINUED FOR DREDGING	12350	SLIS-234-22	01/23
35110	Sandy Hook Channel Lighted Buoy 5	RELOCATED FOR DREDGING	12401	SNY-327-22	30/22
35125	Sandy Hook Channel Lighted Buoy 7	RELOCATED FOR DREDGING	12324	SNY-337-22	31/22
35157	Sandy Hook Channel Lighted Buoy 11A	DISCONTINUED FOR DREDGING	12401	SNY-391-21	43/21
35165	Sandy Hook Channel Lighted Gong Buoy 13	RELOCATED FOR DREDGING	12401	SNY-328-22	30/22
35180	Sandy Hook Channel Lighted Bell Buoy 18	RELOCATED FOR DREDGING	12401	SNY-338-22	31/22
35685	Naval Weapon Station Earle Security Zone Lighted Buoy 6	RELOCATED FOR DREDGING	12401	SNY-340-22	31/22
36985	Buttermilk Channel Entrance Lighted Gong Buoy 1	RELOCATED FOR DREDGING	12334	NONE	26/22
36990	Buttermilk Channel Buoy 5	RELOCATED FOR DREDGING	12334	NONE	26/22
37590	Hackensack River Buoy 15	DISCONTINUED	12337	SNY-503-22	46/22
37800	Hudson River Light 21	DISCONTINUED	12343	SNY-382-22	42/22
	Milton Harbor Buoy 10	DISCONTINUED FOR DREDGING	12367	SNY-431-21	52/21
	Milton Harbor Buoy 11	DISCONTINUED FOR DREDGING	12367	SNY-137-22	15/22
	Milton Harbor Buoy 12	DISCONTINUED FOR DREDGING	12367	SNY-253-22	23/22
	Milton Harbor Buoy 13	DISCONTINUED FOR DREDGING	12367	SNY-253-22	23/22
	Milton Harbor Buoy 14	DISCONTINUED FOR DREDGING	12367	SNY-235-22	23/22
	Milton Harbor Buoy 5	DISCONTINUED FOR DREDGING	12367	SNY-253-22	23/22
	Milton Harbor Buoy 6	DISCONTINUED FOR DREDGING	12367	SNY-253-22	23/22
	Milton Harbor Buoy 8	DISCONTINUED FOR DREDGING	12367	SNY-137-22	15/22
	Milton Harbor Buoy 9	DISCONTINUED FOR DREDGING	12367	SNY-434-21	52/21

SECTION IV - CHART CORRECTIONS

This section contains corrections to federally and privately maintained Aids to Navigation, as well as NOS corrections.

This section contains corrective actions affecting chart(s). Corrections appear numerically by chart number, and pertain to that chart only. It is up to the mariner to decide which chart(s) are to be corrected. The following example explains individual elements of a typical chart correction.

Chart Number	Chart Edition	Edition Date	Last Local Notice to Mariners	Horizontal Datum Reference	Source of Correction	Current Local Notice to Mariners
12327	91st Ed.	19-APR-97	Last LNM: 26/97	NAD 83		27/97
Chart Title: NY-NJ-NEW YORK HARBOR - RARITAN RIVER						
Main Panel 2245 NEW YORK HARBOR						
(Temp) ADD		NATIONAL DOCK CHANNEL BUOY 3			CGD01 at 40-41-09.001N	074-02-48.001W
Corrective Action	Green can	Object of Corrective Action			Position	

(Temp) indicates that the chart correction action is temporary in nature. Courses and bearings are given in degrees clockwise from 000 true. Bearings of light sectors are toward the light from seaward. The nominal range of lights is expressed in nautical miles (NM) unless otherwise noted.

12300	49th Ed.	01-JUN-12	Last LNM: 38/20	NAD 83		02/23
<i>Chart Title: Approaches to New York, Nantucket Shoals to Five Fathom Bank</i>						
Main Panel 666 NY APPROACHES - NANTUCKET SHOALS TO FIVE FATHOM BANK. Page/Side: N/A						
(Temp) ADD		Sub surface ODAS L25.			CGD01 at 41-03-45.180N	070-28-27.768W
12324	37th Ed.	01-DEC-18	Last LNM: 39/22	NAD 83		02/23
<i>Chart Title: Intracoastal Waterway Sandy Hook to Little Egg Harbor</i>						
Main Panel 683 SANDY HOOK TO LITTLE EGG HARBOR NEW JERSEY --. Page/Side: -						
ADD		Lower Left of Chart: This is the Last Edition of this chart. It will be canceled on 05-Jul-23.			NOS	--
LAST EDITION		No new editions of chart 12324 will be published. It will be canceled on 05-Jul-23. Comparable or larger scale Electronic Navigational Chart (ENC) coverage is available. See "Cancellation of NOAA Paper and Raster Nautical Charts" in Section I of this LNM for details. A list of all canceled NOAA charts is at https://www.charts.noaa.gov/MCD/Dole.shtml .			NOS	--
12334	74th Ed.	01-JAN-20	Last LNM: 39/19	NAD 83		02/23
<i>Chart Title: New York Harbor Upper Bay and Narrows-Anchorage Chart</i>						
Main Panel 2238 NY HARBOR - UPPER BAY AND NARROWS ANCHORAGE --. Page/Side: -						
ADD		Symbol Obstruction PA (cable) depth unknown, Chart No. 1 K40.			CGD01 at 40-36-36.240N	074-03-02.040W
13209	28th Ed.	01-AUG-17	Last LNM: 25/20	NAD 83		02/23
<i>Chart Title: Block Island Sound and Gardiners Bay; Montauk Harbor</i>						
Main Panel 2149 BLOCK ISLAND SOUND AND GARDINERS BAY --. Page/Side: -						
ADD		Lower Left of Chart: This is the Last Edition of this chart. It will be canceled on 05-Jul-23.			NOS	--
					NOS	

LAST EDITION	No new editions of chart 13209 will be published. It will be canceled on 05-Jul-23. Comparable or larger scale Electronic Navigational Chart (ENC) coverage is available. See "Cancellation of NOAA Paper and Raster Nautical Charts" in Section I of this LNM for details. A list of all canceled NOAA charts is at https://www.charts.noaa.gov/MCD/Dole.shtml .	--	--
13214	30th Ed. 01-FEB-14 Last LNM: 46/20 NAD 83		02/23
<i>ChartTitle: Fishers Island Sound</i>			
Main Panel 2142 FISHERS ISLAND SOUND. Page/Side: N/A			
ADD	Lower Left of Chart: This is the Last Edition of this chart. It will be canceled on 05-Jul-23.	NOS --	--
LAST EDITION	No new editions of chart 13214 will be published. It will be canceled on 05-Jul-23. Comparable or larger scale Electronic Navigational Chart (ENC) coverage is available. See "Cancellation of NOAA Paper and Raster Nautical Charts" in Section I of this LNM for details. A list of all canceled NOAA charts is at https://www.charts.noaa.gov/MCD/Dole.shtml .	NOS --	--
13215	21st Ed. 01-AUG-14 Last LNM: 09/20 NAD 83		02/23
<i>ChartTitle: Block Island Sound Point Judith to Montauk Point</i>			
Main Panel 2141 BLOCK ISL SND-PT JUDITH TO MONTAUK PT CONN-RI-NY. Page/Side: A			
ADD	Lower Left of Chart: This is the Last Edition of this chart. It will be canceled on 05-Jul-23.	NOS --	--
LAST EDITION	No new editions of chart 13215 will be published. It will be canceled on 05-Jul-23. Comparable or larger scale Electronic Navigational Chart (ENC) coverage is available. See "Cancellation of NOAA Paper and Raster Nautical Charts" in Section I of this LNM for details. A list of all canceled NOAA charts is at https://www.charts.noaa.gov/MCD/Dole.shtml .	NOS --	--
13217	17th Ed. 01-AUG-13 Last LNM: 09/20 NAD 83		02/23
<i>ChartTitle: Block Island</i>			
Main Panel 2140 BLOCK ISLAND RI. Page/Side: N/A			
ADD	Lower Left of Chart: This is the Last Edition of this chart. It will be canceled on 05-Jul-23.	NOS --	--
LAST EDITION	No new editions of chart 13217 will be published. It will be canceled on 05-Jul-23. Comparable or larger scale Electronic Navigational Chart (ENC) coverage is available. See "Cancellation of NOAA Paper and Raster Nautical Charts" in Section I of this LNM for details. A list of all canceled NOAA charts is at https://www.charts.noaa.gov/MCD/Dole.shtml .	NOS --	--
13219	14th Ed. 01-JUN-14 Last LNM: 04/16 NAD 83		02/23
<i>ChartTitle: Point Judith Harbor</i>			
Main Panel 2138 PT JUDITH HARBOR RI. Page/Side: A			
ADD	Lower Left of Chart: This is the Last Edition of this chart. It will be canceled on 05-Jul-23.	NOS --	--
LAST EDITION	No new editions of chart 13219 will be published. It will be canceled on 05-Jul-23. Comparable or larger scale Electronic Navigational Chart (ENC) coverage is available. See "Cancellation of NOAA Paper and Raster Nautical Charts" in Section I of this LNM for details. A list of all canceled NOAA charts is at https://www.charts.noaa.gov/MCD/Dole.shtml .	NOS --	--
13228	13th Ed. 01-APR-16 Last LNM: 25/20 NAD 83		02/23
<i>ChartTitle: Westport River and Approaches</i>			
Main Panel 2126 WESTPORT RIVER AND APPROACHES. Page/Side: A			
ADD	Lower Left of Chart: This is the Last Edition of this chart. It will be canceled on 05-Jul-23.	NOS --	--
LAST EDITION	No new editions of chart 13228 will be published. It will be canceled on 05-Jul-23. Comparable or larger scale Electronic Navigational Chart (ENC) coverage is available. See "Cancellation of NOAA Paper and Raster Nautical Charts" in Section I of this LNM for details. A list of all canceled NOAA charts is at https://www.charts.noaa.gov/MCD/Dole.shtml .	NOS --	--
13235	7th Ed. 01-JUL-12 Last LNM: 38/19 NAD 83		02/23

ChartTitle: Woods Hole

Main Panel 2109 WOODS HOLE MA. Page/Side: N/A

ADD	Lower Left of Chart: This is the Last Edition of this chart. It will be canceled on 05-Jul-23.	NOS	--
LAST EDITION	No new editions of chart 13235 will be published. It will be canceled on 05-Jul-23. Comparable or larger scale Electronic Navigational Chart (ENC) coverage is available. See "Cancellation of NOAA Paper and Raster Nautical Charts" in Section I of this LNM for details. A list of all canceled NOAA charts is at https://www.charts.noaa.gov/MCD/Dole.shtml .	NOS	--

13236 33rd Ed. 01-APR-20 Last LNM: 39/19 NAD 83 02/23

ChartTitle: Cape Cod Canal and Approaches

Main Panel 2107 CAPE COD CANAL AND APPROACHES MA --. Page/Side: -

ADD	Lower Left of Chart: This is the Last Edition of this chart. It will be canceled on 05-Jul-23.	NOS	--
LAST EDITION	No new editions of chart 13236 will be published. It will be canceled on 05-Jul-23. Comparable or larger scale Electronic Navigational Chart (ENC) coverage is available. See "Cancellation of NOAA Paper and Raster Nautical Charts" in Section I of this LNM for details. A list of all canceled NOAA charts is at https://www.charts.noaa.gov/MCD/Dole.shtml .	NOS	--

13238 16th Ed. 01-AUG-07 Last LNM: 51/18 NAD 83 02/23

ChartTitle: Martha's Vineyard Eastern Part;Oak Bluffs Harbor;Vineyard Haven Harbor;Edgartown Harbor

Main Panel 2102 MARTHAS VINEYARD - EASTERN PART. Page/Side: N/A

ADD	Lower Left of Chart: This is the Last Edition of this chart. It will be canceled on 05-Jul-23.	NOS	--
LAST EDITION	No new editions of chart 13238 will be published. It will be canceled on 05-Jul-23. Comparable or larger scale Electronic Navigational Chart (ENC) coverage is available. See "Cancellation of NOAA Paper and Raster Nautical Charts" in Section I of this LNM for details. A list of all canceled NOAA charts is at https://www.charts.noaa.gov/MCD/Dole.shtml .	NOS	--

13242 18th Ed. 01-DEC-11 Last LNM: 37/19 NAD 83 02/23

ChartTitle: Nantucket Harbor

Main Panel 2100 NANTUCKET HARBOR MA. Page/Side: N/A

ADD	Lower Left of Chart: This is the Last Edition of this chart. It will be canceled on 05-Jul-23.	NOS	--
LAST EDITION	No new editions of chart 13242 will be published. It will be canceled on 05-Jul-23. Comparable or larger scale Electronic Navigational Chart (ENC) coverage is available. See "Cancellation of NOAA Paper and Raster Nautical Charts" in Section I of this LNM for details. A list of all canceled NOAA charts is at https://www.charts.noaa.gov/MCD/Dole.shtml .	NOS	--

13248 12th Ed. 01-OCT-13 Last LNM: 44/15 NAD 83 02/23

ChartTitle: Chatham Harbor and Pleasant Bay

Main Panel 2097 CHATHAM HARBOR AND PLEASANT BAY MA. Page/Side: N/A

ADD	Lower Left of Chart: This is the Last Edition of this chart. It will be canceled on 05-Jul-23.	NOS	--
LAST EDITION	No new editions of chart 13248 will be published. It will be canceled on 05-Jul-23. Comparable or larger scale Electronic Navigational Chart (ENC) coverage is available. See "Cancellation of NOAA Paper and Raster Nautical Charts" in Section I of this LNM for details. A list of all canceled NOAA charts is at https://www.charts.noaa.gov/MCD/Dole.shtml .	NOS	--

13249 13th Ed. 01-APR-07 Last LNM: 47/18 NAD 83 02/23

ChartTitle: Provincetown Harbor

Main Panel 2096 PROVINCETOWN HARBOR. Page/Side: N/A

ADD	Lower Left of Chart: This is the Last Edition of this chart. It will be canceled on 05-Jul-23.	NOS	--
LAST EDITION	No new editions of chart 13249 will be published. It will be canceled on 05-Jul-23. Comparable or larger scale Electronic Navigational Chart (ENC)	NOS	--

coverage is available. See "Cancellation of NOAA Paper and Raster Nautical Charts" in Section I of this LNM for details. A list of all canceled NOAA charts is at <https://www.charts.noaa.gov/MCD/Dole.shtml>.

13251 **16th Ed.** **01-JUN-11** **Last LNM: 31/19** **NAD 83** **02/23**

ChartTitle: Barnstable Harbor

Main Panel 2093 BARNSTABLE HARBOR MA. Page/Side: N/A

		NOS	
ADD	Lower Left of Chart: This is the Last Edition of this chart. It will be canceled on 05-Jul-23.	--	--
		NOS	
LAST EDITION	No new editions of chart 13251 will be published. It will be canceled on 05-Jul-23. Comparable or larger scale Electronic Navigational Chart (ENC) coverage is available. See "Cancellation of NOAA Paper and Raster Nautical Charts" in Section I of this LNM for details. A list of all canceled NOAA charts is at https://www.charts.noaa.gov/MCD/Dole.shtml .	--	--

13253 **20th Ed.** **01-JUL-10** **Last LNM: 22/20** **NAD 83** **02/23**

ChartTitle: Harbors of Plymouth, Kingston and Duxbury; Green Harbor

Main Panel 2091 HARBORS OF PLYMOUTH KINGSTON AND DUXBURY MA. Page/Side: N/A

		NOS	
ADD	Lower Left of Chart: This is the Last Edition of this chart. It will be canceled on 05-Jul-23.	--	--
		NOS	
LAST EDITION	No new editions of chart 13253 will be published. It will be canceled on 05-Jul-23. Comparable or larger scale Electronic Navigational Chart (ENC) coverage is available. See "Cancellation of NOAA Paper and Raster Nautical Charts" in Section I of this LNM for details. A list of all canceled NOAA charts is at https://www.charts.noaa.gov/MCD/Dole.shtml .	--	--

13269 **11th Ed.** **01-APR-11** **Last LNM: 34/18** **NAD 83** **02/23**

ChartTitle: Cohasset and Scituate Harbors

Main Panel 2087 COHASSET AND SCITUATE HARBORS MA. Page/Side: N/A

		NOS	
ADD	Lower Left of Chart: This is the Last Edition of this chart. It will be canceled on 05-Jul-23.	--	--
		NOS	
LAST EDITION	No new editions of chart 13269 will be published. It will be canceled on 05-Jul-23. Comparable or larger scale Electronic Navigational Chart (ENC) coverage is available. See "Cancellation of NOAA Paper and Raster Nautical Charts" in Section I of this LNM for details. A list of all canceled NOAA charts is at https://www.charts.noaa.gov/MCD/Dole.shtml .	--	--

13270 **66th Ed.** **01-DEC-18** **Last LNM: 02/20** **NAD 83** **02/23**

ChartTitle: Boston Harbor

Main Panel 2086 BOSTON HARBOR MA --. Page/Side: -

		NOS	
ADD	Lower Left of Chart: This is the Last Edition of this chart. It will be canceled on 05-Jul-23.	--	--
		NOS	
LAST EDITION	No new editions of chart 13270 will be published. It will be canceled on 05-Jul-23. Comparable or larger scale Electronic Navigational Chart (ENC) coverage is available. See "Cancellation of NOAA Paper and Raster Nautical Charts" in Section I of this LNM for details. A list of all canceled NOAA charts is at https://www.charts.noaa.gov/MCD/Dole.shtml .	--	--

13275 **32nd Ed.** **01-NOV-13** **Last LNM: 49/20** **NAD 83** **02/23**

ChartTitle: Salem and Lynn Harbors; Manchester Harbor

Main Panel 2072 SALEM AND LYNN HARBORS MA. Page/Side: N/A

		NOS	
ADD	Lower Left of Chart: This is the Last Edition of this chart. It will be canceled on 05-Jul-23.	--	--
		NOS	
LAST EDITION	No new editions of chart 13275 will be published. It will be canceled on 05-Jul-23. Comparable or larger scale Electronic Navigational Chart (ENC) coverage is available. See "Cancellation of NOAA Paper and Raster Nautical Charts" in Section I of this LNM for details. A list of all canceled NOAA charts is at https://www.charts.noaa.gov/MCD/Dole.shtml .	--	--

13279 **34th Ed.** **01-OCT-13** **Last LNM: 49/20** **NAD 83** **02/23**

ChartTitle: Ipswich Bay to Gloucester Harbor; Rockport Harbor

Main Panel 2067 IPSWICH BAY TO GLOUCESTER HARBOR MA. Page/Side: N/A

ADD	Lower Left of Chart: This is the Last Edition of this chart. It will be canceled on 05-Jul-23.	NOS --	--
LAST EDITION	No new editions of chart 13279 will be published. It will be canceled on 05-Jul-23. Comparable or larger scale Electronic Navigational Chart (ENC) coverage is available. See "Cancellation of NOAA Paper and Raster Nautical Charts" in Section I of this LNM for details. A list of all canceled NOAA charts is at https://www.charts.noaa.gov/MCD/Dole.shtml .	NOS --	--

13281 19th Ed. 01-OCT-10 Last LNM: 47/20 NAD 83 02/23

Chart Title: Gloucester Harbor and Annisquam River

Main Panel 2066 GLOUCESTER HARBOR AND ANNISQUAM RIVER . Page/Side: N/A			
ADD	Lower Left of Chart: This is the Last Edition of this chart. It will be canceled on 05-Jul-23.	NOS --	--
LAST EDITION	No new editions of chart 13281 will be published. It will be canceled on 05-Jul-23. Comparable or larger scale Electronic Navigational Chart (ENC) coverage is available. See "Cancellation of NOAA Paper and Raster Nautical Charts" in Section I of this LNM for details. A list of all canceled NOAA charts is at https://www.charts.noaa.gov/MCD/Dole.shtml .	NOS --	--

SECTION V - ADVANCE NOTICES

This section contains advance notice of approved projects, changes to aids to navigation, or upcoming temporary changes such as dredging, etc. Mariners are advised to use caution while transiting these areas.

SUMMARY OF ADVANCED APPROVED PROJECTS

<u>Approved Project(s)</u>	<u>Project Date</u>	<u>Ref. LNM</u>
None		

Advance Notice(s)

NY-SHINNECOCK BAY TO EAST ROCKAWAY INLET (Chart 12352)-JONES INLET

The U.S. Coast Guard will be making the following changes to Jones Inlet with completion of dredging:

The following aids will be REESTABLISHED due to completion of dredging operations:

- Jones Inlet Buoy 6 (LLNR 30890)
- Jones Inlet Buoy 7 (LLNR 30900)
- Jones Inlet Buoy 9 (LLNR 30905)
- Jones Inlet Buoy 11 (LLNR 30910)
- Jones Inlet Buoy 12 (LLNR 30920)
- Jones Inlet Buoy 13 (LLNR 30925)
- Jones Inlet Buoy 14 (LLNR 30927)
- Jones Inlet Buoy 15 (LLNR 30930)
- Jones Inlet Buoy 16 (LLNR 30930)
- Jones Inlet Buoy 17 (LLNR 30930)

The following aids will be RELOCATED back to there original assigned positions due to completion of dredging;

- Jones Inlet Entrance LWB JI (LLNR 30900) to position approximate 40-33-36.507N 073-36-02.920W.
- Jones Inlet LB 1 (LLNR 30905) to position approximate 40-33-58.819N 073-34-56.232W.
- Jones Inlet LB 2 (LLNR 30910) to position approximate 40-33-58.320N 073-34-50.844W.
- Jones Inlet By 3 (LLNR 30920) to position approximate 40-34-22.132N 073-34-54.057W and change hull to unlighted 3NR.
- Jones Inlet LB 4 (LLNR 30925) to position approximate 40-34-21.721N 073-34-47.402W.
- Jones Inlet LB 5 (LLNR 30930) to position approximate 40-34-50.961N 073-34-48.570W and change flash characteristic to Quick Green.
- Jones Inlet LB 6 (LLNR 30935) to position approximate 40-34-51.003N 073-34-43.860W and change flash characteristic to FI 2.5s.

The following aids will be DISESTABLISHED and are no longer required due to completion of dredging;

- Jones Inlet Lighted Buoy 4A (LLNR 30927) from position approximate 40-34-37.996N 073-35-30.860W.
- b. Jones Inlet Buoy 4B (LLNR 30928) from position approximate 40-34-40.704N 073-35-01.938W.
- c. Jones Inlet Hazard Buoy (LLNR 30933) from position approximate 40-34-45.757N 073-34-47.486W.

. Refer to Project No. 01-22-069. E-mail can be sent to:
D01-SMB-DPWPublicComments@uscg.mil .

Chart 12352

LNM: 02/23

ME-DAMARISCOTTA, SHEEPSCOT AND KENNEBEC RIVERS (Chart 13293)-KENNEBEC RIVER-UPPER KENNEBEC RIVER

The U.S. Coast Guard will be making the following changes to Aids to Navigation in this waterway:

CHANGE the seasonal status from permanent (PERM) to Maintained from 15 May - 15 October (SEAN).

(All inclusive) From Upper Kennebec River Buoy 12 (LLNR 6220) to Upper Kennebec River Buoy 47 (LLNR 6340)

Previously advertised as a Proposal in LNM 28/22 Refer to Project No. 01-21-072.

E-mail can be sent to: D01-SMB-DPWPublicComments@uscg.mil.

Charts: 13293 13298

LNM: 28/22

MASSACHUSETTS-NANTUCKET SOUND AND APPROACHES (Chart 13237)-CHATHAM HARBOR APPROACH

Electrical work is being conducted at the U.S. Coast Guard Base in Chatham, Ma from November 9 2022 to January 10, 2023. At times during the work, electrical power may be secured causing disruption to Chatham Light (LLNR 525) and Chatham Inlet Bar Guide Light (LLNR 13305). If the main light at Chatham Light is extinguished, an emergency light of lesser intensity will replace it. Mariners are urged to use caution when navigating in the area.

Charts: 13009 13200 13237 13246 13248

LNM: 45/22

NY-LONG ISLAND SOUND-OYSTER AND HUNTINGTON BAYS (Chart 12365)-HUNTINGTON HARBOR

The U.S. Coast Guard will be making the following change to Aids to Navigation on or about 10 January 2023, weather and operations permitting :

Permanently Disestablish the sound signal for Huntington Harbor Light (LLNR 26530)

Previously advertised as a Proposal in LNM 22/22 Refer to Project No. 01-22-041.

E-mail can be sent to:

D01-SMB-DPWPublicComments@uscg.mil

Charts: 12363 12364 12365

LNM: 22/22

MA-CAPE COD CANAL APPROACHES-CLEVELAND LEDGE CHANNEL

The U.S. Coast Guard is considering making the following changes to Aids to Navigation in this waterway:

Cleveland Ledge Channel Range Rear Light (LLNR 16090) DISESTABLISH

Cleveland Ledge Channel Range Front Light (LLNR 16085) CHANGE to a single point LED lantern with sectors (see links for examples)

1 Lantern Sector Light (<https://marine.sabik.com/oscillating-boundary>)

The Sector Lights give a highly adjustable LED signal that has proven extremely reliable with minimal maintenance and down time.

Previously advertised as a Proposal in LNM 5/21 Refer to Project No. 01-22-045.

E-mail can be sent to:

D01-SMB-DPWPublicComments@uscg.mil

Charts: 13230 13236

LNM: 31/22

MA-NANTUCKET SOUND-NORTH CHANNEL-MAIN CHANNEL-MUSKEGET CHANNEL-UPDATE

The U.S. Coast Guard has temporarily disestablished and removing the following aids to navigation, on or around September 26, 2022 to on or around February 28, 2023, to enable safe cable-laying operations.

Muskeget Channel Buoy 4 (LLN 15370), position 41-22-57.428N 070-25-01.476W.

Muskeget Channel Buoy 6 (LLN 15380), position 41-26-01.303N 070-25-15.749W.

North Channel Wreck Shoal Lighted Buoy 8 (LLN 14780) position 41-32-26.005N 070-24-01.978W.

Mariners are urged to transit at their slowest safe speed and proceed with caution. Public comments or questions about these operations can be forwarded to D01-SMB-LNM@uscg.mil.

LNM: 34/22

ME-CASCO BAY (CHART 13290)-MERRICONEAG SOUND APPROACH

The U.S. Coast Guard will be making the following changes to this waterway:

PERMANENTLY DISESTABLISH Little Mark Island Monument Daybeacon (LLNR 6700).

Previously advertised as a Proposal in LNM 43/21 Refer to Project No. 01-21-020.

E-mail can be sent to:

D01-SMB-DPWPublicComments@uscg.mil .

Charts: 13288 13290

LNM: 43/21

SECTION VI - PROPOSED CHANGES

Periodically, the Coast Guard evaluates its system of aids to navigation to determine whether the conditions for which the aids to navigation were established have changed. When changes occur, the feasibility of improving, relocating, replacing, or discontinuing aids are considered. This section contains notice(s) of non-approved, proposed projects open for comment. SPECIAL NOTE: Mariners are requested to respond in writing to the District office unless otherwise noted (see banner page for address).

PROPOSED WATERWAY PROJECTS OPEN FOR PUBLIC COMMENT

<u>Proposed Project(s)</u>	<u>Closing</u>	<u>Docket No.</u>	<u>Ref. LNM</u>
None			

Proposed Change Notice(s)

MA-SEACOAST- GEORGES BANK AND NANTUCKET SHOALS (Chart 13200)-BOSTON HARBOR APPROACH

The U.S. Coast Guard is considering making the following changes to Aids to Navigation to facilitate navigation in this waterway:

REMOVE the RACON and WHISTLE from Boston Lighted Whistle Buoy B (LLNR 410/10676) and ADD an AIS signal to the aid.

Interested Mariners are strongly encouraged to comment on this proposal in writing, either personally or through their organization. All comments will be carefully considered and are requested prior to 22 February 2023 to complete the process. To most effectively consider your feedback and improve data collection when responding to this proposal, please include size and type of vessel, recreational or commercial, and distance from aid that you start looking for it, and if and how you use the signal. Please do not call the Coast Guard via telephone or other means, only written responses to this proposal will be accepted. Refer to Project No. 01-23-003. E-mail can be sent to: D01-SMB-DPWPUBLICCOMMENTS@USCG.MIL

Charts: 13003 13006 13009 13200 13260 13267 13270 13275 LNM: 01/23

ME-SEACOAST- BAY OF FUNDY TO CAPE COD (Chart 13260)-PORTLAND HARBOR APPROACH

The U.S. Coast Guard is considering making the following changes to Aids to Navigation to facilitate navigation in this waterway:

REMOVE the RACON and WHISTLE from Portland Lighted Whistle Buoy P (LLNR 45/7480) and ADD an AIS signal to the aid.

Interested Mariners are strongly encouraged to comment on this proposal in writing, either personally or through their organization. All comments will be carefully considered and are requested prior to 22 February 2023 to complete the process. To most effectively consider your feedback and improve data collection when responding to this proposal, please include size and type of vessel, recreational or commercial, and distance from aid that you start looking for it, and if and how you use the signal. Please do not call the Coast Guard via telephone or other means, only written responses to this proposal will be accepted. Refer to Project No. 01-23-002. E-mail can be sent to: D01-SMB-DPWPUBLICCOMMENTS@USCG.MIL

Charts: 13003 13006 13009 13286 13288 LNM: 01/23

NY AND NJ-NEW YORK HARBOR (Chart 12327)-SANDY HOOK CHANNEL

The U.S. Coast Guard is considering making the following changes to Aids to Navigation to facilitate navigation in this waterway:

REMOVE the RACON and WHISTLE from Scotland Lighted Whistle Buoy S (LLNR 35085) and ADD an AIS signal to the aid.

Interested Mariners are strongly encouraged to comment on this proposal in writing, either personally or through their organization. All comments will be carefully considered and are requested prior to 22 February 2023 to complete the process. To most effectively consider your feedback and improve data collection when responding to this proposal, please include size and type of vessel, recreational or commercial, and distance from aid that you start looking for it, and if and how you use the signal. Please do not call the Coast Guard via telephone or other means, only written responses to this proposal will be accepted. Refer to Project No. 01-23-007. E-mail can be sent to: D01-SMB-DPWPUBLICCOMMENTS@USCG.MIL

Charts: 12300 12324 12326 LNM: 01/23

NY-BLOCK ISLAND SOUND AND GARDINERS BAY (Chart 13209)

The U.S. Coast Guard is considering making the following changes to Aids to Navigation to facilitate navigation in this waterway:

REMOVE the RACON and WHISTLE from Valiant Rock Lighted Whistle Buoy 11 (LLNR 19825) and ADD an AIS signal to the aid.

Interested Mariners are strongly encouraged to comment on this proposal in writing, either personally or through their organization. All comments will be carefully considered and are requested prior to 22 February 2023 to complete the process. To most effectively consider your feedback and improve data collection when responding to this proposal, please include size and type of vessel, recreational or commercial, and distance from aid that you start looking for it, and if and how you use the signal. Please do not call the Coast Guard via telephone or other means, only written responses to this proposal will be accepted. Refer to Project No. 01-23-005. E-mail can be sent to: D01-SMB-DPWPUBLICCOMMENTS@USCG.MIL

Charts: 12300 12354 12372 13205 13209 13212 LNM: 01/23

NY-NEW YORK HARBOR (Chart 12327)-AMBROSE CHANNEL

The U.S. Coast Guard is considering making the following changes to Aids to Navigation to facilitate navigation in this waterway:

REMOVE the RACON and WHISTLE from Ambrose Channel Lighted Whistle Buoy A (LLNR 34785) and ADD an AIS signal to the aid.

Interested Mariners are strongly encouraged to comment on this proposal in writing, either personally or through their organization. All

comments will be carefully considered and are requested prior to 22 February 2023 to complete the process. To most effectively consider your feedback and improve data collection when responding to this proposal, please include size and type of vessel, recreational or commercial, and distance from aid that you start looking for it, and if and how you use the signal. Please do not call the Coast Guard via telephone or other means, only written responses to this proposal will be accepted. Refer to Project No. 01-23-006. E-mail can be sent to: D01-SMB-DPWPUBLICComments@uscg.mil.

Charts: 12300 12326 13006

LNLM: 01/23

RI-SEACOAST-NARRAGANSETT BAY (Chart 13221)-EASTERN APPROACH

The U.S. Coast Guard is considering making the following changes to Aids to Navigation to facilitate navigation in this waterway:

REMOVE the RACON and WHISTLE from Narragansett Bay Entrance Lighted Whistle Buoy NB (LLNR 17675) and ADD an AIS signal to the aid.

Interested Mariners are strongly encouraged to comment on this proposal in writing, either personally or through their organization. All comments will be carefully considered and are requested prior to 22 February 2023 to complete the process. To most effectively consider your feedback and improve data collection when responding to this proposal, please include size and type of vessel, recreational or commercial, and distance from aid that you start looking for it, and if and how you use the signal. Please do not call the Coast Guard via telephone or other means, only written responses to this proposal will be accepted. Refer to Project No. 01-23-004. E-mail can be sent to: D01-SMB-DPWPUBLICComments@uscg.mil.

Charts: 12300 13218 13221

LNLM: 01/23

CONNECTICUT- LONG ISLAND SOUND- NEW LONDON HARBOR AND VICINITY (Chart 13213)-NEW LONDON HARBOR

The U.S. Coast Guard is considering making the following change to Aids to Navigation:

DISESTABLISH the following aid;

New London Harbor Channel Buoy 8 (LLNR 21880)

This change is due to changes to the waterfront in this area.

Interested Mariners are strongly encouraged to comment on this proposal in writing, either personally or through their organization. All comments will be carefully considered and are requested prior to 18 January 2023 to complete the process. In order to most effectively consider your feedback and improve or data collection when responding to this proposal, please include size and type of vessel, recreational or commercial, and distance from aid that you start looking for it, and if and how you use the signal. Please do not call the Coast Guard via telephone or other means, only written responses to this proposal will be accepted. Refer to Project No. 01-22-073. E-mail can be sent to: D01-SMB-DPWPUBLICComments@uscg.mil.

Charts: 12372 13212 13213

LNLM: 48/22

ME-FRENCHMAN AND BLUE HILL BAYS AND APPROACHES-FRENCHMAN BAY-Revised

The U.S. Coast Guard is considering making the following changes to Aids to Navigation to facilitate navigation in this waterway:

DISESTABLISH Frenchman Bay Lighted Buoy FB (LLNR 1860) and ADD an AIS virtual signal to the assigned position.

Interested Mariners are strongly encouraged to comment on this proposal in writing, either personally or through their organization. All comments will be carefully considered and are requested prior to 4 January 2023 to complete the process. In order to most effectively consider your feedback and improve data collection when responding to this proposal, please include size and type of vessel, recreational or commercial, and distance from aid that you start looking for it, and if and how you use the signal. Please do not call the Coast Guard via telephone or other means, only written responses to this proposal will be accepted. Refer to Project No. 01-22-063. E-mail can be sent to: D01-SMB-DPWPUBLICComments@uscg.mil.

Charts: 13006 13260 13312

LNLM: 35/22

SECTION VII - GENERAL

This section contains information of general concern to the Mariners. Mariners are advised to use caution while transiting these areas.

Outreach/Educational Efforts to Protect the North Atlantic Right Whale

Northeast- D1 (01JAN-31JUL): QUOTE. US- AtlanticSeacoast - Critically endangered right whales may be encountered in offshore and coastal waters. Right whales are slow moving and at risk of serious injury or death due to collisions with vessels. Collisions with whales are dangerous - passengers can be injured and vessels badly damaged. U.S. law (50 CFR 224.105) prohibits operating vessels 65 feet (19.8 m) or greater in excess of 10 knots in specific managed locations along the U.S. East Coast during times when right whales are likely to be present. See enclosed compliance guide for specific times, areas, and exceptions to this law. Approaching or remaining within 500 yards of right whales is prohibited and is a violation of U.S. law. A minimum distance of 500 yards must be maintained from a sighted whale unless hazardous to the vessel or its occupants. The National Oceanic and Atmospheric Administration (NOAA) recommends that operators assume that any whale sighted is a right whale unless confirmed otherwise. NOAA also recommends speeds of 10 knots or less in areas used by right whales and outside of seasonally managed areas when consistent with safety of navigation. In the northeast, please report all right whale sightings, collisions, or entanglements to 866-755-NOAA, or to the Coast Guard via channel 16. WHALESNORTH Mandatory Ship Reporting Area is active year-round. For more information, consult the U.S. Coast Pilot. MSR arrival reports can be sent to rightwhale.msr(at)noaa.gov.

Outreach/Educational Efforts to Protect the North Atlantic Right Whale

NOAA Right Whale Slow Zones Campaign NOAA Fisheries uses the "Right Whale Slow Zones" campaign to reduce the risk of vessel strike to critically endangered North Atlantic right whales. Complementary to other NOAA vessel strike reduction efforts, the Slow Zones campaign brings together sighting information from NOAA's Dynamic Management Area program with acoustic detection information from underwater receivers to establish voluntary speed reduction areas. Read more about the new campaign in the web story (link follows). Media Questions: Contact Allison Ferreira, Regional Office, 978-281-9103 Inquiries about the right whale Slow Zone program: Alicia Schuler, Protected Resources Division (978) 281-9235 Further

Slow Zone details:

<https://www.fisheries.noaa.gov/NATIONAL/ENDANGERED-SPECIES-CONSERVATION/REDUCING-VESSEL-STRIKES-NORTH-ATLANTIC-RIGHT-WHALES>

LNM: 48/22

MAINE GENERAL NOTICES

Information for Mariners using the Waterways of the State of Maine.

VERMONT GENERAL NOTICES

Information for Mariners using the Waterways of Lake Champlain in the State of Vermont.

NEW HAMPSHIRE GENERAL NOTICES

Information for Mariners using the Waterways of the State of New Hampshire. Newest on top.

NH- PISCATAQUA RIVER-NEWINGTON

CDM Constructors Inc. will be dismantling a former fuel pier, on the Piscataqua River, in Newington, NH, in position 43-6-27.16N, 070-47-52.85W, from July 19, 2022 through May 2024. Equipment on scene will be sporadic depending on phase of project. Two working barges will be mobilized for crews and heavy equipment (excavator and Lull). Miscellaneous support vessels may also be present, monitoring VHF/CH-13 and 16. Work barges will be centralized to work areas only and will not impede navigation. Mariners are urged to transit at their slowest safe speed to minimize wake and protect the environment.

LNM: 29/22

MASSACHUSETTS GENERAL NOTICES

Information for Mariners using the Waterways of the State of Massachusetts. Newest on top.

MA-LYNN-ROCKPORT

Edge Cable Holdings USA, LLC, is announcing the start of in-water work related to cable installation for the Amitié Fiber Optic Cable Project. This work will include pre-lay clearance activities and offshore cable installation in Massachusetts State Waters from Lynn to Rockport and nearshore activities exclusively in Lynn. Nearshore activities are anticipated to commence February 1, 2023, and occur until February 28, 2023, in position 42-41-6.9N, 070-00.0W. Pre-lay clearance activities are anticipated to commence February 1, 2023 and occur over a 2-day time period within state waters. Offshore cable installation is anticipated to commence February 3, 2023 and occur over a 4-day time period within state waters. Pre-lay clearance and offshore installation activities will start in Lynn and end in Rockport during these timeframes. Post-lay jet burial is targeted to occur within the municipalities of Lynn and Manchester-by-the-Sea between February 23, 2023, and February 28, 2023. The provided dates are subject to change based on suitable installation conditions. Equipment on scene throughout the project will be the Atlantic Merlin, Cable ship DECISIVE, M/V Ile De Molene, FV Karoline Marie, and FV Becky Lynne and will be monitoring VHF-FM CH 16 for any concerned traffic. Additional information about Project activities, contact information, and schedule updates can be accessed by visiting the following website:

<https://amitie-submarine-cable-erm.hub.arcgis.com/> Mariners are advised to use caution and transit at slow speed to minimize wake when transiting the area.

LNM: 02/23

NY- SOUTH OF NANTUCKET

NOAA fisheries announces that a voluntary vessel speed restriction zone under the Right Whale Slow Zone Program is currently in effect south of Nantucket to protect right whales. This right whale slow zone is in effect through January 23, 2023. NOAA requests mariners to route around this zone or transit through it at ten knots or less. The south of Nantucket slow zone is bounded by:

41 degrees 25 minutes north, 40 degrees 24 minutes north,

069 degrees 44 minutes west, 070 degrees 44 minutes west.

Information about voluntary vessel speed restrictions can also be found at:

[HTTPS://WWW.FISHERIES.NOAA.GOV/NATIONAL/ENDANGERED-SPECIES-CONSERVATION/REDUCING-VESSEL-STRIKES-NORTH-ATLANTIC-RIGHT-WHALES](https://www.fisheries.noaa.gov/NATIONAL/ENDANGERED-SPECIES-CONSERVATION/REDUCING-VESSEL-STRIKES-NORTH-ATLANTIC-RIGHT-WHALES)

LNM: 02/23

MA-CAPE COD BAY-DENNIS-SESUIT HARBOR

Barnstable County Dredging will be conducting dredging operations in the Sesuit Harbor, Dennis, MA, in position 41-45.21N 070-09.15W, from January 16 to 31, 2023. Dredging will run Monday through Saturday between 7:00am to 4:00pm. Equipment on scene will be the Cod Fish II, Pushboat – Bradbury and several support boats and approximately 1,500 feet of pipeline. The dredge boat Cod Fish II is stationary and has limited maneuverability. The discharge pipe will be floating at times during dredging operations and may be blocking the channel. Mariners are requested to give adequate clearance to the equipment at all times and maintain communications as needed, through VHF-FM CH 16, and 18. Mariners are advised to use caution and transit at slow speed to minimize wake when transiting the area.

Chart 13246

LNM: 02/23

MA- SOUTHWEST OF NANTUCKET

NOAA fisheries announces that a voluntary vessel speed restriction zone under the Right Whale Slow Zone Program is currently in effect southwest of Nantucket to protect right whales. This right whale slow zone is in effect through January 16, 2023. NOAA requests mariners to route around this zone or transit through it at ten knots or less. The southwest of Nantucket slow zone is bounded by:

41 degrees 25 minutes north, 40 degrees 45 minutes north,
069 degrees 59 minutes west, 070 degrees 52 minutes west.

Information about voluntary vessel speed restrictions can also be found at:

[HTTPS://WWW.FISHERIES.NOAA.GOV/NATIONAL/ENDANGERED-SPECIES-CONSERVATION/REDUCING-VESSEL-STRIKES-NORTH-ATLANTIC-RIGHT-WHALES](https://www.fisheries.noaa.gov/national/endangered-species-conservation/reducing-vessel-strikes-north-atlantic-right-whales)

LNM: 01/23

MA-CAPE COD BAY

NOAA fisheries announces that a voluntary vessel speed restriction zone under the Right Whale Slow Zone Program is currently in effect in Cape Cod Bay to protect right whales. This right whale slow zone is in effect through January 5, 2023. NOAA requests mariners to route around this zone or transit through it at ten knots or less. The Cape Cod Bay slow zone is bounded by:

42 degrees 09 minutes north, 41 degrees 31 minutes north,
069 degrees 56 minutes west, 070 degrees 47 minutes west.

Information about voluntary vessel speed restrictions can also be found at:

[HTTPS://WWW.FISHERIES.NOAA.GOV/NATIONAL/ENDANGERED-SPECIES-CONSERVATION/REDUCING-VESSEL-STRIKES-NORTH-ATLANTIC-RIGHT-WHALES](https://www.fisheries.noaa.gov/national/endangered-species-conservation/reducing-vessel-strikes-north-atlantic-right-whales)

LNM: 52/22

MA- BUZZARDS BAY – FALMOUTH- NYES NECK - DATA BUOY-Update

The Woods Hole Group has installed a Water Quality Monitoring Data Buoy in the vicinity of Nyes Neck, North Falmouth, MA, in approximate position of 41-38-9.72N / 070-39-16.62W, on July 14, 2022. The buoy is a CB-450 Data Buoy, with a flashing 3.5 sec amber light (FL Y 3.5S) at a range of 1-2nm. For questions contact Mr. David Walsh at dwalsh@woodsholegroup.com or (508)495-6254



Chart 13229

LNM: 26/22

RHODE ISLAND GENERAL NOTICES

Information for Mariners using the Waterways of the State of Rhode Island. Newest on top.

RI-NARRAGANSETT BAY–MT HOPE BAY–Vessel Testing-Update 10/24/2022

Regent Craft Inc. will be testing a prototype wing-in-ground-effect (WIG) craft in Narragansett Bay and Mt Hope Bay beginning July 7, 2022 until approximately May 31, 2023. The testing areas include the waters of Narragansett Bay, east and west of Prudence Island, and Mt Hope Bay. Testing of the prototype will last approximately 2-4 hours, Monday through Friday with occasional tests on weekends and occur during daylight hours only. All mariners are advised to use caution when transiting through these areas and avoid these areas if possible while testing is ongoing to deconflict traffic conditions. The vessel can be reached on VHF channel 13/16. For further information, please contact U.S. Coast Guard Sector Southeast New England at (508) 457-3211.

Chart 13226

LNM: 27/22

RI-DYER ISLAND

There is a partially submerged vessel in position 41-34-54.78N and 071-18-6.48W, in the vicinity of Dyer Island being marked by a white danger buoy. Mariners are urged to transit at their slowest safe speed, avoid the vessel, and proceed with caution.



Chart 13221 13223

LNM: 30/22

CONNECTICUT GENERAL NOTICES

Information for Mariners using the Waterways of the State of Connecticut. Newest on top.

CT-THAMES RIVER-GROTON

General Dynamics Electric Boat will be conducting sensitive exterior repair on vessel near the waterline at General Dynamics Electric Boat Graving Docks on the Thames River in Groton, CT, in position 41-20-36.772N 072-4-56.838W. Work will commence on January 16 to 30, 2023, 24 hours a day seven days a week. Equipment on scene will be a vacuum pump pierside with associated lines running to the vessel. Mariners are advised to use caution and transit at slow speed to minimize wake when transiting the area.

Chart 13213

LNM: 02/23

CT-STAMFORD HARBOR

SoundWaters, Inc. will be installing and grow lines for sugar kelp harvesting in position 41-0-30.05N 073-3313.37W and 41-0-23.12N, 073-13-10.4W, from November 7, 2022 to June 15, 2023, 24 hours a day seven days a week. The area will be marked with eight white and orange regulatory buoys. Mariners are advised to use caution and transit at slow speed to minimize wake when transiting the area.

Chart 12368

LNM: 44/22

NEW YORK GENERAL NOTICES

Information for Mariners using the Waterways of the State of New York including Lake Champlain, NY side. Newest on top.

NY- SOUTHEAST OF NEW YORK CITY

NOAA fisheries announces that a voluntary vessel speed restriction zone under the Right Whale Slow Zone Program is currently in effect southeast of New York City to protect right whales. This right whale slow zone is in effect through January 21, 2023. NOAA requests mariners to route around this zone or transit through it at ten knots or less. The southeast of New York City slow zone is bounded by:

40 degrees 35 minutes north, 39 degrees 56 minutes north,
072 degrees 47 minutes west, 070 degrees 40 minutes west.

Information about voluntary vessel speed restrictions can also be found at:

[HTTPS://WWW.FISHERIES.NOAA.GOV/NATIONAL/ENDANGERED-SPECIES-CONSERVATION/REDUCING-VESSEL-STRIKES-NORTH-ATLANTIC-RIGHT-WHALES](https://www.fisheries.noaa.gov/national/endangered-species-conservation/reducing-vessel-strikes-north-atlantic-right-whales).

LNM: 02/23

NY- SOUTHEAST OF NEW YORK CITY

NOAA fisheries announces that a voluntary vessel speed restriction zone under the Right Whale Slow Zone Program is currently in effect southeast of New York City to protect right whales. This right whale slow zone is in effect through January 12, 2023. NOAA requests mariners to route around this zone or transit through it at ten knots or less. The southeast of New York City slow zone is bounded by:

40 degrees 35 minutes north, 39 degrees 56 minutes north,
072 degrees 47 minutes west, 073 degrees 40 minutes west.

Information about voluntary vessel speed restrictions can also be found at:

[HTTPS://WWW.FISHERIES.NOAA.GOV/NATIONAL/ENDANGERED-SPECIES-CONSERVATION/REDUCING-VESSEL-STRIKES-NORTH-ATLANTIC-RIGHT-WHALES](https://www.fisheries.noaa.gov/national/endangered-species-conservation/reducing-vessel-strikes-north-atlantic-right-whales)

LNM: 01/23

NY-CITY ISLAND- ORCHARD BEACH

Multiple reports have identified a partially submerged wreck/obstruction north of City Island, NY at the southernmost point of Orchard Beach, in position 40-51-38N, 073-47-27W. The wreck is only visible at low tide. Mariners are advised to use caution and transit at slow speed to minimize wake when transiting the area.

Chart 12366 12364 12363

LNM: 43/22

NY-UPPER BAY-MANHATTAN (REVISED)

A sheet pile has partially detached from the western face of the concrete pier located at the Coast Guard building at Battery Park in Manhattan. The pier is marked with a dayboard marked DANGER DO NOT MOOR. All mariners are advised to transit the area with caution.

LNM: 51/19

NEW JERSEY GENERAL NOTICES

Information for Mariners using the Waterways of the State of New Jersey (Shrewsbury/Navisink Rivers North). Newest on top.

NJ-NEWARK BAY

Maher Terminals will be conducting steel pile pipe installation in position 40-40-07.732N, 074-08-32.778N, from January 23 to February 23, 2023, Monday through Friday. Equipment on scene will remain on landside of the existing fender line and will have no impediment to vessel navigation. Mariners are advised to use caution and transit at slow speed to minimize wake when transiting the area.

LNM: 02/23

SECTION VIII - LIGHT LIST CORRECTIONS

An Asterisk *, indicates the column in which a correction has been made to new information

(1) No.	(2) Name and Location	(3) Position	(4) Characteristic	(5) Height	(6) Range	(7) Structure	(8) Remarks
None							

PUBLICATION CORRECTIONS

None

ENCLOSURES

EXISTING SHOALING

Summary of areas experiencing shoaling that still exists and has been previously advertised.

DREDGING AND MARINE CONSTRUCTION

Summary of ongoing Dredging and Marine Construction projects

OFFSHORE RENEWABLE ENERGY INSTALLATION (OREI) WORK

Summary of ongoing work for OREI.

BRIDGES

Ongoing Bridge projects throughout the District

MARINE EVENTS

No Marine Events happening this week.

UNEXPLODED ORDANCES (UXO)

Summary of Unexploded Ordnances found during survey operations.

WHALE SLOW ZONES

Summary of Northern Right Whale sightings throughout the District.

John W. Mauger
Rear Admiral, U.S. Coast Guard
Commander, First Coast Guard District

SUMMARY OF SHOALING REPORTED FIRST COAST GUARD DISTRICT

Updated 1/11/2023

NEW OR UPDATED INFORMATION

New, updated or very important information in this enclosure will be highlighted in yellow.

MAINE SHOALING

ME-SACO BAY AND VICINITY (Chart 13287) –RICHMOND ISLAND HARBOR–SCARBOROUGH RIVER

There is serious shoaling in the entrance to the Scarborough River in the vicinity of gated Buoys 1-2 and 3-4. Soundings of +0.8 at Mean Lower Low Water (MLLW) has been surveyed, that means the bottom is exposed at the lowest possible tide. Mariners are advised to use caution when transiting the Scarborough River and do so only at higher tides.

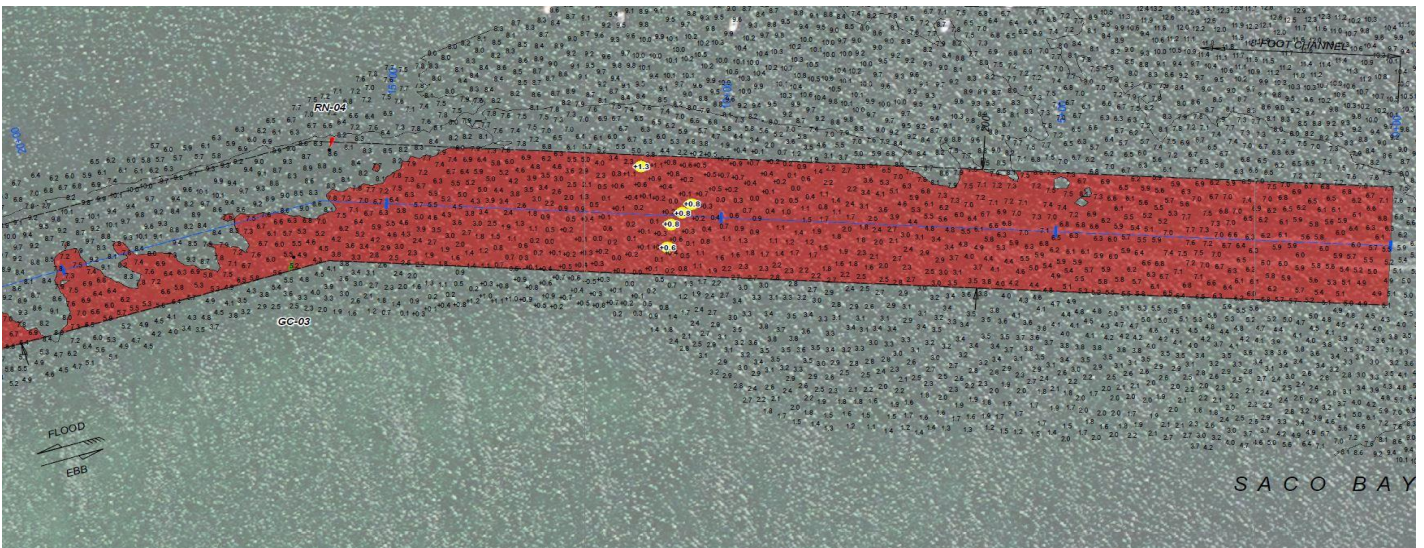

13286 13287 LNM 42/21

ME-THOMASTON-SAINTE GEORGE RIVER-Shoaling

The St. George River in the vicinity of Thomaston Harbor has experienced heavy shoaling. Shoaling in spots has reduced the channel depth to less than 2 ft. at MLLW. Mariners are advised to use caution when transiting St. George River north of nun buoy #16 to Brooklyn Heights Bridge. For further information please contact Clayton Franklin, 207-767-0393.

13301 LNM 28/21

NEW HAMPSHIRE SHOALING

NONE REPORTED

MASSACHUSETTS SHOALING

MA-CAPE COD CANAL-CAPE COD CANAL DEEP DRAFT UPDATE

The maximum deep draft for transiting the Cape Cod Canal has been restored to 32 feet, effective September 21, 2022. Due to sand shoaling in two locations, vessels drawing greater than 25 feet should consult well in advance with the Marine Traffic Controller on duty at 978-318-8500. One sand shoal at 30 feet MLLW is located at station 05, east entrance of the Canal in the vicinity of GC "7" and one at 29 feet MLLW is located at station 155, ¼ mile west of the Sagamore Bridge. Mariners are advised to continue to monitor the Local Notice to Mariners for updates.

LNM: 38/22 Chart 12326

MA-WESTPORT CHANNEL

Westport Channel has experienced increase shoaling, with considerable narrowing of the channel. Mariners are advised that shoaling has been identified and extends the entire width of the channel, affecting both commercial and recreational vessels. Mariners should proceed with caution while transiting the area.

Chart 13228 LNM 30/22

MA-ESSEX BAY

Essex Bay entrance has experienced increased shoaling from Essex Bay Buoy 3 in approximate position 42-40.4N 070-42.7W to Essex Bay Buoy 3A in approximate position 42-40.3N 070-43.3W. Mariners are advised that shoaling has been identified and extends the entire width of the channel to a least depth of 2 feet mean low water (MLW). Mariners without local knowledge are advised to transit with extreme caution and only during plus tides.

Essex Bay Channel Buoy 16 has been reported having increased shoaling. Mariners are urged to use caution while transiting the area.

Chart 13274 LNM 24/22

MA-MERRIMACK RIVER ENTRANCE

Severe shoaling has been reported in the entrance to the Merrimack River. Mariners should proceed with caution while transiting the area.

Chart 13278 LNM 02/14

MA-MERRIMACK RIVER-JOPPA FLAT AREA

Severe shoaling has been reported between Merrimack River Lighted Buoy 13 (LLNR 9050) - North Pier Light 18 (LLNR 9070). The channel shoals to 6 feet versus 9 feet. Mariners should proceed with caution while transiting the area.

Chart 13278 LNM 02/14

Encl 1

MA-NEWBURYPORT HARBOR AND PLUM ISLAND SOUND-SHOALING

Shoaling exists in Plum Island Sound between Plum Island Sound Entrance buoy 4 (LLNR 9310) and Plum Island Sound Entrance buoy 6 (LLNR 9320), aids are not properly marking best water. Mariners are advised to use caution while navigating this area. All of Plum Island is particularly susceptible to shoaling, the area between 4 and 6 being the worst at the mouth of the channel. Last year the unit partnered with the harbor Master moving the aids to mark the best water. Even though the aids are in the best possible locations that water is still shallow at low tide and mariners should use caution while navigating in this area.

Newburyport Harbor and Plum Island Sound – Plum Island Sound Entrance has experienced an increase in shoaling between Plum Island Sound Entrance Buoy 6 and 8. The shoaling was observed in approx. position 42-41.365N /070-45.169W and extends 100 yards west following the channel. Mariners are advised that at MLLW depths of 3' could be seen. Mariners without local knowledge are advised to transit with extreme caution and monitor tidal stations prior to transiting.

Chart 13274 13279 13282 LNM 25/22

MA-ANNISQUAM RIVER

Severe shoaling has been reported in the Annisquam River. Annisquam River channel buoy 24 (LLNR 9690) has been relocated due to recent shoaling in the area to mark best water. Mariners should proceed with caution while transiting the area.

Chart 13274 LNM 24/22

MA-LYNN HARBOR

Increased shoaling has been reported between Sandy Point Light 11 (LLNR 10595) - Lynn Harbor Channel Lighted Buoy 14 (10610). Mariners should proceed with caution while transiting the area.

Chart 13274 LNM 02/14

MA-SALEM AND LYNN HARBORS (Chart 13275)-SAUGUS RIVER APPROACH CHANNEL

Severe shoaling has been reported in the Saugus River in the vicinity of Saugus River Approach Channel Lighted Buoy 5 (LLNR 10655). Mariners should proceed with caution while transiting the area.

Chart 13274 13275 LNM 15/21

MA-SALEM AND LYNN HARBORS (CHART 13275)-BASS RIVER

Severe shoaling has been reported between Bass River Channel Buoy 2 (LLNR 10325)-Bass River Channel Buoy 9 (LLNR 10355) and there is a severe decrease in the channel's width. Mariners should proceed with caution while transiting the area.

Chart 13275 LNM 02/14

MA-MARSHFIELD-NEW INLET

Shoaling has been reported from the North River junction buoy towards the #2 buoy South River. This area is reported as approx. 3.0 feet during the low tide. Mariners should use caution while transiting the area, especially during astronomical low tides.

Chart 13267 LNM 15/16

Encl 1

MA-NUMMET CHANNEL (REVISED)

The Coast Guard has received a report of shoaling in the vicinity of The Nummet Channel Buoy 7 (LLNR 12760). Mariners are advised to proceed with caution when transiting the area.

Chart 13253 LNM 38/10

MA – BARNSTABLE HARBOR – SHOALING

Mariners be advised that shoaling exists in the Barnstable Harbor Entrance channel. Shoaling extends approximately 200 feet into the channel north of Barnstable Harbor Entrance Lighted Buoy 6, in the vicinity of position 41-.43.5 N, 070-16.3W. Water depth is estimated to be 2 feet at low tide in this area. All mariners are requested to use caution while transiting the area.

Chart 13238 LNM 40/18

MA-NANTUCKET SOUND AND APPROACHES (Chart 13237)-POLLOCK RIP CHANNEL

The entrance to Pollock Rip Channel from the East continues to have SEVERE shoaling East of Pollock Rip Lighted Buoy 4 (LLNR 13535). Mariners should not attempt to transit the area without local knowledge of the shoals and use the channel at their own risk. If transiting the channel, Mariners are urged to transit at their slowest safe speed and proceed with extreme caution.

Chart 13237, 13244 LNM 41/21

MA-MARTHA'S VINEYARD TO BLOCK ISLAND (Chart 13218)-WESTPORT HARBOR

Shoaling exists in Westport Harbor in the vicinity of Westport Harbor Channel LB 14 (LLNR 17490) and Westport Harbor Channel Buoy 17 (LLNR 17505). There are other areas of shoaling throughout the Westport Harbor Channel reducing the available depth of water. Mariners are advised to use caution while navigating this area.

Chart 13228 LNM 31/20

MA – CUTTYHUNK HARBOR – ENTRY CHANNEL

Mariners are advised that the navigable width of the entry channel into Cuttyhunk Harbor has decreased to approximately 15 feet wide. This may cause navigability issues and restrict movement for two way traffic. Mariners are urged to maintain a proper lookout and use extreme caution while transiting the area. You may contact the local harbormaster by phone at (508) 990-7578.

Chart 13230 LNM 29/19

RHODE ISLAND SHOALING

RI-NARRAGANSETT BAY (CHART 13221)-GREENWICH BAY-WARWICK COVE

Shoaling has been observed within the federal navigation channel to a least depth of 3 FT MLW. Shoaling is encroaching from the west and has impacted the western part of the channel, reducing the authorized project width from 150 feet to approx. 90 feet between Warwick Cove Buoy 3 (LLNR 19360) and Warwick Cove Buoy 7 (LLNR 19375).

Chart 13224 LNM 02/22

RI-BLOCK ISLAND SOUND AND APPROACHES (CHART 13205)-POINT JUDITH POND

Shoaling has been observed within the channel to a least depth of 5.5 feet MLW in approximate position 41 22'48"N, 071 33'55"W between Point Judith Pond Channel Buoy 2 (LLNR 19555) and Point Judith Pond Channel Buoy 4 (LLNR #19560). Shoal is encroaching from the East side of the channel and protruding west.

Chart 13219 LNM 02/22

Encl 1

RI-NARRAGANSETT BAT (CHART 13221)-MOUNT HOPE BAY-KICKAMUIT RIVER

Shoaling has been reported in the Kickamuit River in the vicinity of Kickamuit River Buoy 2. Mariners are advised to proceed with caution while transiting the area.

Chart 13221 LNM 12/21

NEW YORK SHOALING

NY-GREAT KILLS HARBOR

Shoaling has been reported in in the vicinity of Great Kills Harbor, between buoys 6 and 8. Mariners are advised to proceed with caution while transiting the area.

Chart 12327 LNM 49/22

NY-BLOCK ISLAND SOUND AND GARDINERS BAY-GARDINERS BAY SOUTH ENTRANCE-ACABONACK HARBOR

Mariners are advised that dangerous shoaling conditions exist in Acabonack Harbor and vicinity which cause dangerous conditions when transiting the channel. Acabonack Harbor Buoys 1-4 (Private aids have been temporarily discontinued until the harbor is dredged. Mariners should exercise extreme caution when navigating the channel.

Chart 13209 LNM 30/22

NY-SAYVILLE-BROWNS CREEK

Mariners be advised, dangerous shoaling conditions exist east of Browns Creek and vicinity which cause dangerous conditions when transiting the channel. Mariners should exercise extreme caution when navigating the channel.

Chart 12352 LNM30/22

NY-SHEEPSHEAD BAY TO NEW YORK

Increased shoaling found in the vicinity of Sheepshead Bay Channel, specifically near Sheepshead Bay Buoys 6 and 7. Aids marking the channel may be unreliable. All mariners are urged to use extreme caution when transiting this area.

Chart 12350 LNM 29/22

NY-SHINNECOCK BAY TO EAST ROCKAWAY INLET-FIRE ISLAND INLET

East Rockaway Inlet is experiencing severe shoaling in the inlet west of the breakwater and in between Lighted Buoys 5 and 6. Mariners are urged to use extreme caution while navigating Inlet. The Coast Guard will remark best water until dredging of the Inlet can be completed.

Chart 12352 LNM 23/22

NY-RAUNT CHANNEL (Booklet Chart 12350 JAMAICA BAY

Recent surveys has shown significant shoaling in the Raunt Channel. Shoaling exists in the vicinity of Buoy 6, in approximate position 40-36.17N 073-50.47W. Depths of less than 5 feet in the middle of the channel. Navigation of the area requires extreme caution due to the encroaching nature of the shoal.

Chart 12350 LNM 12/22

Encl 1

NY-SHINNECOCK BAY TO EAST ROCKAWAY INLET-JONES INLET

Mariners be advised, dangerous shoaling conditions exist east of Jones Inlet and vicinity which cause dangerous conditions when transiting the channel. Mariners should exercise extreme caution when navigating the channel.

Chart 12352 LNM 32/21

NY-LONG ISLAND SOUND (Eastern Part) (Chart 12354)-SOUTH SIDE-MATTITUCK INLET

Shoaling has been reported in the Mattituck Inlet. Mariners are advised to proceed with caution while transiting the area.

Chart 12358 LNM 12/21

NY-SHINNECOCK BAY TO EAST ROCKAWAY INLET (Chart 12352)-MORICHES BAY

Severe shoaling is present in Moriches Bay along the Long Island Intracoastal Waterway in the vicinity of Moriches Bay Buoys 21, 24, 26, 27, 28, and 29 extending the entire width of the channel at nearly all tide levels. The area from Buoys 24 to 29 is only navigable at the operator's risk. The most severe area of shoaling can be found between buoys 26 and 28 and is less than half the charted channel depth in some areas. Mariners should be aware that the Aids to Navigation in these areas are unreliable due to shoaling and mariners are strongly advised to seek alternate routes.

Chart 12352 LNM 16/20

NY-SHINNECOCK BAY TO EAST ROCKAWAY INLET

Mariners be advised, dangerous shoaling conditions exist in the East Rockaway Inlet and vicinity. Mariners should exercise extreme caution when navigating the channel.

Chart 12352 LNM 15/18

NY-MORICHES BAY, SHINNECOCK BAY AND STATE BOAT CHANNEL (REVISED 39/16)

Shoaling has been reported in Moriches Bay along the Long Island Intercoastal Waterway in the vicinity of Moriches Bay Buoy 17, 18, 21, 26, 27, 28 and 29 extending the entire width of the channel and at any tide level. The most severe area of shoaling can be found between buoys 26 and 27 and is less than 3 ft. Shoaling is also reported in Moriches Inlet in the vicinity of Moriches Inlet East Cut Buoys 3E and 5E. Mariners should be aware that the Aids to Navigation in these areas have been deemed unreliable due to shoaling and mariners are advised to seek alternate routes. If transiting these areas, do so only at high tide and proceed slowly and with extreme caution.

Chart 12352 LNM 39/16

NY-SHINNECOCK BAY TO EAST ROCKAWAY INLET-SLOOP CHANNEL

Shoaling has been reported in the vicinity of Sloop Channel Beacon 21 (LLNR - 31100). All mariners are requested to use caution when transiting the area.

Chart 12352 LNM 49/17

NY-LONG ISLAND SOUND –MILTON HARBOR

Severe Shoaling has been reported in Milton Harbor. Mariners are advised to proceed with caution while transiting the area.

Chart 12364

NEW JERSEY SHOALING

NJ-NAVESINK RIVER

Recent surveys have shown significant shoaling in the Navesink River. Shoaling exists across the entire reach beginning at the entrance to the Navesink River to Navesink River Buoy 24. Least depths of 2.3 feet to 5.8 feet extending into channel and throughout the waterway. Navigation of the area requires extreme caution due to the encroaching nature of the shoal.

Chart 12325 LNM 01/22

NJ-SHREWSBURY RIVER

Shoaling has been reported in the vicinity of Shrewsbury River Channel Lighted Buoy 5 (LLNR - 35755). All mariners are requested to use caution when transiting the area.

Chart 12325 LNM 50/21

SUMMARY OF ONGOING DREDGING AND MARINE CONSTRUCTION PROJECTS

Arranged by State, North to South, and newest information on top (for each State).

Updated 01/11/2023

NEW OR UPDATED INFORMATION

New, updated or very important information in this enclosure will be highlighted in yellow.

MAINE

ME-KENNEBEC RIVER-BATH

General Dynamics Bath Iron Works will be conducting maintenance dredging at Pier 2, Pier 3 and the Dry Dock Landing Grid #1 at Bath Iron Works in Bath, Maine located in the Kennebec River. Dredge spoils will then be barged north through the Sagadahoc Bridge to the Reed & Reed laydown area on the west bank of the river, in position 43-54-25.87N 069-48-47.20W; 43-54-23.20N 069-48-49.10W; 43-54-09.00N 069-48-47.30W, from **January 9 to February 17, 2023**. Dredging will be occurring during weekday daylight hours with one or two off-loads per day expected. Equipment on scene will be 3 spoil barges, 1 crane barge, up to two tugboats, monitoring VHF-FM CH 16 for all concerned traffic. Mariners are advised to use caution and transit at slow speed to minimize wake when transiting the area.

Chart 13298 LNM 52/22

ME-CASTINE BAY-BAGADUCE RIVER

University of Maine, Dept. of Civil & Environmental Engineering will be conducting, coastal engineering research into tidal intrusion fronts effects on wave environments, from **December 12, 2002, to February 12, 2023**, 24 hours a day seven days a week. Equipment on scene will be coastal research instrumentation with accompanying moorings and flotation buoys, in position 44-22-47.978N and 068-48-59.752W. For more information on this research project please contact Dr. Kimberly Huguenard at Kimberly.huguenard@maine.edu. Mariners are advised to use caution and transit at slow speed to minimize wake when transiting the area.

Chart 13309 LNM 50/22

ME-ROCKLAND

Prock Marine will be conducting dredging and ocean water disposal operations at the Rockland, Municipal Fish Pier, in position 44-6-9.468N 063-6-37.368W, from **November 8, 2022, to March 1, 2023**, 24 hours a day, seven days a week. Equipment on scene will be the tug DORTHY, Prock Marine barge No. 5, Scow Prock 17 and a skiff boat, monitoring VHF-FM CH 10,12,13, and 16. Mariners are advised to use caution and transit at slow speed to minimize wake when transiting the area.

Chart 13307 LNM 43/22

VERMONT

NONE TO REPORT

NEW HAMPSHIRE

NH-PISCATAQUA RIVER-NEWINGTON-LITTLE BAY

DAKA Properties, LLC, will be conducting dredging operations in Little Bay, NH, in position 43-07-15.95N, 070-50-04.89W, from **January 3 to March 15, 2023**, seven days a week, between 6:00am to 12:00am. Equipment on scene will be a 40' x 100' dredge barge, a 30' x 120' hopper barge, a 26' push boat, and work skiffs. All working vessels will be monitoring VHF-FM CH 18, for any concerned traffic. Barges will be moved as tide allows to offload facility in Newington, NH. Any vessel or barge movements that encounter other traffic shall be coordinated via VHF-FM CH 13. Mariners are advised to use caution and transit at slow speed to minimize wake when transiting the area.

Chart 13285 LNM 51/22

NH- PISCATAQUA RIVER-NEWINGTON

CDM Constructors Inc. will be dismantling a former fuel pier, on the Piscataqua River, in Newington, NH, in position 43-6-27.16N, 070-47-52.85W, from **July 19, 2022 through May 31, 2024**. Equipment on scene will be sporadic depending on phase of project. Two working barges will be mobilized for crews and heavy equipment (excavator and Lull). Miscellaneous support vessels may also be present, monitoring VHF/CH-13 and 16. Work barges will be centralized to work areas only and will not impede navigation. Mariners are urged to transit at their slowest safe speed to minimize wake and proceed with caution.

Chart 13285 LNM 29/22

MASSACHUSETTS

MA-LYNN-ROCKPORT

Edge Cable Holdings USA, LLC, is announcing the start of in-water work related to cable installation for the Amitié Fiber Optic Cable Project. This work will include pre-lay clearance activities and offshore cable installation in Massachusetts State Waters from Lynn to Rockport and nearshore activities exclusively in Lynn. Nearshore activities are anticipated to commence **February 1, 2023, and occur until February 28, 2023**, in position 42-41-6.9N, 070-00.0W. Pre-lay clearance activities are anticipated to commence February 1, 2023, and occur over a 2-day time period within state waters. Offshore cable installation is anticipated to commence February 3, 2023, and occur over a 4-day time period within state waters. Pre-lay clearance and offshore installation activities will start in Lynn and end in Rockport during these timeframes. Post-lay jet burial is targeted to occur within the municipalities of Lynn and Manchester-by-the-Sea between February 23, 2023, and February 28, 2023. The provided dates are subject to change based on suitable installation conditions. Equipment on scene throughout the project will be the Atlantic Merlin, Cable ship DECISIVE, M/V Ile De Molene, FV Karoline Marie, and FV Becky Lynne and will be monitoring VHF-FM CH 16 for any concerned traffic. Additional information about Project activities, contact information, and schedule updates can be accessed by visiting the following website: <https://amitie-submarine-cable-erm.hub.arcgis.com/> Mariners are advised to use caution and transit at slow speed to minimize wake when transiting the area.

LNM 02-23

MA-CAPE COD BAY-DENNIS-SESUIT HARBOR

Barnstable County Dredging will be conducting dredging operations in the Sesuit Harbor, Dennis, MA, in position 41-45.21N 070-09.15WW, from **January 16 to 31, 2023**. Dredging will run Monday through Saturday between 7:00am to 4:00pm. Equipment on scene will be the Cod Fish II', Push boat – Bradbury and several support boats and approximately 1,500 feet of pipeline. The dredge boat Cod Fish II is stationary and has limited maneuverability. The discharge pipe will be floating at times during dredging operations and may be blocking the channel. Mariners are requested to give adequate clearance to the equipment at all times and maintain communications as needed, through VHF-FM CH 16, and 18. Mariners are advised to use caution and transit at slow speed to minimize wake when transiting the area.

Chart 13246 LNM 02/23

MA-MERRIMACK RIVER-HAVERHILL-Updated 10/31/2022

The Merrimack Valley Regional Transit Authority will be conducting riverbank stabilization operations, along the Merrimack River, at 85 Railroad Avenue, Haverhill, MA, in position 45-45-59.187N, 071-5-29.727W. Work will run between **August 15-December 30, 2022**, Monday through Friday, from 7:00am-3:00pm. Equipment on scene will be land based construction equipment, vibratory hammer, backhoe, and a bobcat. The work will not impede the safe navigation on the river. Mariners are urged to transit at their slowest safe speed to minimize wake and proceed with caution.

Chart 13274 LNM 32/22

MA-SPRINGFIELD-CONNECTICUT RIVER CROSSING PROJECT – UPDATE 10/31/2022

The Springfield Water and Sewer Commission continues construction and pipeline installation operations on the Connecticut River Western Agawam bank between the Memorial and South End Bridges at approximately River Mile 75. Construction will consist of the installation of a pile supported access trestle with limited floating turbidity curtains extending approximately 90 feet beyond the mean annual high-water mark into the Connecticut River. Phase III of construction has commenced. Connecticut River – Mile 73 Springfield/Agawam: Construction & Dredging for Pipeline Crossing Activities shall commence on or about **June 1, 2022, to January 15, 2023** pending weather and production. Temporary pile to support environmental curtains shall extend 600 feet into the river from the West bank and 1000 feet north tapering from the West bank shore to the center of the river. Piles shall be lighted with navigational steady all-round white lights. Construction equipment consist of,

- 1 150-180 Ton Crane Mount on 70' x 80' x 7' Poseidon (2) Spud Barge
- 2 215,000 LB Komatsu 1250 Excavator Dredge Barge w/ (4) powered spuds
- 3 30'x 80' x 7' Material / Environmental Controls - Poseidon section barges
- 1 300HP-400HP shallow water push boat.
- 1 225 HP Sea Bee 180-degree hydraulic thruster-master
- 1 60hp work boat
- 1 8'x10'x3' Environmental work barge w/ motor
- 1 DOC Inspection Boat (Daniel O'Connell's Sons)

Clear navigable passage for boaters will be maintained on the eastern side of the river. Due to barge mounted equipment and Dive operation safety concerns; Mariners are advised to exercise extreme caution when transiting the area proceeding at headway speed at "No Wake" and to monitor VHF- FM Channels 13/16. For more information mariners may contact J.F White Contracting Co at (617) 454-1832 or Project Manager Robert Pellerin at (508) 905-9582. Additional Questions concerning this project may be directed to Mr. Gus O'Leary at (617) 498-4649 or the on scene contractor, J.F. White Company at (617) 699-5063. On scene work vessel may be contacted via VHF-FM 05 or 07 Mariners are urged to use caution while transiting the area.

LNM 20/21

MA-NANTUCKET SOUND-Updated 10/29/2022

On or about the 30th of October in preparation for Cable Laying Operations there will be a construction barge and a materials barge along with tugs KODIAK and BUCKY performing Diving Operations at the HDD Cable ducts to get the cables ready for connection and pull-in to the beach. Additionally, six smaller workboats and a Crew Transfer Vessel will assist in these operations. Subsequently, the Cable Barge ULISSE will be towed to site by the NICOLE FOSS and begin conducting cable laying operations approximately 700m (0.4nm) off Covell's Beach, Barnstable. The cable will be pulled to shore by an onshore winch, once secured the ULISSE will lay and bury the cable away from the beach out to the Cape Poge area. Attending the ULISSE cable laying operations will be the support vessels MENA C & MARTINE P that will be performing anchor handling for the operations. Two local fishing vessels will be operating around the activities as safety vessels to monitor traffic and facilitate the safe movement of fishing vessels, recreational craft, or other transiting vessels, around the work sites and project vessels. All Mariners transiting or fishing in the area are requested to give a wide berth to the vessels as they are limited in their ability to maneuver, and the Cable layer ULISSE will have gear out 1500m ahead of the vessel and up to 1500 meters behind the vessel. The ULISSE will operate on a 5-point mooring spread utilizing the full width of the Offshore Export Cable Corridor (OECC). The mooring spread will consist of four positioning anchors positioned up to 1 km or 0.54 nm from the barge and a single pulling anchor positioned up to 1.5 km or 0.82 nm. Her anchors will be deployed with pennant buoys and will be marshalled by various support vessels. Vessels in the vicinity of the operations are requested to operate in a manner as to not endanger the vessel or associated equipment. Passing arrangement can be made via VHF with the vessels on VHF-FM CH 13 and 16. Additional information on this project can be viewed at the following link: <https://www.vineyardwind.com/mariners-updates/70>



Chart 13237 LNM 42/22

MA-NANTUCKET

Robert B. Our Co. Inc. will be conducting pier improvements and repairs to the Nantucket Town Pier in position 41-9-55.2096N 070-3-14.724W, from **October 5, 2022, to May 31, 2023**, 24 hours a day 7 days a week, between 6:00am to 6:00pm. Equipment on scene will be the barge TYRONE, scow COVE POINT, LINKBELT 138 CRAWLER CRANE, tug ROBERT B, push boats MR. MAGOO and MR. BOJANGLES, and the work skiff SERM. All working vessels will be monitoring VHF-FM CH 13 and 16, for all passing and movement arrangements. Mariners are advised to use caution and transit at slow speed to minimize wake when transiting the area.

Chart 13241 LNM 40/22

MA-SCITUATE HARBOR-Update 9/27/22

Scituate Historical Society will be conducting a restoration project of the lantern room on Old Scituate Light from **October 3, 2022, to August 30, 2023**. During this time, the light will be temporarily disestablished and extinguished. Mariners are advised to use caution when transiting the area. Information on the Scituate Historical Society can be found at scituatehistoricalsociety.org or by calling 781-545-1083.

Chart 13269 LNM 38/22

MA – NEWBURYPORT HARBOR – DREDGING- Update 12/6/2022

Mariners are advised that H&L Contracting will be conducting dredging operations in Newburyport Harbor, MA from **September 28, 2022, to March 15, 2023**. The 20” Dredge OYSTER BAY will be performing dredging in the channel outside of the inlet at 42-49-03” N 70-48-01” W. with the dredge pipe located along the south side of the inlet. The 16” Dredge FINN will be performing dredging at multiple locations in the main harbor channel with the dredge pipe located on the south side of the channel. All dredge pipes will be marked and lit I.A.W. Coast Guard Regulations. Channel crossings will be provided with the dredge pipe submerged and marked with temporary red and green buoys. Work hours are 24 hours a day, 7 days a week. There will be two dredges, multiple push boats, skiff, booster pump barge, equipment barge, and dredging pipeline on scene. All marine equipment operators will be monitoring VHF-FM Channel 63 and Channel 16 and 13. Dredge and work vessels will monitor VHF-FM Channel 13 and 16. Mariners are advised to proceed with caution when transiting the area and are requested to limit speed to the minimum required to make way.

Chart 13278 LNM 37/22

MASSACHUSETTS - BEVERLY – SALEM- DANVERS - ESSEX BRIDGE Conduit Installation:

Mariners are advised that McCourt Construction Company will be installing new conduit lines beneath the Beverly Salem Memorial Bridge crossing the Danvers River commencing **October 3, 2022, to March 31, 2023**. Work hours will be from 9:00 a.m. to 6:00 p.m. Monday thru Friday. Equipment on scene will consist of a Snooper truck with suspended bucket platform and multiple small tending vessels, no impact to Navigation is anticipated. For more information Mariners may contact Mr. Tom Pyle at (617) 620-5974 on scene vessels will be monitoring VHF-FH CH 12. Mariners are urged to use caution when transiting and to proceed at headway speed no wake in the vicinity of repair vessels that may be present.

Chart 13276 LNM 37/22

RHODE ISLAND

RI-NARRAGANSETT BAY

Regent Craft Inc. will be testing a prototype wing-in-ground-effect (WIG) craft in Narragansett Bay beginning **July 7, 2022, until approximately May 31, 2023**. The testing areas include the waters of Narragansett Bay, east and west of Prudence Island. Testing of the prototype will last approximately 2-4 hours, Monday through Friday with occasional tests on weekends and occur during daylight hours only. All mariners are advised to use caution when transiting through these areas and avoid these areas if possible while testing is ongoing to deconflict traffic conditions. The vessel can be reached on VHF channel 13/16. For further information, please contact U.S. Coast Guard Sector Southeast New England at (508) 457-3211.

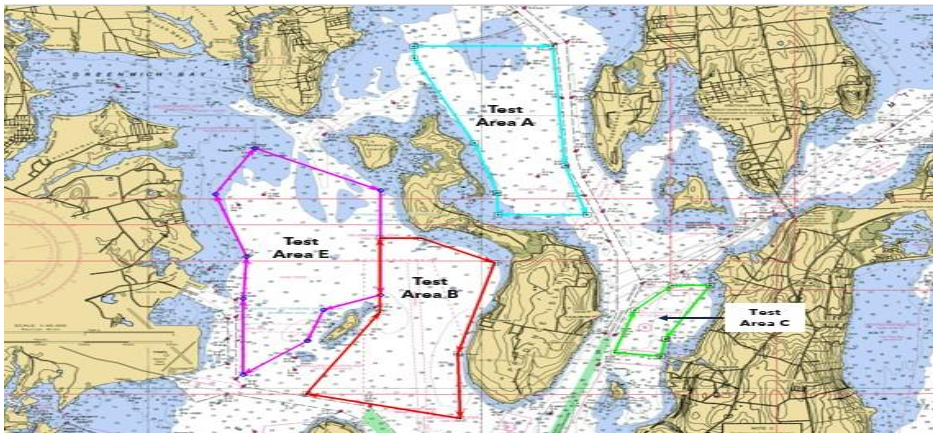

LNM 48/22

RI-POINT JUDITH POND

Patriot Marine will be conducting improvement dredging in Point Judith Pond and Harbor Refuge, in position 41-22-34.66N and 071-30-39.53W, with transport to the Mantunuck Nearshore Disposal site, from **November 30, 2022, to January 31, 2023**, 24 hours a day, seven days a week. Equipment on scene will be the dredge 410, scow 144 and 143, and a tugboat, monitoring VHF-FM CH 13, for all concerned traffic and are requesting a 10-minute notice for vessel movement requests. Mariners are urged to transit at their slowest safe speed to minimize wake and proceed with caution.

Chart 13219 LNM 46/22

RHODE ISLAND – PROVIDENCE RIVER – SEAWALL REPAIRS

The Narragansett Electric Company and JF Brennan Company are performing repairs to the Seawall Bulkhead in Providence: 41-48-00.3N 71-23-31.3W. Work will take place from **March 14, 2022, to April 1, 2023**. A Crane Spud Barge, a Materials Barge, Work Floats and Marine Vessels operating in the Work Area defined below to perform demolition activities on the existing seawall and install a new sheet pile wall. Work hours are 6:00am to 6:00pm. Project operations will monitor VHF Channels 13 and 16 during working hours. Questions or concerns may be directed to the Project Manager, Kristian Theriault at 401-378-1876 (kristian.theriault@nationalgrid.com). Mariners should use caution when transiting the area.

Chart 13225 LNM 10/22

CONNECTICUT

CT-THAMES RIVER-GROTON

General Dynamics Electric Boat will be conducting sensitive exterior repair on vessel near the waterline at General Dynamics Electric Boat Graving Docks on the Thames River in Groton, CT, in position 41-20-36.772N 072-4-56.838W. Work will commence on **January 16 to 30, 2023**, 24 hours a day seven days a week. Equipment on scene will be a vacuum pump pier side with associated lines running to the vessel. Mariners are advised to use caution and transit at slow speed to minimize wake when transiting the area.

Chart 13213 LNM 02/23

CT-LONG ISLAND SOUND-BRANFORD-PINE ORCHARD HARBOR

Patriot Marine, LLC will be conducting maintenance dredging, in Pine Orchard Harbor, in position 41-15-52.1N 072-46-20.2W, from **January 12 to 31, 2023**, 24 hours a day seven days a week. Transport and disposal of the dredging material will be taken to the Central Long Island Sound Disposal Site. Equipment on scene will be the tug MULBERRY and the dredge 562, monitoring VHF-FM CH 13 for any concerned traffic. Mariners are advised to use caution and transit at slow speed to minimize wake when transiting the area.

Chart 12373 LNM 02/23

CT-BRIDGEPORT HARBOR-BARNUM LANDING-Update 12/19/22

L/B JILL will be conducting crane operations alongside the pier at Barnum Landing, in Bridgeport Harbor, in position 41-10-9.127N 073-10-25.269W, from **December 20, 2022, to January 16, 2023**, seven days a week 24 hours a day. Equipment on scene will be the LB JILL and SEACOR BRAVE, monitoring VHF-FM CH 13 and 16. The edge of the turning basin is approximately 90' from the face of the Eastern Dock at Barnum Landing. With a beam of 135' the JILL will be approximately 45' across the edge of the northeastern side of the turning basin. While at the prescribed berth, the JILL will be outside of the Bridgeport Reach. Per the chart, the Bridgeport Reach has a width ranging from 400' to 600' in its widest point to the west of Barnum Landing. While alongside the Eastern Dock, the JILL will not impede on vessels transiting the Bridgeport Reach. Mariners are advised to use caution and transit at slow speed to minimize wake when transiting the area.

Chart 13213 LNM 48/22

CT-CONNECTICUT RIVER-THAMES RIVER-SUBASE

Weeks Marine will be conducting dredging operations near SUBASE Pier 15, in positions 41-23-52N, 72-5-40WN, 41-23-1N, 072-5-22W, from **December 2, 2022, 2022 to January 31, 2023**, seven days a week, 24 hours a day. Equipment on scene will be WEEKS 551, WEEKS 259, and WEEKS 256, monitoring VHF-FM CH 67, for all concerned traffic and passing arrangements. Mariners are urged to transit at their slowest safe speed to minimize wake and proceed with caution.

Chart 13213 LNM 47/22

CT-LONG ISLAND SOUND-GUILFORD HARBOR

Patriot Marine will be conducting maintenance dredging activities in Guilford Harbor with transport and disposal at the Central Long Island Sound Disposal Site in position 41-16-18.35N 072-39-56.43W from **November 30, 2022, to February 28, 2023**, 24 hours a day, 7 days a week. Equipment on scene will be the Dredge 562 and a tug and push boat. The vessels will be monitoring VHF-FM CH 13 and will need a 10-minute warning to move. Mariners are urged to transit at their slowest safe speed to minimize wake and proceed with caution after passing arrangements have been made with the dredge.

Chart 12373 LNM 47/22

CT-STAMFORD-COVE ISLAND MARINA

Lucianos Excavation, Inc. will be conducting upland-based maintenance dredging with upland beach nourishment, at the Cove Island Marina Channel, Stamford, CT in position 41-2-38.42N and 073-30-13.70W, from **November 28, 2022, to January 31, 2023**, seven days a week, 24 hours a day. Equipment on scene will be an upland-based long reach excavator with digging bucket. Mariners are urged to transit at their slowest safe speed to minimize wake and proceed with caution.

Chart 12368 LNM 46/22

CT- LONG ISLAND SOUND- BRANFORD

Skellig Glas Archaeology LLC will be conducting kelp farming in Long Island Sound off of Branford, Connecticut southeast of Indian Neck and approximately 16500 feet northwest of Gangway Rock, in position 41-14-40.106N 072-47-44.064W; 41-14-39.933N 072-47-36.214W; 41-14-32.197N 072-47-36.402W; 41-14-34.166N 072-47-44.278W, from **November 5, 2022, to May 28, 2023**, 24 hours a day seven days a week. Equipment on scene will be Two (2), 500 foot-long longlines anchored at each end and in the middle with two 300-pound anchors (a total of 6 anchors per long line; 12 anchors in all) in water depths of between 19 feet mean lower low water (MLLW) and 25 feet mean high water (MHW). Mariners are advised to use caution and transit at slow speed to minimize wake when transiting the area.

Chart 12373 LNM 43/22

CT-NEW LONDON HARBOR

Cashman Dredging and Marine Contracting Company, LLC will begin mobilizing equipment into New London Harbor for dredging work for the Infrastructure Improvements to Connecticut State Pier Project. Dredging for the project is expected to begin on or about **October 1, 2022, to January 31, 2023**. Dredging will occur along the Connecticut State Pier to the west of the Federal Channel and just South of the Gold Star Memorial Bridge. Equipment for the project will include the following: WOOD 1, Clamshell Dredge, a crane barge, 6 material barges, SURVEY 2 survey vessel, and associated crew boat and tugboats. Mariners are urged to transit at their slowest safe speed to produce no wake and proceed with caution past the dredging site.

Chart 13212 LNM 39/22

NEW YORK

NY-LONG ISLAND SOUND-STONY BROOK HARBOR-Updated 1/10/23

H&L Contracting LLC. Will be conducting cutter suction dredging operations at the Stony Brook Harbor, Porpoise Channel and Yacht Club Spur, in position 40-55-05.39N 073-09-51.49W and 40-55-25.69N, 073-08-55.68W, from **December 12, 2022, to February 23, 2023**, 24 hours a day seven days a week. Equipment on scene will be the dredge FINN and tugs ON THE ROCKS and MIKE. All working vessels will be monitoring VHF-FM CH 63 and 13 and are requesting a 30-minute advance for all movement requests. From the two dredging areas, pipelines will be connected aft of the dredge, pumping the dredged material to Schubert's Beach with spar buoys marking the dredge pipe. Mariners are advised to use caution and transit at slow speed to minimize wake when transiting the area.

Chart 12362 LNM48/22

NY-EAST ROCKAWAY-ROCKAWAY-Update 1/9/23

Great Lakes Dredge and Dock Co. LLC will be conducting dredging operations in East Rockaway Inlet to Rockaway Inlet, Atlantic Shore Front, Rockaway, from **August 12, 2022, to January 31, 2023**, 24 hours a day, seven days a week. Equipment on scene will be the dredge ILLINOIS, DERRICK 70, Tending tugs, CHARLOTTE V, MAVERICK, CANDIACE L, survey boats MIAMI RIVER and MUSKEGON RIVER. All working boats will be monitoring VHF-FM CH 5, 13, and 16. Mariners are urged to transit at their slowest safe speed to minimize wake and proceed with caution after passing arrangements have been made.

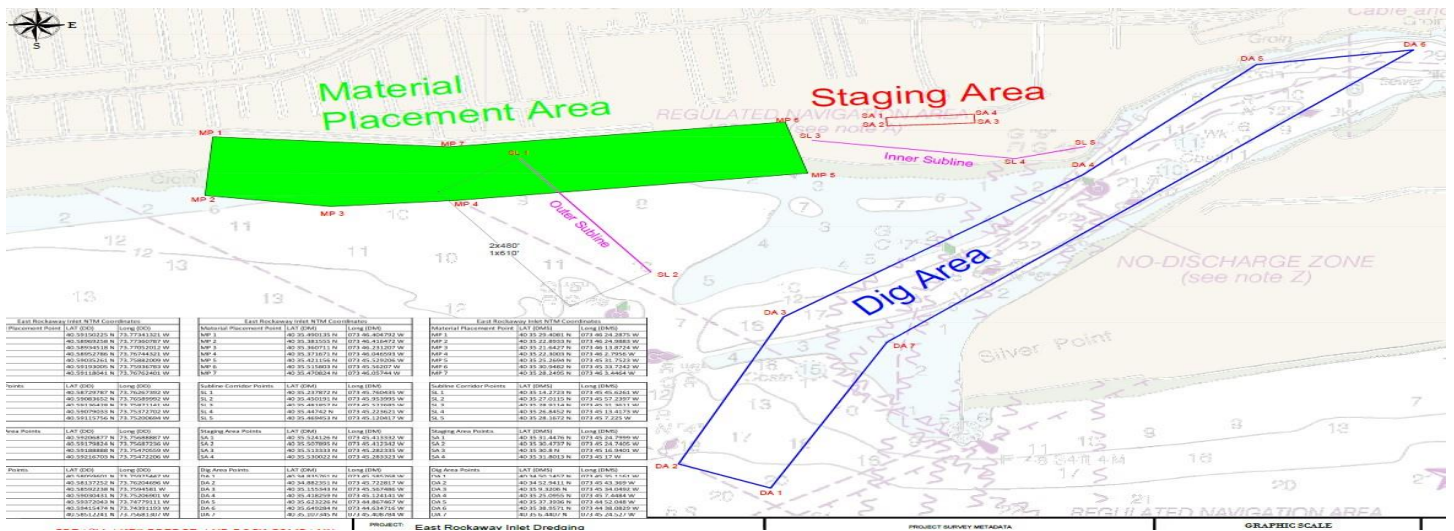

LNM 32/22

NY-BROOKLYN-GOWANUS CANAL

Aquifer Drilling and Testing, Inc. will be conducting geotechnical survey operations in the Gowanus Canal under and near the 9th Street Bridge, from **January 9 to 31, 2023**, between 5:00am to 5:00pm. Equipment on scene will be a spud barge via Millers Launch - 30' Beam X 90' LOA, shallow draft tug and crew boat, monitoring VHF-FM CH 13,14, and 16, for any concerned traffic. The tug/ barge will need a slow bell and minimum wake during periods that she is positioning. VTS will be notified of exact dates and timeframes for positioning and the working time frame becomes clearer.



Chart 12326 LNM 52/22

NY-LONG ISLAND-SHINNECOCK-MORICHES INLET

Great Lakes Dredge and Dock Company, LLC will be conducting dredging and coastal protection operations, in Shinnecock and Moriches Inlets, from **December 19, 2022, to May 1, 2023**, seven days a week, 24 hours a day. Equipment on scene will be Cutter Suction Dredge Illinois, (4-5) Tugboats, (2) Booster Barges, (1) Survey Vessel, (1) Crew Boat, (1) Derrick Barge, (1-2) Anchor Barges, monitoring VHF-FM CH 13 and 16 for all passing arrangements. Mariners are advised to use caution and transit at slow speed to minimize wake when transiting the area.

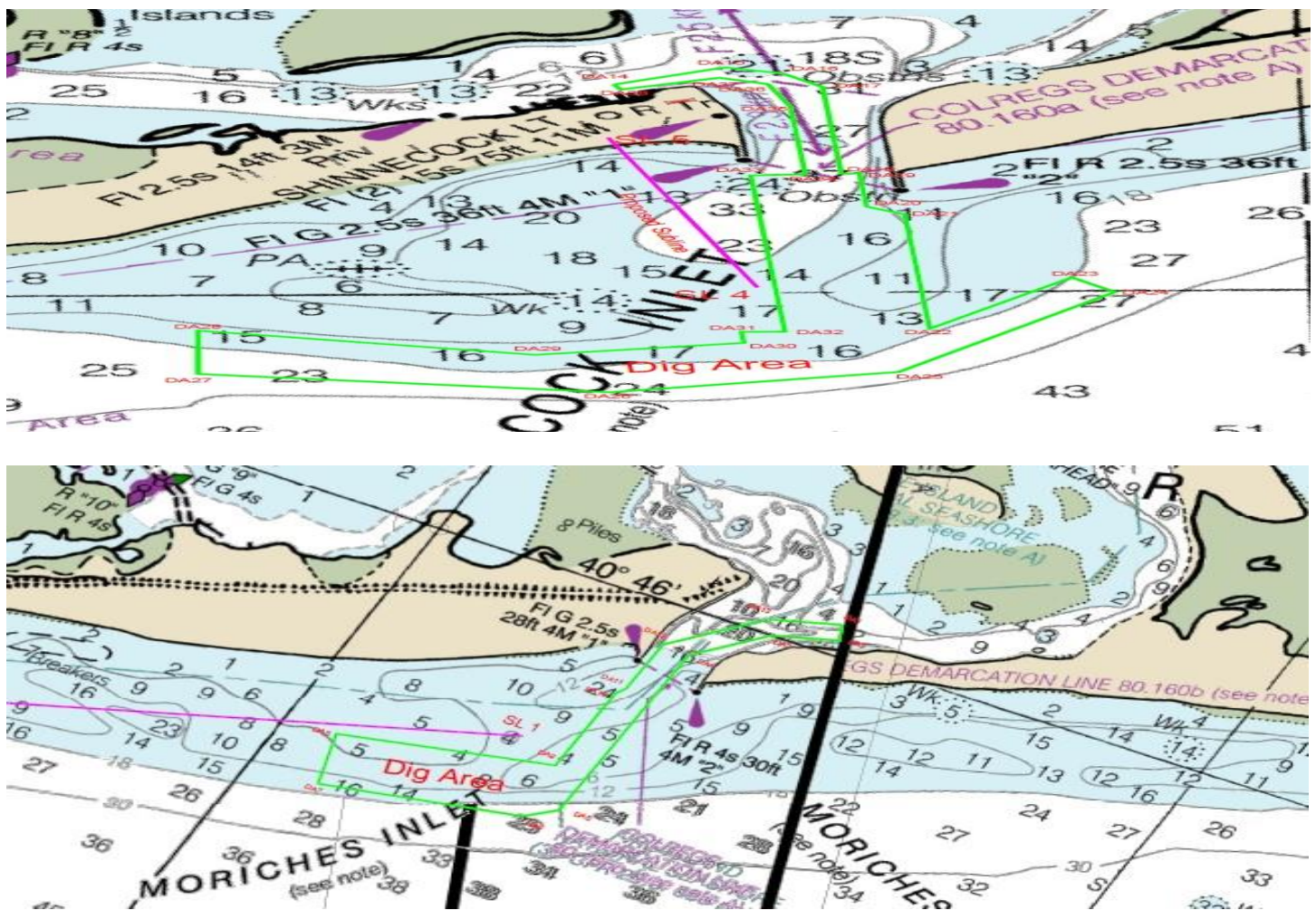

Charts 12352, 12353 LNM 50/22

NY-MANHATTAN-THE BATTERY

Reicon Group LLC will be conducting fendering rehabilitation work at the Battery Maritime Building, in position 40-42-2.257N 074-0-41.760W, between **December 12, 2022, to May 31, 2023**, Monday through Friday, from 7:00am to 3:33pm. Equipment on scene will be CB Bergen 50'x180' crane barge & 32'x110' material barge and can be reached by phone at 917-560-6100. Mariners are advised to use caution and transit at slow speed to minimize wake when transiting the area.

Chart 12327 LNM 49/22

NY- HARLEM RIVER

Reicon Group LLC will be conducting pile indicator operations in the Harlem River, in position 40-48-392N, 073-55-44.2888W, 40-48-40.536N, 073-56-2.738W, from **December 5, 2022, to January 31, 2023**, Monday through Friday, between 7:00am to 3:30pm. CB Rockland will be on scene and can be contacted at 917-560-6100, for all concerned traffic. Mariners are advised to use caution and transit at slow speed to minimize wake when transiting the area.

Chart 12342 LNM 49/22

NY-NEW ROCHELLE

Patriot Marine LLC. Will be conducting Maintenance Dredging with transport from Huguenot Yacht Club in New Rochelle, NY to Clean Earth Dredging Technologies, LLC in Jersey City, NJ, in position 40-53-21.95N 073-47-00.34W, from **November 1, 2022, to January 31, 2023**, seven days a week, 24 hours a day. Equipment on scene will be the TUG MULBERRY, TUG SCHOHARIE, TUG MISS ANNA, & DREDGE 410, monitoring VHF-FM CH 13 and 16 for all concerned traffic and is requesting a ten-minute notice, for all vessel movement requests. Mariners are advised to use caution and transit at slow speed to minimize wake when transiting the area.

Chart 12367 LNM 43/22

NY-NEW YORK CITY-EAST RIVER

JT Cleary Inc. will be conducting construction repair along the shore line of the East River, in position 40-43-52.147N 073-58-22.976W, from **October 12, 2022 to April 1, 2023**, Monday through Friday, 6:00am to 2:30 pm. Equipment on scene will be a jack up barge, monitoring VHF-FM CH 13 and 16. Mariners transiting the work area are urged to exercise extreme caution, travel at the slowest safe speed to minimize wake, and proceed with caution after passing arrangements have been made.

Chart 12339 LNM 42/22

NY-LONG ISLAND-FIRE ISLAND INLET-MONTAUK

Great Lakes Dredge Co. will be conducting dredging and pumping via two booster pump plants and submerged pipeline approximately 800,000 cubic yards of material from the Fire Island Inlet Channel, with beach placement along the Atlantic shoreline of Robert Moses State Park, NY, from **October 19, 2022, to March 31, 2023**, 24 hours a day seven days a week. Equipment on scene will be the Cutter Suction Dredge ILLINOIS, (4-5) Tugboats, two booster barges, survey vessel, crew boat, derrick barge and an anchor barge, monitoring VHF –FM CH 13 and 16. Mariners transiting the work area are urged to exercise extreme caution, travel at the slowest safe speed to minimize wake, and proceed with caution after passing arrangements have been made.

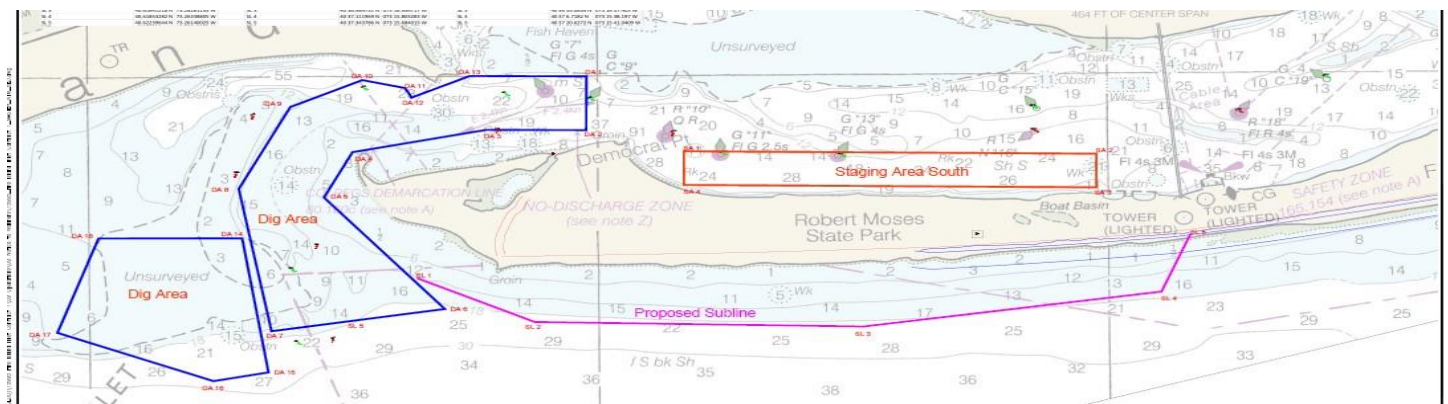

Chart 12352 LNM 42/22

NY-LONG ISLAND-WAINSCOTT BEACH

Cashman Dredging and Michaels Trenchless Inc. will be conducting Pile Driving, Horizontal Directional Drilling (HDD) off of Wainscott Beach, Long Island, NY and Towing HDPE pipe from Qounset, RI to work site off Wainscott Beach, Long Island, NY, in position 40-55-24.74N 072-13-55.73W, from **October 31, 2022 to March 30, 2023**, seven days a week, between 7:00am to 7:00pm. Equipment on scene will be the Seacor L/V JILL, Seacor S/V BRAVE, S/V Windserve

Encl 2

Odyssey Tugs – Rowan McCallister, Buckley McCallister, Matthew McCallister, Rainbow, and Gaspee. The Lift Boat JILL will be spudded down in a box area. Supply Boat BRAVE will make a twice weekly run from Bridgeport, CT to the work site for crew change and supplies, monitoring VHF-FM CH 13 and 16. Mariners are requested to transit the area with caution and minimize wake during mobilization hours 0700-1900 in Bridgeport, CT, and in the vicinity of the Lift Boat JILL.

Chart 12358 LNM 42/22

NY-LONG ISLAND SOUND- RYE-MILTON HARBOR

Patriot Marine LLC will be conducting maintenance dredging in Milton Harbor, Rye, NY in position 40-57-18.04N 073-41-37.44W, from **October 24, 2022, to January 31, 2023**, seven days a week 24 hours a day. Equipment on scene will be the tug, MULBERRY, SCHOHARIE, SARA, and the dredge 410, monitoring VHF-FM CH 13 and will be transporting and disposing of dredge material, at the Western Long Island Disposal Site (WLDS). Mariners are advised to use caution and transit at slow speed to minimize wake and are asked to give the dredging equipment a ten-minute notice for all movement requests.

Chart 12367 LNM 42/22

NY-NEW YORK CITY-THE BATTERY

JT Cleary Inc. will be conducting diver operations at the Battery in New York City, NY, in position 40-42-4.80N 074-0-52.41W, from **October 10, 2022, to May 10, 2023**. Equipment on scene will be an 80'x50' jack up barge, moored at bulkhead not in navigational channels, monitoring VHF-FM CH 4. Mariners are urged to transit at their slowest safe speed to produce no wake and proceed with caution.

Chart 12327 LNM 39/22

NY-LONG ISLAND-MORICHES BAY

Dredgit Corporation will be conducting maintenance dredging from **October 11, 2022, through January 15, 2023**, 24 hours a day, seven days a week. Dredging and associated pipeline will be in the vicinity of the Long Island Federal Navigation Channel, Moriches Bay in the following positions: 40-46-44.9831N 072-45-45.7376, 40-46-44.034N 072-45-45.374W, 40-47-09.046N 072-43-52.340W, 40-47-09.995N 072-43-52.703W. Equipment on scene will be, 18' Ellicott Dredge with Idler Barge & Swing Anchors, 18' Ellicott Booster Pump with flex hoses, 20' Dredge Pipeline and multiple work boats, monitoring VHF-FMCH 7,8,13, and 16. The dredge will minimize interference with the use of the Federal Navigation Channel. Dredgit will shift or move the dredge and interrupt dredging operations to accommodate the movement of vessels and floating equipment, if necessary. Mariners are urged to use extreme caution and transit the dredge area at their slowest safe speed to create minimum wake. Mariners are encouraged to utilize the vessels navigational aids, navigational lights and day shapes to determine safest passage. The dredge pipeline will be clearly marked with floats and amber blinking lights.

Chart 12352 LNM 38/22

NY- BROOKLYN-ATLANTIC BASIN

Trevcon Construction Company will be conducting steel pipe and precast pile driving, fender and concrete deck installation, in position 40-40.998N 074-0.658W, in the Atlantic Basin, Brooklyn, NY. Work will run from **September 22, 2022, to July 31, 2023**, from 6:00am to 6:00pm. Equipment on scene will be a 190'X60' crane barge and two 40'X110' material barges. Mariners are advised to use caution and transit at slow speed to minimize wake when transiting the area.

Chart 12327 LNM 38/22

NY-STATEN ISLAND-RARITAN BAY

Weeks Marine will be constructing 8 rubblemound breakwaters, north of Ward Point, East Reach approximately halfway between the shipping channel and the shoreline, in position 40-29-37.9841N 074-14-48.6976W and 40-29-54.3500N, 074-13-56.6352W, from **April 1-June 30, 2023**, Mon-Friday 5:00am to 5:00 pm. Equipment on scene will be W537 (250’x64’x16’), W80 (150’x80’x13’) W201-205 (130’x40’x11’) W291 (180’x54’x14’) LISA D. Crew boat (47’x13’x4’), JESSE O. Workboat (25’x11’x6’). The barges will remain on scene overnight and on weekends and will be properly marked and lit. W537 will be on anchors, W80 will be on spuds and all other barges will be moored alongside. Mariners operating or transiting in the area, are requested to give a 0.5 nautical mile closest point of approach and are urged to transit at their slowest safe speed to minimize wake and proceed with caution after passing arrangements have been made with the dredge. All vessels will be monitoring VHF CH 16 and 82.

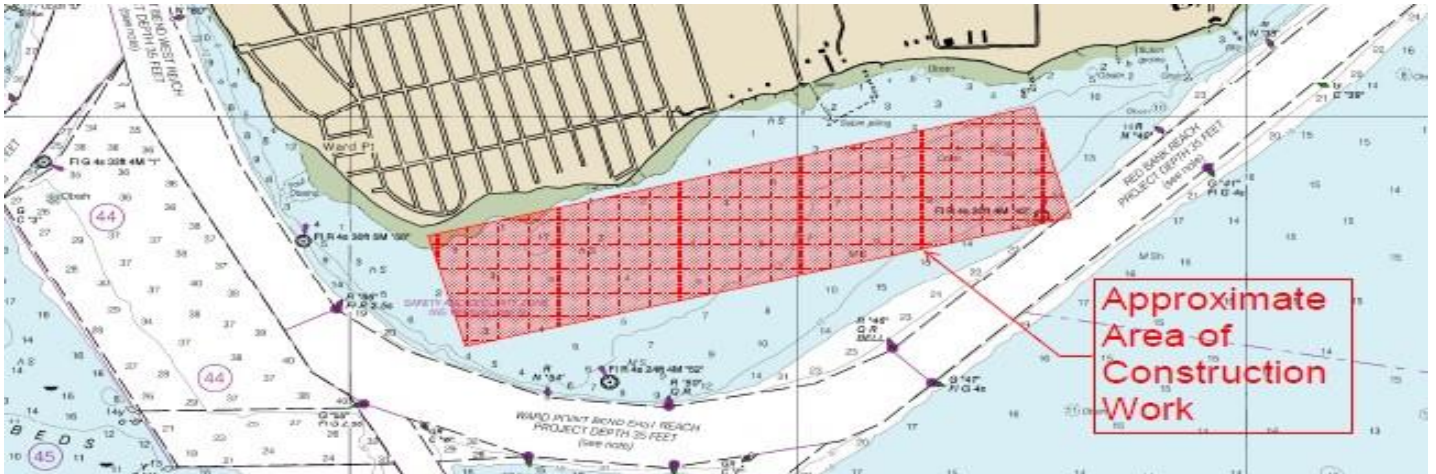

Chart 12331 LNM/20/22

NY-NYC-EAST RIVER

IPCP will be conducting esplanade, bulkhead, and park reconstruction, on the East River, Montgomery St to East 14th Street, from **January 2022 to December 2026**, 5-7 days a week, between 6:00am to 6:00pm. Equipment on scene will be Tugboat DEBRA QUINN, Inspection Boat, 290 x 40 Mooring Barges, 250 x 62 Gantry Crane Barge, Crawler Crane Barge, 150 x 60 Deck Barges, 140 x 40 Hopper Barges All moving of vessels to occur by tugboat; vessels will be moved at all times of day and night and will be monitoring VHF-CH 13 and 66. Mariners are urged to transit at their slowest safe speed to minimize wake and proceed with caution after passing arrangements have been made.

Chart 12339 LNM 20/22

NY-UPPER NEW YORK HARBOR, BROOKLYN

IT Cleary, Inc. will be conducting reconstruction of West Berth Platform, Installation of piles/ precast concrete work and demolition and reconstructive work of North Berth Platform and Inshore Return Platform in Brooklyn NY, at the OWI's Head Wastewater Treatment Plant 6700 Shore Rd. West Sludge pumping dock. In position 40-38-39.53N and 74-02-02.84W, 40-38-37.14N and 074-02-05.40W, 40-38-40.16N and 074-02-03.86W, 40-38-37.65N and 074-02-06.50W. Work will be done from **21 March 2022 to 30 December 2024**, Monday through Friday 6:00am - 6:00pm. Equipment of scene will be a Crane on barges with Spuds, material barge, hopper barges, work boats. The crew boat will be monitoring VHF-FM Channel 13 and 16 during working hours. Barges/equipment will not impede passage of any vessel. However, barges may be staged 50ft into east edge of The Bay Ridge Channel. Barges will be spudded down along shoreline. All moving of vessels to occur by tugboat. Mariners are urged to travel slowest safe speed to minimize wake.

Chart 12334 LNM: 11/22

NY-EAST RIVER-MONGOMERY STREET TO E 14 STREET

IPCRP will be conducting Esplanade, bulkhead and park reconstruction work on the East River at Montgomery and East 14th Streets, in position 40-42-54.0N/ 073-58-27.7W from **01 January 2022 to 31 December 2026**, Monday to Friday from 6:00am to 5:00pm. Equipment on scene will be tugboat, mooring barges, material handling barges, a crane barge and deck barge. Vessels will be on scene monitoring CH 13 and 66. Vessels will need a one-hour notification to move. Mariners are urged to transit at their slowest safe speed to minimize wake.

Chart 12335 LNM 50/21

NY-GOWANUS CANAL

The Gowanus Canal is closed to all recreational boating between 9th Street and Butler Street, including use of the 2nd Street public boat launch, at the direction of the U.S. Environmental Protection Agency (USEPA), the lead federal agency for the Gowanus Canal Superfund Site, due to the ongoing construction of the dredging and capping remedy of the canal until further notice unless specific advance written authorization is granted by USEPA. Contact: (212) 637-3639. For further information: <https://gowanussuperfund.com>.

Chart 12334 LNM 20/21

NEW JERSEY

NJ-NEWARK BAY

Maher Terminals will be conducting steel pile pipe installation in position 40-40-07.732N, 074-08-32.778N, from **January 23 to February 23, 2023**, Monday through Friday. Equipment on scene will remain on landside of the existing fender line and will have no impediment to vessel navigation. Mariners are advised to use caution and transit at slow speed to minimize wake when transiting the area.

LNM 02/23

NJ- SEA BRIGHT- BARNEGAT

Weeks Marnie will be conducting dredging operations and will be mobilizing equipment in the vicinity of Barnegat Inlet, NJ. The staging area will be bound by the following approximate positions:

39°46'6.66"N, 74° 7'11.88"W, 39°46'6.36"N, 74° 6'57.60"W, 39°45'37.26"N, 74° 7'8.70"W

39°45'37.98"N, 74° 6'52.50"W. Starting approximately **December 22, 2022, and continuing until approximately March 1, 2023**, the hopper dredge(s) "R.N. Weeks" and "B.E. Lindholm" will be operating three (3) nautical miles offshore of Sea Bright Beach, Sea Bright, NJ. Work limits for the Borrow Area will be the perimeter bound by the following approximate positions: 40°26'7.43"N, 73°56'34.48"W, 40°26'7.74"N, 73°54'36.65"W, 40°23'57.45"N, 73°54'36.76"W, 40°24'0.08"N, 73°56'35.78"W. Dredged material will be transported through a combination of floating and submerged line reaching between 2,500 feet to 4,500 feet offshore from Elberon Beach, NJ. The proposed pipeline corridor will be bound by the following approximate positions: 40°16'52.81"N, 73°58'54.81"W, 40°16'47.21"N, 73°57'47.97"W, 40°15'35.49"N, 73°58'2.51"W, 40°15'49.29"N, 73°59'12.66"W. Operations will continue a twenty-four (24) hours per day, seven days per week basis. The dredge and tugs will monitor marine VHF channels 13 and 16. Mariners are urged to use extreme caution and transit the area at their slowest safe speed to create minimum wake after passing arrangements have been made. Pipeline and equipment will have all required lighting for night operations.

Chart 12324 LNM 49/22

NJ-JERSEY CITY

Trevcon Construction Company Inc. will be installing precast concrete elements, placement of stone and structural concrete work at the Global Container Terminal, Jersey City, in position 40-40-8.900N 074-4-30.312W, from **October 24, 2022, to December 31, 2024**, between 5:00am to 7:00pm. Equipment on scene will be multiple barges and work vessels, monitoring VHF-FM CH 13 and 16 for any vessel passing or movement request. Mariners are urged to transit at their slowest safe speed to produce no wake and proceed with caution.

Chart 12316 LNM 39/22

NJ-NEWARK BAY-PORT NEWARK CHANNEL

Donjon Marine Co. Inc. will be conducting maintenance dredging in Newark Bay and Port Newark channel, in position 40-44.626N, 074-8-31.621W. Dredging will run between **August 19, 2022, to February 2023**, seven days a week, 24 hours a day. Equipment on scene will be (1) Dredge, (1) tending tug, hopper scows, (1) towing tug for loaded scows, (1) crew boat, monitoring VHF-FM CH 13, 14, and 78. This is a move on demand dredge project, Donjon will maintain a tending tug on the dredge site to move the dredge & scow if needed. Mariners are urged to transit at their slowest safe speed to minimize wake and proceed with caution.

Chart 12327 LNM 32/22

ATLANTIC OCEAN

OFFSHORE WIND ENERGY/ONGOING WORK

Updated 1/11/2023

New information highlighted in Yellow

MA- SOUTHEAST OF MARTHA'S VINEYARD-SOUTHWEST OF NANTUCKET- OCS-A-501

Vineyard Wind will be utilizing the F/V BEAST OF BURDEN to deploy one Passive Acoustic Monitoring (PAM) device as part of the University of New Hampshire multi-year study to record ambient sound and marine mammal species vocalizations in OCS-A 501 lease area, in position 41-3-45.18N 070-28-27.768W from **January 2023 to 2025**. The PAM device is approximately 2 meters high and 1.7 meters wide and weighs 800 kg with anchor. The device consists of the body and four arms that extend vertically to a central lift point. The device is connected via acoustic releases to the anchor, which consists of a steel triangle assembly with five 20 kg weight plates on each point of the triangle. The BEAST OF BURDEN will be monitoring VHF-FM CH 16 for any concerned traffic. More information about this project can be found on the following link: [PASSIVE ACOUSTIC MONITORING DEVICE DEPLOYMENT — Vineyard Wind](#)

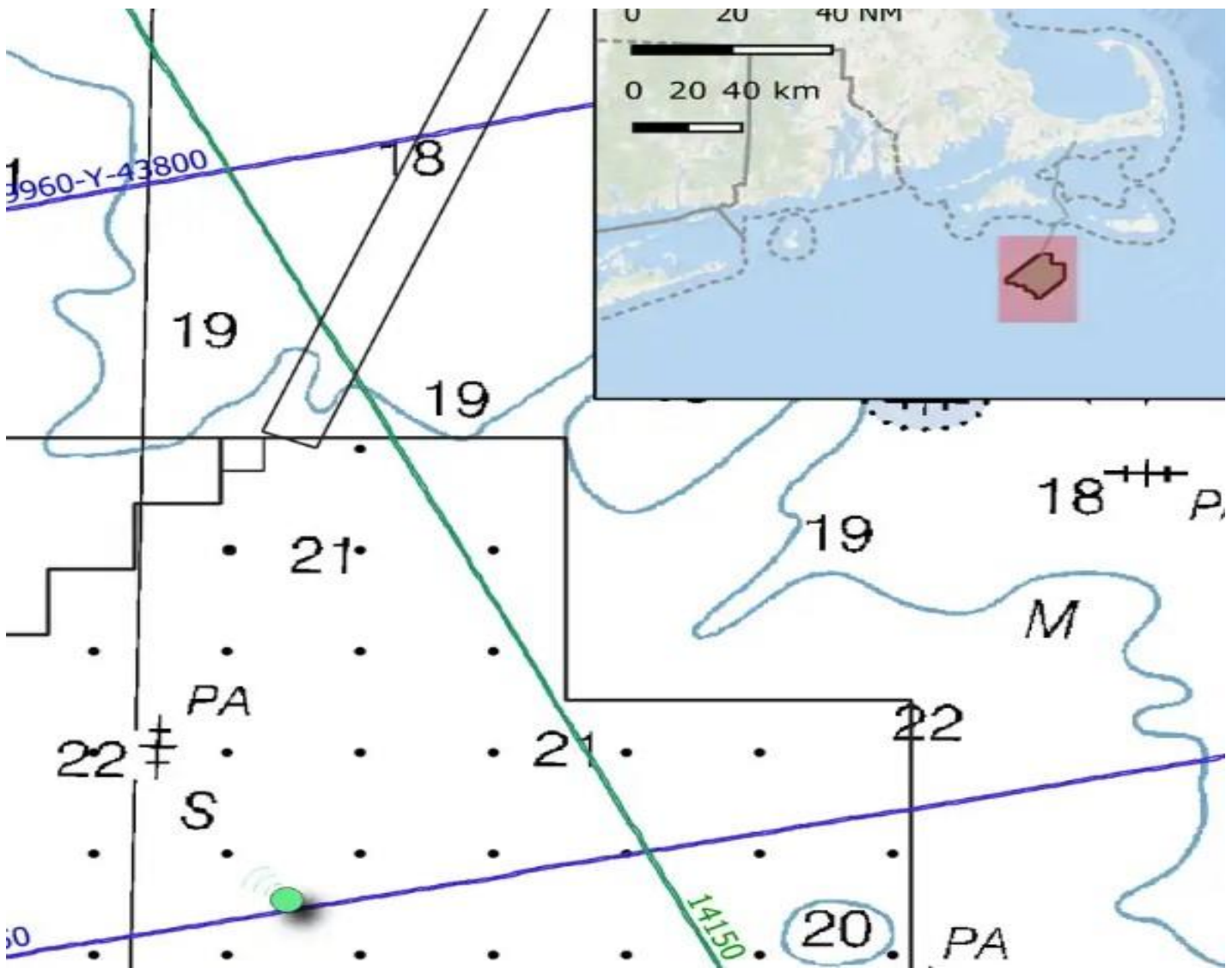
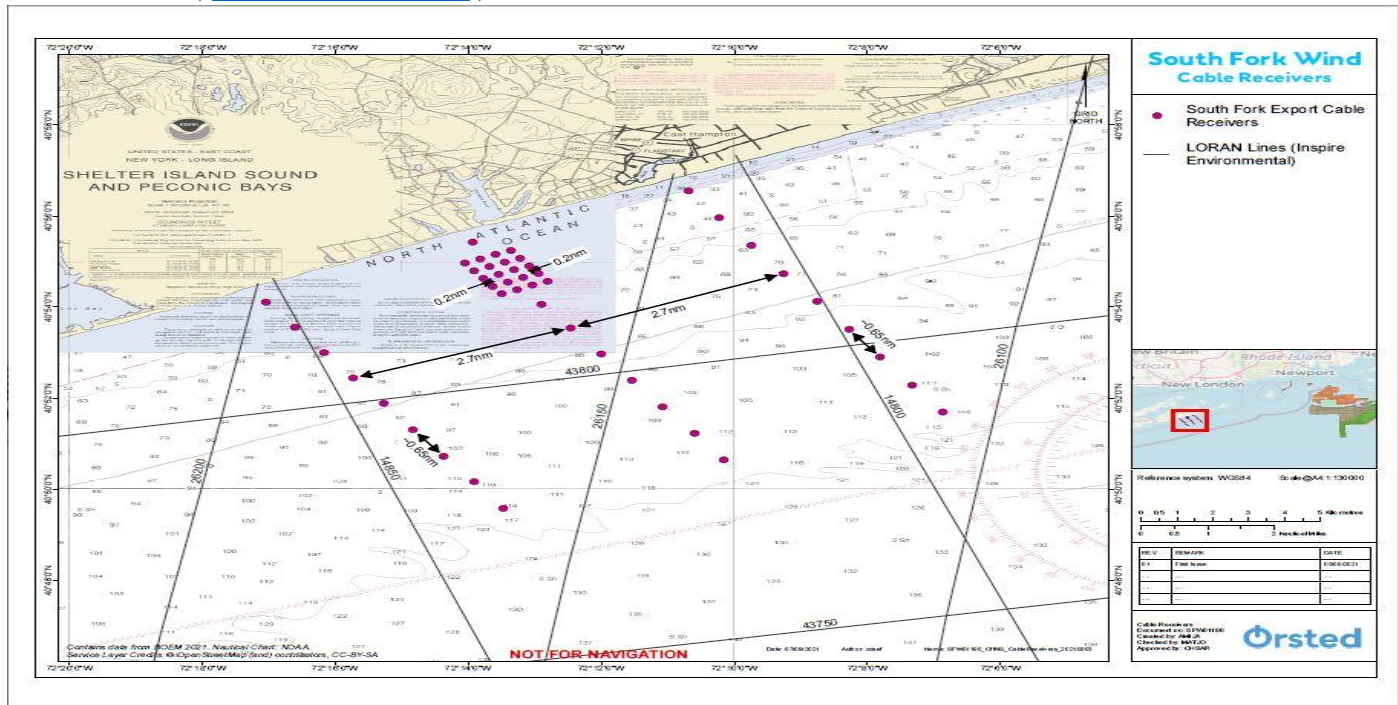

Chart 12300 LNM 02/23

NY-LONG ISLAND OFFSHORE-WAINSCOTT BEACH AREA-Update 11/03/2022

ORSTED will be deployed for an indefinite time in an area bounded on the east by moorings located at 40° 56' 33.0612"N, 72° 10' 40.9188"W (inshore) and 40° 51' 41.5188"N, 72° 6' 52.6212"W (offshore) and on the west by moorings located at 40° 54' 6.3612"N, 72° 17' 2.8788"W (inshore) and 40° 49' 34.5"N, 72° 13' 27.9588"W (offshore). Concerns and for more information, see South Fork Wind below or contact Orsted Northeast Marine Affairs Manager, John Mansolillo, JOMAN@orsted.com , 401-450-5467.



LNM 37/21

MA-NANTUCKET SOUND-Updated 10/29/2022

On or about the 30th of October in preparation for Cable Laying Operations there will be a construction barge and a materials barge along with tugs KODIAK and BUCKY performing Diving Operations at the HDD Cable ducts to get the cables ready for connection and pull-in to the beach. Additionally, six smaller workboats and a Crew Transfer Vessel will assist in these operations. Subsequently, the Cable Barge ULISSE will be towed to site by the NICOLE FOSS and begin conducting cable laying operations approximately 700m (0.4nm) off Covell’s Beach, Barnstable. The cable will be pulled to shore by an onshore winch, once secured the ULISSE will lay and bury the cable away from the beach out to the Cape Poge area. Attending the ULISSE cable laying operations will be the support vessels MENA C & MARTINE P that will be performing anchor handling for the operations. Two local fishing vessels will be operating around the activities as safety vessels to monitor traffic and facilitate the safe movement of fishing vessels, recreational craft, or other transiting vessels, around the work sites and project vessels. All Mariners transiting or fishing in the area are requested to give a wide berth to the vessels as they are limited in their ability to maneuver, and the Cable layer ULISSE will have gear out 1500m ahead of the vessel and up to 1500 meters behind the vessel. The ULISSE will operate on a 5-point mooring spread utilizing the full width of the Offshore Export Cable Corridor (OECC). The mooring spread will consist of four positioning anchors positioned up to 1 km or 0.54 nm from the barge and a single pulling anchor positioned up to 1.5 km or 0.82 nm. Her anchors will be deployed with pennant buoys and will be marshalled by various support vessels. Vessels in the vicinity of the operations are requested to operate in a manner as to not endanger the vessel or associated equipment. Passing arrangement can be made via VHF with the vessels on VHF-FM CH 13 and 16. Additional information on this project can be viewed at the following link: <https://www.vineyardwind.com/mariners-updates/70>



LNM 44/22

ATLANTIC OCEAN-SOUTH FORK WIND

South Fork Wind will install a temporary metocean wave buoy with a single mooring anchor in position 40-55-04.24 N 072-14-04.819 W. The buoy will be set on or about **11/9/2022** and removed on or about **04/30/2023**. The wave buoy will provide real-time sea conditions to inform activities in the area. Work at South Fork Wind's cable landfall area is bounded by positions 40- 55 24.2N 072-14-22.812W, 40-55-43.2114N 072-13-41.844W, 40-55-02.7114N 072-14-5.28W, 40-55-21.9N 072-13-24.312W, approximately 1500 yards off Beach Lane, East Hampton, NY. The jack up vessel Lift Boat JILL, attended by support vessels, to include the Seacor BRAVE and a work skiff, will be on scene from as early as 11/14/22 through 03/31/2023. Boulder clearance vessel Laney Chouest may be in New York state waters during winter 2023. When the Lift Boat JILL departs scene, the pipe installed will have its end temporarily marked with a single, unlit, red A3 sized Cherry Fender in position 40-55-24.74N 072-13-55.73W. Future work in NYS waters will include both removal of the wave buoy and interconnection of the export cable, in 2023. Vessels will be available on VHF FM 16 and 13. Mariners are advised to use caution when transiting the area.

Chart 13303 LNM 44/22

Encl 3

ATLANTIC OCEAN-BETWEEN BARNAGET LIGHT AND ATLANTIC CITY

Fugro will be conducting geotechnical survey operations **between June 1, 2022 to March 31, 2023** 16 miles off the New Jersey coast, between Barnaget Light and Atlantic City, bounded by the following positions:

NE Corner: 39° 40' 22"N / 73° 56' 11"W.

SE Corner: 39° 15' 43"N / 73° 56' 34"W.

S Corner: 39° 08' 40"N / 74° 05' 50"W.

SW Corner: 39° 16' 31"N / 74° 14' 55"W.

NW Corner: 39° 35' 14"N / 74° 02' 59"W.

Equipment on scene will be the Seabed CPR Unit – Fugro Seacalf and Geotechnical Drilling Rig – Fugro C30 and the HOS Browning will be monitoring VHF-FM CH 16 for safe passing arrangements. The HOS Browning will be restricted in her ability to maneuver for extended periods (up to 72 hours) and is requesting mariners operating in or transiting the area to give a 1 nautical mile, closest point of approach. Mariners are advised to use caution and transit at slow speed to minimize wake when transiting the area.

Chart 13003 LNM 44/22

NY-LONG ISLAND-EAST HAMPTON

South Fork Wind intends to install a temporary metocean wave buoy with a single mooring anchor in position 40-55-04.24 N 072-14-04.819 W. The buoy will be set on or about **10/19/2022 and removed on or about 04/30/2023**. The purpose of this wave buoy is to provide real-time sea conditions to inform activities in the area. Work to begin efforts at South Fork Wind's cable landfall area will be conducted in a box bounded by positions:

40- 55 24.2N 072-14-22.812W, 40-55-43.2114N 072-13-41.844W, 40-55-02.7114N 072-14-5.28W, 40-55-21.9N 072-13-24.312W, (see chart below), approximately 1500 yards off Beach Lane, East Hampton, NY. The jack up vessel Lift Boat JILL, attended by support vessels, to include the Seacor BRAVE, will be on scene from as early as 11/14/2022 to as late as 02/28/2023. Vessels will be available on VHF FM 16 and 13. Mariners are advised to use caution when transiting the area.



Encl 3

ATLANTIC OCEAN-COMMONWEALTH WIND-OSC-A 0534

Avangrid Renewables was informed by its contractor that an 11 m length of coiled rod, seismic cone, and 2 sections of casing were lost in the seafloor, in position 40-52-59.905N 070-43-19.333W. The loss occurred on August 23, 2022, while performing routine geotechnical surveys (cone penetration testing) in Lease OCS-A 0534. The available evidence suggests that the marine debris is 0.78 m below the seabed. There are no hazardous materials or oil within the debris. Therefore, the lost gear is not reasonably recoverable and should not interfere with other OCS uses or the environment.

LNM 37/22

Acoustic Monitoring of Highly Migratory Fish Species in RI/MA Wind Energy Areas

The New England Aquarium and INSPIRE Environmental are conducting research on the movements of highly migratory fish species (sharks, tunas, and marlins) in the southern New England wind energy area. Part of this research requires acoustic receivers to be placed on the sea floor in the locations shown as colored circles in the below map. To reduce the risk of entangling protected species, receivers have no surface buoys and are connected to a mooring system weighing approximately 75 pounds that extends 2 to 3 meters (6 to 9 feet) off the sea floor, as shown in the below photo. To reduce risk of interaction with mobile fishing gear, receivers have been placed near obstructions to the extent possible. All receivers will be deployed in these locations until December 15, 2022.

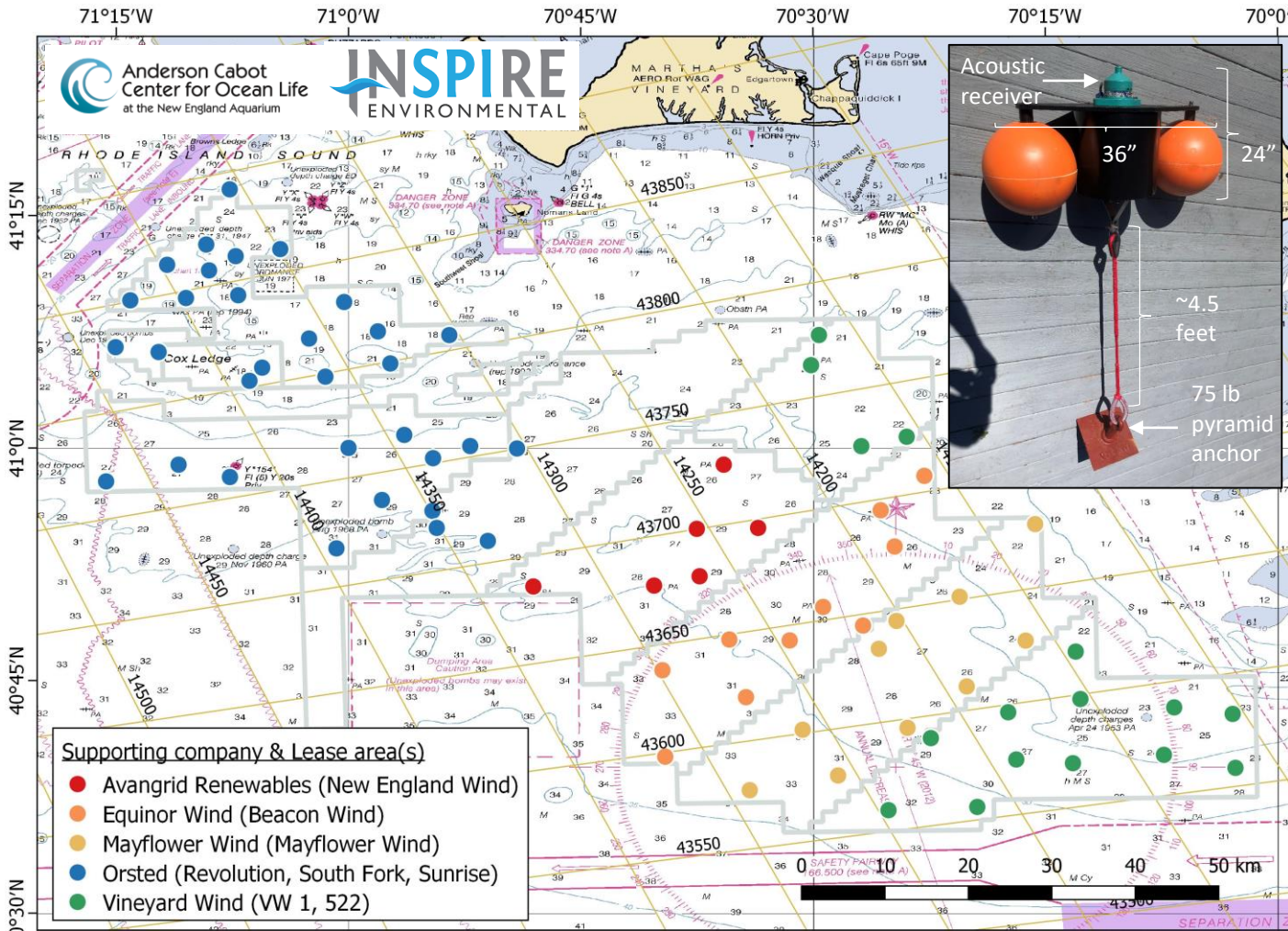

For more information on the research, please contact the New England Aquarium or INSPIRE Environmental. For information on activities in a particular offshore wind lease area, please contact the developer staff listed below.

New England Aquarium

Jeff Kneebone, Senior Scientist
603-969-2138

jkneebone@neaq.org

INSPIRE Environmental

Brian Gervelis, Senior Scientist
401-608-2735

brian@inspireenvironmental.com

Orsted

Christopher Sarro
Marine Affairs Specialist
Fisheries Liaison
857-276-1332
chsar@orsted.com

Mayflower Wind

Joel Southall
Fisheries Liaison Officer
617-817-4682
Joel.Southall@mayflowerwind.com

Vineyard Wind

Crista Bank
Fisheries Liaison
508-525-0421
cbank@vineyardwind.com

Julia Prince
Marine Affairs Specialist
Fisheries Liaison
857-348-3263
julpr@orsted.com

Equinor Wind US
Elizabeth Marchetti
Fisheries Liaison
401-954-2902
emarc@equinor.com

Avangrid Renewables
Caela Howard
Fisheries Liaison
617-999-3882
Caela.howard@avangrid.com

Gear loss claim Instructions

Instructions

To have a claim reviewed, applicants must:

1. Contact Ørsted Offshore North America's Corporate Fisheries Liaison or a Regional Fisheries Liaison as soon as safe and in all instances within 14 days to notify them of incident. Contact information for the Fisheries Liaisons is below.

Corporate Fisheries Liaison
Rodney Avila
rodav@orsted.com
857-332-4479

Mid-Atlantic Fisheries Liaison
Kara Gross
kargr@orsted.com
857-330-7699

NY/CT Fisheries Liaison
Julia Prince
julpr@orsted.com
631-662-3775

RI/MA Fisheries Liaison
Chris Sarro
chsar@orsted.com
857-276-1332

2. Provide responses to each item in the Gear Claim Application Form. Applicants may print the form found here <https://bit.ly/3q1XNo3> and submit the completed form with required documents to Ørsted Offshore North America's Corporate Fisheries Liaison and the appropriate Regional Fisheries Liaison via email.
3. Submit the completed application within 30 days of incident.

Overview of gear loss claim form review process

Claims will be reviewed by Ørsted Offshore North America for completeness. Incomplete submissions will be rejected and applicants will be notified. If an application is rejected for incompleteness, an Applicant may resubmit a complete application within 30 days after receiving an incomplete notice.

Complete applications will be substantively reviewed by the Fisheries Representative for the Applicant's home port, the Ørsted Offshore North America Fisheries Liaison, and a representative of Ørsted Offshore North America. A majority of these three individuals is necessary to approve a claim. Applicants will be notified of Ørsted Offshore North America's findings, in writing, within 30 days of receipt of a complete application.

If a finding is made that the gear loss resulted from an interaction with a vessel or equipment associated with one of Ørsted Offshore North America's projects, Ørsted Offshore North America will notify the Applicant of the amount to be paid and issue a check for that amount within five business days of the expiration of the Notice of Appeal period.

If the claim is denied, a written explanation will be provided to the Applicant.

Applicants who disagree with the decision, or part of a decision, will have an opportunity for an appeal as described below.

Required elements of gear loss claim form

1. The name, mailing address, telephone number, email address, and employment status (i.e. vessel owner, operator/captain, or crew) of each claimant.
2. Coast Guard Documentation Number or State Registration Number of the Vessel
3. Copy of a valid fishing permit
4. Home Port of the Vessel
5. Type of Vessel
6. Size of Vessel
7. Gear type
8. Claim amount
9. A full statement about the damage and/or loss. The statement must include:
 - Date the damage or loss was first discovered
 - If mobile gear, your vessel's direction, speed, and activities immediately before, during, and after the incident (including a full description of both the deployment of any fishing gear which is the subject of the claim and all attempts at retrieval of the gear)
 - Names and addresses of all witnesses to the incident
 - Specific location of incident in LORAN or LAT/LONG
 - If available, a description of the vessel, item, or obstruction which caused the incident and whether or not any surface markers were attached to or near the obstruction
 - Reasoning why the loss and/or damage is associated with Ørsted Offshore North America activities
10. In order to receive compensation for lost or damaged gear, please provide the following:
 - An itemized and complete list of all lost and/or damaged fishing gear
 - Proof of purchase of all lost and/or damaged gear
 - An estimate from a gear repair or supply company to repair or replace lost or damaged gear
 - If you are repairing the gear by yourself, a detailed estimate identifying the repair cost
11. If claiming economic loss, please submit the following:
 - VTRs for the three fishing trips immediately before the trip during which the loss occurred or was discovered
 - VTR for the trip on which the loss occurred or was discovered
 - VTR for the trip immediately following the trip on which the loss occurred or was discovered
 - If mobile gear, a statement describing the amount of time each of the above trips took
 - If fixed gear, a statement on the number of gear units deployed on each trip
 - A statement of the amount of time lost from fishing because of the gear loss and/or damage and a full explanation of why this time period is reasonable
 - Documentation of the date replacement gear was ordered and received or the date gear repair began and ended

If awarded based on a review of the information submitted, economic loss will be paid in the amount of 50 percent of the Applicant's gross income, as estimated by Ørsted Offshore North America, that the Applicant will lose because of not being able to fish, or having to reduce fishing effort, during the period before the Applicant's damaged or lost fishing gear is replaced and available for use. This period begins on the date of the incident and ends on the date the damage could reasonably have been remedied by repair or replacement.

Appeal process

- Within 30 days after the written decision is issued, Applicants who disagree with the decision, or part of a decision, may file a written notice of appeal by sending the notice to Ørsted North America's Corporate Fisheries Liaison and ROSPE@orsted.com. Notice of Appeal forms can be found here <https://bit.ly/35qbs0i>
- All decisions will become final 30 days after the date indicated on the decision. Appeals made after 30 days will not be accepted.
- The notice of appeal must state the reason for the appeal and an explanation as to why the Applicant believes Ørsted Offshore North America's findings are incorrect. Incomplete notices of appeal will not be accepted.
- Ørsted will provide an Independent Third-Party Reviewer (ITR) with the notice of appeal and the applicant's complete application.
- The ITR will, within 30 days, review the issues raised in the notice of appeal and issue a written determination.
- The ITR's decision will be final and not subject to any further right of appeal.

Gear loss claim Application

Name _____ Address _____

Phone number _____ Email _____

Vessel name _____ Home port _____

Gear type _____ State license # _____

Federal permit # _____

Vessel documentation number / registration number # _____

Claim amount _____

Required elements of gear loss claim form

1. A full statement about the damage and/or loss. The statement must include:
 - Date the damage or loss was first discovered
 - If mobile gear, your vessel's direction, speed, and activities immediately before, during, and after the incident (including a full description of both the deployment of any fishing gear which is the subject of the claim and all attempts at retrieval of the gear)
 - Names and addresses of all witnesses to the incident
 - Specific location of incident in LORAN or LAT/LONG
 - If available, a description of the vessel, item, or obstruction which caused the incident and whether or not any surface markers were attached to or near the obstruction
 - Reasoning why the loss and/or damage is associated with Ørsted Offshore North America activities
2. In order to receive compensation for lost or damaged gear, please provide the following:
 - An itemized and complete list of all lost and/or damaged fishing gear
 - Proof of purchase of all lost and/or damaged gear
 - An estimate from a gear repair or supply company to repair or replace lost or damaged gear
 - If you are repairing the gear by yourself, a detailed estimate identifying the repair cost
3. If claiming economic loss, please submit the following:
 - VTRs for the three fishing trips immediately before the trip during which the loss occurred or was discovered
 - VTR for the trip on which the loss occurred or was discovered
 - VTR for the trip immediately following the trip on which the loss occurred or was discovered
 - If mobile gear, a statement describing the amount of time each of the above trips took
 - If fixed gear, a statement on the number of gear units deployed on each trip
 - A statement of the amount of time lost from fishing because of the gear loss and/or damage and a full explanation of why this time period is reasonable
 - Documentation of the date replacement gear was ordered and received or the date gear repair began and ended

By submitting this Application, Applicant authorizes Ørsted Offshore North America Inc. to make whatever reasonable inquiries and investigations it deems necessary to verify the Application and request for compensation. Applicant understands that submitting this Application does not guarantee payment. Applicant further agrees that if the claim is accepted and paid, acceptance of such payment constitutes full, final and complete payment for this particular claim and that neither Ørsted Offshore North America Inc., nor any of its affiliates or joint venture partners shall have any further outstanding or ongoing obligation with respect to this particular claim and Applicant shall not, directly or indirectly, assert any claim, or commence, join in, prosecute, participate in, or fund any part of, any suit or other proceeding of any kind against Ørsted Offshore North America Inc., or any of its affiliates or joint venture partners, based upon this particular claim. If a claim is denied in part, Applicant may accept payment for the undisputed portion, as long as a release for that portion is provided, without waiving Applicant's right to appeal the disputed part of the claim. Applicant recognizes that submission of this Application does not affect Applicant's rights concerning matters other than those specifically identified in this particular Application. Finally, Applicant attests under penalty of perjury that to the best of Applicant's knowledge the information submitted is true and correct.

Signature _____

Date _____

Encl 4

**U.S. Department of
Homeland Security**

**United States
Coast Guard**



LOCAL NOTICE TO MARINERS 02/23

BRIDGE SECTION

BRIDGE DEVIATIONS, REPAIRS AND CONSTRUCTION

BRIDGE/WATERWAY	MILE	33 CFR Sect.	DEVIATION/RULE	EFF. DATE
US 1 Bridge/ Housatonic River	3.5	117.207(a)	Temporary Final Rule	11/30/2022-6/30/2023
Loop Parkway Bridge/Long Creek	0.7	117.799(f)	Temporary Deviation	9/15/2022-5/15/2024
Meadowbrook Parkway Bridge/ Sloop Channel	12.8	117.799(h)	Temporary Deviation	9/15/2022-5/15/2024
Marine Parkway Bridge/Jamaica Bay	3.0	117.795(a)	Temporary Deviation	12/1/2022-5/29/2023
PATH Bridge/Hackensack River	3.0	117.723(b)	Temporary Final Rule	11/14/2022-3/23/2023
Point No Point Bridge/Passaic River	2.6	117.739(c)	Temporary Deviation	12/7/2022-5/19/2023
Raritan Drawbridge/Raritan River	0.5	117.747(a)	Temporary Deviation	11/22/2022-1/20/2023
Gowanus Canal/ Union Street	2.1	117.787	Temporary Deviation	1/13/2023-2/3/2023

MASSACHUSETTS - BOSTON HARBOR – Bridge Repairs – Contractors are installing fiberglass pile jackets on deteriorated timber supports on the Spinnaker Island Bridge through **January 31, 2023**. Work hours are from 6 a.m. to 6 p.m. Monday – Friday. Divers will be on-scene throughout construction. A minimum of 10 spans will be open at all times for transit under the bridge by small boats, canoes and kayaks. Work floats, a support barge, support vessels, and dive operations will block passage through the spans as the work progresses. There will be no reduction in vertical clearance on the open spans. Questions may be directed to Nathan Fontaine, Project Superintendent for ACK Marine & General Contracting at 978-798-8063 or Danielle Goudreau, Collins Engineers at 401-287-8864. Mariners are advised to plan their transits accordingly and exercise caution.

MASSACHUSETTS – BOSTON INNER HARBOR – MYSTIC RIVER – Bridge Repairs – A 13 month bridge repair project will be conducted at the Tobin Bridge, mile 0.1, across the Mystic River between Boston and Chelsea from May 1, 2022, through **June, 2023**. Working hours are from 0600 to 1500 and from 1900 to 0400, Monday through Friday. Work will be conducted outside of the 600 foot navigation channel with the exception of Under Bridge Inspection Units which will reduce the vertical clearance over the 600 foot navigation channel by approximately 10 feet for two to three weeks at the beginning of the project and for two to three weeks at the end of the project. Coast Guard Sector Boston will coordinate with the pilots and SPS New England so the Under Bridge Inspection Units are not operating over the navigation channel during the passage of deep draft vessels. Temporary scaffolding and work platforms will at times be installed around the bridge piers and lighted with constant red lights. Except when barges are relocated, barges will operate outside of the 600 foot channel. The barges will be lit with constant burning white lights on all four corners. Barge operators will monitor VHF channels 13/16. Questions may be directed to Darren Saunders, Project Manager for SPS New England at 508-982-4652; Patrick Blais, Project Superintendent for SPS New England at 978-994-2741 or Tim Chase, Coast Guard Sector Boston at 617-447-1620. Mariners should use caution while transiting the area
Chart 13272 LNM 02/23 (CGD1)

Encl 4

MASSACHUSETTS - BOSTON HARBOR - NEPONSET RIVER – Bridge Repairs - Channel Restrictions for the Granite Avenue Bridge - From January 3 to **April 30, 2023**, from 7 a.m. to 5 p.m. (Monday through Friday) and 7 p.m. to 5 a.m. (Sunday through Thursday) the horizontal clearance will be reduced to 30 feet (MHW). Vertical clearance will be reduced to 5 feet (MHW). Vessels capable of passing through the bridge in the closed position will be allowed to do so. Work vessels will monitor VHF channels 13/16. The draw will be able to open for vessels and the contractor can provide a full horizontal clearance provided at least one hour notice is given by calling Andrew Chamberland, SPS New England, Inc. at 508-328-8828. There will be no clearance restrictions on holidays. Questions may be directed to Tom Mulry, MassDOT, at 617-963-4233 or Noah Chinburg, SPS New England, Inc. at 603-682-6763. Mariners are advised to plan their transits accordingly.
Chart 13270 LNM 02/23 (CGD1)

MASSACHUSETTS – SALEM AND LYNN HARBORS – BELDEN BLY DRAWBRIDGE – Channel Restrictions
Mariners are advised that MassDOT has commenced construction of the new Belden Bly (Route 107) Drawbridge over the Saugus River. From January 23 through **February 4, 2023**, barges will conduct dredging in the navigation channel from 6 a.m. to 7 p.m. daily. The barges will move for transiting vessels upon request via VHF radio channels 13/16 and will be moored outside of the channel after working hours. From January 16 through **January 23, 2023**, there will be a full channel closure to allow the installation of submarine cables. A 100 yard Safety Zone will be in effect for the duration of the full channel closure. Vessels will not be able to pass through the bridge site during this period without permission from the Sector Boston COTP. Questions may be directed to William Schurman, SPS New England at 978-265-7263, Peter Tramontozzi, MassDOT Highway Division at 617-279-9022 or Brian Zilinsky MassDOT at 617-223-1596. Mariners are urged plan accordingly for the channel restrictions and to transit with caution.
Chart 13275 LNM 02/23(CGD1)

MASSACHUSETTS – SALEM AND LYNN HARBORS – GENERAL EDWARDS DRAWBRIDGE – Bridge Closure -
The General Edwards Drawbridge over the Saugus River between Revere and Lynn is closed to vessel traffic due to structural repairs. Vessels able to pass under the bridge in the closed position may do so. Questions may be directed to Christopher Leahy or Elias Demissie, MassDOT Highway Division at 617-892-3643 or 781-570-6051. Mariners are urged to transit with caution.
Chart 13275 LNM 02/23(CGD1)

MASSACHUSETTS – DANVERS RIVER – KERNWOOD AVENUE BRIDGE – Bridge Repairs – The Kernwood Bridge over the Danvers River is opening for marine traffic. Mariners can expect delays due in openings due to ongoing repairs following recent storm events. Mariners are requested to provide two hours advance notice for openings. The navigation lights are under repair and may not be operating properly. The point of contact is Elias Demissie, MassDOT at 781-570-6051 or 617-892-3643, or Mark Rousseau, SPS New England, at 978-992-2842. Mariners are advised to plan transits accordingly.
Chart 13275 LNM 02/23 (CGD1)

MASSACHUSETTS – ANNISQUAM RIVER – BLYNMAN CANAL – Bridge Inspection – Atane Engineers, P.C. will conduct an inspection of the Blynman Drawbridge over the Blynman Canal in Gloucester, Massachusetts on **January 17** and **January 24, 2023**. Work hours are from 7 a.m. to 3 p.m. In case of inclement weather the inspection may be moved to the following day. The inspection will be conducted with a self-propelled work float and scaffolding operating in the navigation channel. The bridge will open for vessels upon request and the work float will move out of the channel to allow the passage of vessels. The work float will monitor VHF Channel 13 and 16 and maintain communications with the bridge tender. Vessels that can pass under the draw without an opening may do so. A safety vessel will be on-scene to assist in coordinating passage. Questions may be directed to Eli Demissie, MassDOT at 781-570-6051 or Peter Keeping, ATANE Engineers, at 617-455- 2295. Mariners are advised to plan accordingly when transiting the area. Mariners are advised to exercise caution.
Chart 13281, LNM 02/23 (CGD1)

MASSACHUSETTS–ANNISQUAM RIVER – MBTA RAILROAD DRAWBRIDGE – Construction of Retaining Wall - The MBTA is constructing a sheet pile retaining wall on the northwest side of the channel. Construction barges will not impede navigation through the bridge and the bridge will operate on its normal schedule. Construction will begin on approximately January 30, 2023. Work hours will fluctuate based on the tides. At night the barges will be moored away from the bridge near the docks of the Gloucester Marina. Questions may be directed to the MBTA Resident Engineer, Matt Moorehouse at (617) 839-8075, or Mr. Tim Chase Sector Boston Waterways Management at (617) 447-1620. Mariners are urged to transit with caution.
Chart 13281 LNM 02/23 (CGD1)

Encl 4

CONNECTICUT – NEW LONDON HARBOR - Bridge Repairs – From April 1, 2022 to **June 25, 2025**, between 7 a.m. and 5:30 p.m., the Connecticut Department of Transportation will conduct repairs on the Gold Star I-95 Northbound Bridge over the Thames River, mile 3.1. Work will be performed from hanging platforms on the bridge structure. The platforms will extend over the river approximately 420 feet from the shoreline on the New London side and 290 feet from the shoreline on the Groton side and will not be over federal channel. The reduction in vertical clearance caused by the platforms will not exceed 3 feet below the current bridge vertical clearances of 135 feet (MHW). A safety boat will be in the water and will monitor VHF Channel 16 when work is performed over the water. Questions may be addressed to Scott Thompson, Project Manager Aetna Bridge Company, at 401-663-6052 or Keith Schoppe, CT DOT, at 860-213-2360 .
Chart 13213 LNM 02/23 (CGD1)

CONNECTICUT – CONNECTICUT RIVER DEEP RIVER TO BODKIN ROCK – CONNECTICUT RIVER – Bridge Closure – The East Haddam Swing Bridge at mile 16.8, across Connecticut River at East Haddam, Connecticut, is closed to vessel traffic due to electrical issues. Vessels able to pass under the bridge in the closed position may do so. Questions may be directed to Matt MacMurray (860) 213 – 2625. Mariners are urged to transit with caution.
Chart 12377 LNM 02/23 (CGD1)

CONNECTICUT – NORTH SHORE OF LONG ISLAND SOUND - HOUSATONIC RIVER AND MILFORD HARBOR – HOUSATONIC RIVER – Bridge Rehabilitation/ Temporary Final Rule – Construction to the Washington Ave (Route 1) Bridge over Housatonic River at mile 3.5 will commence on January 4, 2022. Hours of operation are from Sunday to Saturday between 12:01 a.m. and 10 p.m. A barge and an underbridge inspection unit will be operated under one closed draw span. A minimum of 62.5 feet navigation channel will be free of obstruction at all times. A floating causeway will be installed from the vicinity of the west abutment to pier 3 (outside the navigation channel). This access will be in place for the majority of the project scope providing access to pier 3 and a docking point for the safety and work boats and platforms. This floating causeway will be secured using heavy dock lines and land anchors as needed fixed to the existing piers. Hinged ramps will be utilized to transition from the causeway to land and the pier. From November 30, 2022 to **June 30, 2023** the draw shall operate on single leaf operations. Mariners requiring full horizontal clearance can contact the contractor via marine radio VHF-FM Ch 13/16 or call DOT Resident Engineer Stacey Epps (203) 913-4489. This project is to be completed by **June 30, 2023**. Mariners are advised to exercise caution and reduce wake when transiting the area.
Chart 12370 LNM 02/23 (CGD1)

CONNECTICUT – NORTH SHORE OF LONG ISLAND SOUND - HOUSATONIC RIVER AND MILFORD HARBOR – HOUSATONIC RIVER – Bridge Rehabilitation – Beginning April 1, 2021 until **December 2023** Connecticut Department of Transportation will be performing bridge rehabilitation work at the Bridge Street Bridge across Housatonic River at mile point 13.8. Any questions regarding construction can contact Ms. Heather Falzano at (203) 389-3126. Mariners are advised to exercise caution when transiting the area.
Chart 12370 LNM 02/23 (CGD1)

CONNECTICUT – LONG ISLAND SOUND – NORWALK RIVER – Bridge Repairs – Starting December 7, 2018 ConnDOT will be performing repairs on the Yankee Doodle Bridge over Norwalk River at mile 0.7. A working platform will be installed beneath the bridge deck, which will reduce the navigational vertical clearance from 60 feet to 56 feet at MHW. There will be a 28’x10’ aluminum workboat tied to the fender system during construction hours, Monday through Friday 6:30 a.m. to 2:30 p.m. This work is expected to be completed by **June 20, 2023**. Mariners requiring full horizontal clearance can call Kevin Dorynioski at 860-993-6491, Jerry Mals at 860-982-4294, John Jakobeit at 860-229-4853. Mariners are advised to exercise caution when transiting the area.
Charts 12368 LNM 02/23 (CGD1)

NEW YORK – NORTH SHORE OF LONG ISLAND SOUND GREENWICH POINT TO NEW ROCHELLE – MILL NECK CREEK – Bridge Repairs – The Nassau County Department of Public Works is performing bridge rehabilitation at the Bayville Highway Bridge at mile 0.1, across Mill Neck Creek. During this work the bridge will have a reduced vertical clearance and only open one leaf for transits. Single leaf operations are as follows:

- North Leaf CLOSED: January 4, 2023 through April 25, 2023
- South Leaf CLOSED: April 25, 2023 through **December 12, 2023**

Mariners with any questions or concerns can contact Nassau County Department of Public Works Project Manager Juan Medina at (516) 571-6818. Mariners are advised to exercise caution and reduce wake when transiting the area. Chart 12367 LNM 02/23 (CGD1)

Encl 4

NEW YORK – EAST RIVER NEWTOWN CREEK – DUTCH KILLS – Bridge Closure – The Borden Ave Bridge, mile 1.1, is closed due to vandalism. Vessels able to pass under the bridge in the closed position may do so.

Mariners with questions may contact Keith Burrows at (212) 839-3741, NYCDOT Director of Bridge & Tunnel Operations. Mariners are advised to plan their transits accordingly.

Chart 12338 LNM 02/23 (CGD1)

NEW YORK – LONG ISLAND SOUND – HEMPSTEAD HARBOR TO TALLMAN ISLAND – WESTCHESTER CREEK –

Bridge Replacement – New York City Department of Transportation will be performing work on the fenders at Unionport Bridge across Westchester Creek at mile 1.7. Working hours are from 7 a.m. to 3 p.m. From September 1, 2022 to February 13, 2023 to the south span will be erected. From February 13, 2023 to **July 23, 2023** the north span will be erected. During this time the vertical clearance will be reduced by 14 feet. A minimum of 10ft horizontal clearance will be maintained at all times. Mariners requiring full horizontal clearance can contact Abdi Hedayati at (347) 885-8613 or Rocco Cerami (973) 715-7820 or via marine radio VHF CH 13/16 with one hour advance notice during working hours and six hour advance notice after work hours. Mariners are advised to exercise caution and reduce wake when transiting the area.

Chart 12366 LNM 02/23 (CGD1)

NEW YORK – LONG ISLAND SOUND AND EAST RIVER - HEMPSTEAD HARBOR TO TALLMAN ISLAND - HUTCHINSON RIVER – Bridge Repairs – New York City Department of Transportation will be performing repairs at the Pelham Bay Parkway Bridge across Hutchinson River at mile 0.4 **Wednesday 1/17/2023 into Thursday 1/19/2023 between 11 PM and 5 AM or Friday night as rain day.**

Mariners with any questions may contact Mohsin Rizvi at (212) 839-3698. Mariners are advised to exercise caution and reduce wake when transiting the area.

Chart 12366 LNM 02/23 (CGD1)

NEW YORK – SHINNECOCK BAY TO EAST ROCKAWAY INLET- LONG CREEK - Notice of Temporary Deviation -

The Coast Guard has issued a temporary deviation from the regulation governing the operation of the Loop Parkway Bridge across Long Creek at mile point 0.7. The deviation is needed to perform bridge deck repairs. Under this temporary deviation, the Loop Parkway Bridge may operate under single leaf operations during the following dates:

- Phase 1A (9/15/22 to 1/30/23)
 - Single leaf operations of West leaf/East leaf will be inoperable
- Phase 1B (1/30/23 to 5/15/23)
 - Single leaf operations of East leaf/West leaf will be inoperable
- Phase 2A (9/15/23 to 1/30/24)
 - Single leaf operations of West leaf/East leaf will be inoperable
- Phase 2B (1/30/24 to **5/15/24**)
 - Single leaf operations of East leaf/West leaf will be inoperable

Mariners with any questions or concerns may contact Frank Vazquez (516) 351-9251 or Steve Missing (516) 903-1041. Mariners are advised to exercise caution when transiting the area.

Chart 12352 LNM 02/23 (CGD1)

NEW YORK – HUDSON AND EAST RIVERS – GOVERNORS ISLAND TO 67TH STREET – GOWANUS CANAL–

Temporary Deviation – From January 13, 2023 to **February 3, 2023** during work hours, Monday through Friday 7:00 a.m. to 4:00 p.m. New York City Department of Transportation will be performing bridge repairs at the Union Street Bridge across Gowanus Canal at mile 2.1. During work hours the bridge will be closed to the marine traffic. Mariners with any questions may contact Shaikh Islam at 646-892-1333/347-865-1890. Mariners are advised to exercise caution and reduce wake when transiting the area.

Chart 12352 LNM 02/23 (CGD1)

Encl 4

NEW YORK – SHINNECOCK BAY TO EAST ROCKAWAY INLET- SLOOP CHANNEL - Notice of Temporary Deviation

- The Coast Guard has issued a temporary deviation from the regulation governing the operation of the Meadowbrook Parkway Bridge across Sloop Channel at mile point 12.8. The deviation is needed to perform bridge deck repairs. Under this temporary deviation, the Meadowbrook Parkway Bridge may operate under single leaf operations during the following dates:

- Phase 1A (9/15/22 to 1/30/23)
 - Single leaf operations of North leaves/South leaves will be inoperable
- Phase 1B (1/30/23 to 5/15/23)
 - Single leaf operations of South leaves/North leaves will be inoperable
- Phase 2A (9/15/23 to 1/30/24)
 - Single leaf operations of North leaves/South leaves will be inoperable
- Phase 2B (1/30/24 to **5/15/24**)
 - Single leaf operations of South leaves/North leaves will be inoperable

Mariners with any questions or concerns may contact Frank Vazquez (516) 351-9251 or Steve Missing (516) 903-1041. Mariners are advised to exercise caution when transiting the area.

Chart 12352 LNM 02/23 (CGD1)

NEW YORK – JAMAICA BAY AND ROCKAWAY INLET- JAMAICA BAY - Notice of Temporary Deviation

- The Coast Guard has issued a temporary deviation from the regulation governing the operation of the Marine Parkway Bridge across Jamaica Bay at mile 3.0 to accommodate steel painting. Under this temporary deviation, the Marine Parkway Bridge may stay in the closed position beginning 7:00 a.m. December 1, 2022 through 5:00 p.m. **May 29, 2023**. Questions may be directed to the Marine Parkway Bridge Desk at (718) 692-5501, or Nicolae Popescu, at (917) 577-3734. Mariners that can pass without a bridge opening may do so and are advised to exercise caution when transiting the area.

Chart 12350 LNM 02/23 (CGD1)

NEW YORK – HUDSON RIVER TO WAPPINGER CREEK – HUDSON RIVER – RONDOUT CREEK - Bridge Rehabilitation

– Construction to the Wurts St. Bridge (Old 9W Bridge) Bridge across Rondout Creek at mile 1.3 is in progress. Temporary safe span platforms will be installed under the low steel across the entire span which will reduce vertical clearance by approximately 3 feet. Hot work will be performed at this location. For construction related questions, please contact Jordan Strack at 845-264-5716. This project is to be completed by **October 30, 2023**. Mariners are advised to exercise caution when transiting the area.

Chart 12347 LNM 02/23 (CGD1)

NEW YORK – HUDSON RIVER TO WAPPINGER CREEK – HUDSON RIVER – Bridge Rehabilitation – Construction to the Castleton on Hudson Bridge across Hudson River at mile 135.7 is in progress. Hours of operation are from 7 a.m. and 5 p.m. Temporary safe span platforms will be installed under the tram rail steel (over navigation channel) which will reduce vertical clearance by approximately 6 feet. A minimum of 210 feet east side of navigation channel (between PP24 and PP31) will be cleared of obstruction at all times for safe passage of vessels. In addition, a 25 feet of buffer will be maintained each side of the channel marker. A safety boat will be operated IVO the bridge. Hot work will be performed during construction. Mariners requiring full horizontal clearance can contact the contractor/operator via marine radio VHF-FM CH 13 or call 518-320-6986. For all construction related questions, please contact Tim Mastro at 518-337-7231. This project is to be completed by **June 30, 2023**. Mariners are advised to exercise caution when transiting the area.

Chart 12347 LNM 02/23 (CGD1)

NEW YORK – HUDSON RIVER TO WAPPINGER CREEK – HUDSON RIVER – Deck Replacement – Construction to the Newburg-Beacon Bridge (North Span), mile 62.0 across Hudson River is in progress. A temporary work platform will be installed under the entire length of the bridge. Temporary work platform will reduce the vertical clearance in the navigation channel by approximately 3ft. Welding (hot work) may be performed during working hours. The resident engineer or contractor will be equipped with a VHF-FM marine radio and will be monitoring Channel 13/16 during hours of operation. Please contact Mike Lloyd at 914-403-2653 for construction information. This project is to be completed by **June 30, 2023**. Mariners are advised to exercise caution when transiting the area.

Chart 12343 LNM 02/23 (CGD1)

Encl 4

NEW YORK – NEW YORK TO WAPPINGER CREEK - HUDSON RIVER – Main Cable Rehabilitation and Sidewalk Modification – Construction to the main cable rehabilitation and sidewalk modification at the George Washington Bridge across the Hudson River at mile 11.0 is in progress. There will not be any obstruction in the Channel. Welding (hot work) may be performed during working hours. The resident engineer or contractor will be equipped with a VHF-FM marine radio and will be monitoring Channel 13/16 during hours of operation. Mariners can contact Marc Helman at 212-435-6112 for construction details. This project is to be completed by **February 15, 2026**. Mariners are advised to exercise extreme caution when transiting the area.
Chart 12343 LNM 02/23 (CGD1)

NEW YORK – NEW YORK TO WAPPINGER CREEK - HUDSON RIVER – Lower Level Structural Steel Priority Repairs – Construction to the the George Washington Bridge across the Hudson River at mile 11.0 will commence on June 1, 2022. Five localized temporary work platforms will be installed under the bridge and will not reduce vertical clearance in the navigation channel more than 3’-9”. Welding (hot work) may be performed during working hours. The resident engineer or contractor will be equipped with a VHF-FM marine radio and will be monitoring Channel 13/16 during hours of operation. Mariners can contact Marc Helman at 212-435-6112 for construction details. This project is to be completed by **December 31, 2024**. Mariners are advised to exercise extreme caution when transiting the area.
Chart 12343 LNM 02/23 (CGD1)

NEW YORK – TALLMAN ISLAND TO QUEENSBORO BRIDGE – BRONX RIVER – Emergency Bridge Repairs – Repairs to the Bruckner Expressway (Eastern Blvd) Bridge across Bronx River at mile 1.1 is in progress. A work barge will be operating in the navigable channel between 11 p.m. and 5 a.m. Mariners requiring full horizontal clearance can call Terry DeMeo at 347-558-0218. This project is to be completed by January 31, 2023. Mariners are advised to exercise caution when transiting the area.
Chart 12339 LNM 02/23 (CGD1)

NEW YORK – TALLMAN ISLAND TO QUEENSBORO BRIDGE – FLUSHING CREEK -Bridge Repairs – Starting May 5, 2022 until **July 21, 2023**, NYCDOT will be replacing the fenders at the Northern Blvd Bridge across Flushing Creek at mile 0.4. The contractor will be working Monday through Friday in 8-12 hour shifts depending on the tide beginning at 6:00 a.m. and ending at 5:00 p.m. To perform this work the contractor will utilize the following equipment depending on the construction schedule:

- 50’x140’ Flexi-float Barge
- JTC 35200A Hopper Barge
- 4EA 10’x20’ Shughart Pontoons
- F24- Skippy 250hp Single Screw Outboard Pushboat x 24’
- 30’x60’ Flexi-float Barge
- 30’x120’ Material Barge

Mariners with questions or concerns may contact VHF Ch 13, Kevin Azevedo at (917) 575-3884. Mariners are advised to exercise caution when transiting the area.
Charts 12339 LNM 02/23 (CGD1)

NEW YORK – LONG ISLAND SOUND AND EAST RIVER – HEMPSTEAD HARBOR TO TALLMAN ISLAND – EAST RIVER – Deck Replacement – Construction to the Throgs Neck Bridge across East River at mile 15.8 is in progress. Temporary work platform will be installed under the main span over navigation channel. The temporary work platform will reduce the vertical clearance by 4ft 6in max. (Including deflection) from the low steel of the bridge. Hot work operations will be performed at various locations. A barge and safety boat will be operating IVO the bridge. Any questions regarding construction can contact Jeff Brugge via marine radio VHF-FM Ch. 13/16 or 516-445-3495. This project is to be completed by **June 30, 2023**. Mariners are advised to exercise caution when transiting the area.
Chart 12335 LNM 02/23 (CGD1)

NEW YORK – LONG ISLAND SOUND AND EAST RIVER – HEMPSTEAD HARBOR TO TALLMAN ISLAND – EAST RIVER – Rehabilitation Approach Spans – Construction to the Throgs Neck Bridge across East River at mile 15.8 is in progress. Temporary work platform will be installed under the Bronx and Queens approach spans. The temporary work platform will reduce the vertical clearance by 3ft max. (Including deflection) from the low steel of the bridge. Any questions regarding construction can contact Herbert Negron via marine radio VHF-FM Ch. 13/16 or 718-904-4364. This project is to be completed by **August 31, 2023**. Mariners are advised to exercise caution when transiting the area.
Chart 12335 LNM 02/23 (CGD1)

Encl 4

NEW YORK – LONG ISLAND SOUND AND EAST RIVER – HEMPSTEAD HARBOR TO TALLMAN ISLAND – EAST RIVER – Bridge Painting – Painting to the Bronx Whitestone Bridge over East River at mile 13.8 will commence on May 9, 2022. Hours of operation are from 7 a.m. to 3 p.m. and from 11 p.m. to 5 a.m. A 40ft temporary work platform and traveler will be operating under the main span and will reduce vertical clearance by approximately 5ft. A safety will be operating IVO the bridge. Mariners requiring full vertical clearance can contact the contractor via marine radio VHF-FM Ch. 13/16 or call Resident Engineer Robert Leo at 646-201-2451 with one hour in advance notice. This project is to be completed by **September 30, 2024**. Mariners are advised to exercise caution when transiting the area.
Chart 12335 LNM 02/23 (CGD1)

NEW YORK – LONG ISLAND SOUND AND EAST RIVER – HEMPSTEAD HARBOR TO TALLMAN ISLAND – EAST RIVER – Misc. Bridge Repairs and Painting – Repairs and painting to the Bronx Whitestone Bridge over East River at mile 13.8 is in progress. Hours of operation are from 7 a.m. to 3 p.m. and from 11 p.m. to 5 a.m. A 40ft temporary work platform and traveler will be operating under the main span and will reduce vertical clearance by approximately 5ft. A safety will be operating IVO the bridge. Mariners requiring full vertical clearance can contact the contractor via marine radio VHF-FM Ch. 13/16 or call Resident Engineer Robert Leo at 646-201-2451 with one hour in advance notice. This project is to be completed by **September 24, 2024**. Mariners are advised to exercise caution when transiting the area.
Chart 12335 LNM 02/23 (CGD1)

NEW YORK – LONG ISLAND SOUND AND EAST RIVER – HEMPSTEAD HARBOR TO TALLMAN ISLAND – EAST RIVER – Bridge Preservation – From August 13, 2021 to **February 26, 2024**, between 7 a.m. and 3:30 p.m., a bridge traveler will be operated under the Bronx Whitestone Bridge over East River at mile 13.8 to perform maintenance inspection. Mariners requiring full vertical clearance can contact the contractor via marine radio VHF-FM Ch. 13/16 or call Resident Engineer Robert Leo at 646-201-2451. The traveler platform will be moved out of the navigable channel after work hours or when not in use. Mariners are advised to exercise caution when transiting the area.
Chart 12335 LNM 02/23 (CGD1)

NEW YORK – TALLMAN ISLAND TO QUEENSBORO BRIDGE – EAST RIVER – Replacement of Upper Roadways – Construction to the Queensboro Bridge over East River at mile 5.5 is in progress. All work are on top of the bridge. Hot work operations will be performed through **April 27, 2024**. A safety boat will be operating IVO the bridge. Any questions regarding the construction please contact Anthony Grosso at 718-685-3990 or 347-242-6442. This project is to be completed by **April 27, 2024**. Mariners are advised to exercise caution when transiting the area.
Chart 12339 LNM 02/23 (CGD1)

NEW YORK – HUDSON AND EAST RIVERS – GOVERNORS ISLAND TO 67TH STREET - EAST RIVER – Bridge Maintenance – On **January 18, 2023 and January 19, 2023**, between 9:30 a.m. and 2 p.m., a bridge traveler will be operated under the Williamsburg Bridge over East River at mile 2.3 to perform bridge maintenance. Mariners requiring full vertical clearance can contact the contractor via marine radio VHF-FM Ch. 13/16 or call 917-295-1856 or 917-471-2257. The traveler platform will be moved out of the navigable channel after work hours or when not in use. Mariners are advised to exercise caution when transiting the area.
Chart 12335 LNM 02/23 (CGD1)

NEW YORK – HUDSON AND EAST RIVERS – GOVERNORS ISLAND TO 67TH STREET - EAST RIVER – Bridge Maintenance – On **January 12, 2023 and January 17, 2023**, between 9:30 a.m. and 2 p.m., a bridge traveler will be operated under the Manhattan Bridge over East River at mile 1.1 to perform bridge maintenance. Mariners requiring full vertical clearance can contact the contractor via marine radio VHF-FM Ch. 13/16 or call 917-295-1856 or 917-471-2257. The traveler platform will be moved out of the navigable channel after work hours or when not in use. Mariners are advised to exercise caution when transiting the area.
Chart 12335 LNM 02/23 (CGD1)

Encl 4

NEW YORK – HUDSON AND EAST RIVERS – GOVERNORS ISLAND TO 67TH STREET – EAST RIVER – Bridge Rehabilitation – Construction to the Brooklyn Bridge over East River at mile 0.8 is in progress. Hours of operations are from 6 a.m. to 4 p.m. No construction equipment will be operating in the navigation channel during rehabilitation. Mariners can contact Bill Ferdinandsen Resident Engineer at 347-242-6203 for construction status. This project is to be completed by **February 28, 2023**. Mariners are advised to exercise caution and reduce wake when transiting the area.
Chart 12335 LNM 02/23 (CGD1)

a.

NEW YORK – NEW YORK HARBOR – EAST RIVER - HARLEM RIVER – Temporary and Permanent Submarine Cables Installation – Installation of temporary and permanent submarine cables to the Spuyten Duyvil Bridge over Harlem River at mile 7.9 will commence on September 19, 2022. Hours of operations are from 6 a.m. to 4 p.m. There will be waterborne equipment blocking one draw of a swing bridge at a time and the other draw will be free and clear of any equipment for the passage of vessels. Currently there's a approx. 4ft horizontal clearance reduction in the south channel due to cable duct along the fender. This duct will be removed once the permanent cable is installed. Any questions regarding barge placement can contact Weeks Marine at 973-567-5643. This project is to be completed by **May 31, 2023**. Mariners are advised to use north channel, reduce wake and exercise caution when transiting the area.
Chart 12342 LNM 02/23 (CGD1)

NEW YORK – NEW YORK HARBOR – EAST RIVER - HARLEM RIVER – Emergency Bridge Closure – Broadway Bridge, mile 6.8, over across Harlem River was not able to open for marine traffic due to damaged electrical control system. New York City DOT is working diligently to repair the bridge. The bridge will be unable to open to marine traffic until repairs are completed. The vertical clearance in the closed position is approx. 24 feet at MHW. Vessels that can transit under the closed span may do so at any time. Mariners have questions regarding bridge operation information can contact Dennis Biegel at 646-689-6110. Mariners are advised to plan accordingly and exercise extreme caution when transiting the area.
Chart 12342 LNM 02/23 (CGD1)

NEW YORK – NEW YORK HARBOR – EAST RIVER - HARLEM RIVER - Bridge Rehabilitation – Construction to the Broadway Bridge across Harlem River at mile 6.8 is in progress. A temporary shielding is installed under the Broadway Bridge. Temporary shielding will reduce vertical clearance in the navigation channel by approximately 3ft 9in. A one half of navigation channel will be free of obstruction at all time. Mariners have questions regarding temporary shielding information can contact Joe Pollack via marine radio VHF-FM CH 13/16 or 917-656-6820. This project is to be completed by **April 30, 2023**. Mariners are advised to reduce wake and exercise caution when transiting the area.
Chart 12342 LNM 02/23 (CGD1)

NEW YORK – NEW YORK HARBOR – EAST RIVER - HARLEM RIVER – Underwater Inspection – From January 9, 2023 to **January 20, 2023** between 8:00 a.m. and 4:00 p.m., an underwater bridge inspection will be performed at the I-87 NB Ramp (near Macombs Dam) Bridge over Harlem River at mile 3.2. A 21ft dive boat will be operating IVO the bridge. Mariners requiring full horizontal clearance can contact the contractor via marine radio VHF-FM Ch 13/16 or call Clay Carlson (203) 216-1766. Mariners are advised to exercise caution and reduce wake when transiting the area.
Chart 12342 LNM 02/23 (CGD1)

b. **NEW YORK - NEW YORK HARBOR – EAST RIVER - HARLEM RIVER – Electrical/Mechanical Rehabilitation** – Construction to the Madison Ave Bridge across Harlem River at mile 2.3 is in progress. Any questions to this project can contact Kambiz Riazi at 646-246-6666 or Steve Koch at 908-723-4355. This project is to be completed by **August 31, 2023**. Mariners are advised to exercise caution when transiting the area.
Chart 12342 LNM 02/23 (CGD1)

NEW YORK – NEW YORK HARBOR - EAST RIVER – HARLEM RIVER – Emergency Repairs – Emergency repairs to the Third Ave Bridge over Harlem River at mile 1.9 will commence on August 31, 2022. A 50ft by 138ft crane barge will be operating in the east channel (Bronx side) and the west channel will be free of obstruction at all times. Mariners requiring full horizontal clearance in the east channel can contact Tim Gallgher at 908-413-7618 or via marine radio VHF-FM Ch 13/16 with 3 hours advance notice. This project is to be completed by **March 31, 2023**. Mariners are advised to use west channel and reduce wake when transiting the area.
Chart 12342 LNM 02/23 (CGD1)

Encl 4

NEW YORK – NEW YORK HARBOR – EAST RIVER - HARLEM RIVER – Fender Replacement – Construction to the 125th Street (RFK) Bridge across Harlem River at mile 1.3 will commence on October 1, 2022. Hours of operation are from 7 a.m. to 5 p.m. Two 180ft (crane and material) barges, a 150' x 37' hopper barge and 2 flexi float barges will be operating IVO bridge fender system . A minimum of unobstructed 100ft clear channel in the navigation channel will be available at all times. Mariners requiring full horizontal clearance can contact Peter Danyluk at 914-469-1909 (pdanyluk@walsh.com) or via marine radio VHF-FM CH 13/16 with 24 hour advance notice. This project is to be completed by **May 19, 2023**. Mariners are advised to reduce wake and exercise caution when transiting the area.

Chart 12342 LNM 02/23 (CGD1)

NEW YORK – NEW YORK HARBOR – Structural Steel Repairs and Painting – Repairs to the Verrazano Narrows Bridge over New York Harbor are completed. Contractors are removing temporary safe-span platforms but all the main and supporting cables will be remaining at the same locations (where the platform used to be) through **February 28, 2023**. Underbridge Inspection Unit will be used to remove the supporting cables. Mariners required full vertical clearance or any questions regarding platforms/hanging cables please contact Chris Daskalakis at 718-639-5880/Illya Gologorskiy at 917 834-9162 or CG VTS-NY at 718-354-4088. Mariners are advised to exercise caution when transiting the area.

Chart 12327 LNM 02/23 (CGD1)

NEW YORK AND NEW JERSEY – NEW YORK HARBOR – ARTHUR KILL – Bridge Inspection – Inspection to the Goethals Bridge across the Arthur Kill, mile 11.5 will commence on November 1, 2022. Hours of operations are from 7 a.m. to 4 p.m. At times, an underdeck traveler will be operating at various locations over the navigation channel. Mariners requiring full vertical clearance can contact Carlo Thompson via marine radio VHF-FM Ch. 13/16 or call 848-231-3359. This inspection is to be completed by **February 28, 2023**. Mariners are advised to exercise caution when transiting the area.

Chart 12327 LNM 02/23 (CGD1)

NEW YORK AND NEW JERSEY – NEW YORK HARBOR – ARTHUR KILL – Bridge Interim Rehabilitation Priority Repairs – Construction to the Outerbridge Crossing Bridge across the Arthur Kill, mile 2.0 will commence on June 1, 2022. A localized temporary work platform will be installed under the bridge and will not reduce vertical clearance in the navigation channel more than 3'-9". Welding (hot work) may be performed during working hours. The resident engineer or contractor will be equipped with a VHF-FM marine radio and will be monitoring Channel 13/16 during hours of operation. Mariners can contact Marc Helman at 212-435-6112 for construction details. This project is to be completed by **December 31, 2024**. Mariners are advised to exercise extreme caution when transiting the area.

Chart 12327 LNM 02/23 (CGD1)

NEW YORK AND NEW JERSEY – NEW YORK HARBOR – NEWARK BAY – Structural Steel Repairs – Construction to the New Jersey Turnpike Newark Bay (I-78) Bridge, across Newark Bay at mile 4.0 is in progress. Safe span platforms will be installed under the main spans and will reduce vertical clearance by 5 feet. POC for this project is William Ritter and can be reached at 973-390-7221. This project is to be completed by **March 30, 2023**. Mariners are advised to exercise caution when transiting the area.

Chart 12327 LNM 02/23 (CGD1)

NEW JERSEY – PASSAIC RIVER AND HACKENSACK RIVER – HACKENSACK RIVER - Notice of Temporary Final Rule – The Coast Guard is temporarily modifying the operating schedule that governs the PATH Bridge across Hackensack River at mile 3.0 for failure of control system. Under this temporary final rule from November 14, 2022 to **March 23, 2023**, the PATH Bridge shall open on signal provided a minimum of twenty-four (24) hours advance notice by calling US Coast Guard VTS at 718-354-4088 or Port Authority Trans-Hudson John Burkhard at 201-410-4260. The draw need not open for the passage of vessel traffic Monday through Friday from 6 a.m. and 10 a.m., and from 3 p.m. to 7:00 p.m. The vertical clearance in the closed position is approx. 40 feet at MHW. Vessels that can pass under the closed span without a bridge opening may do so at all times. Mariners are advised to plan their transits accordingly and exercise extreme caution when transiting the area.

Chart 12337 LNM 02/23 (CGD1)

Encl 4

NEW JERSEY – PASSAIC RIVER AND HACKENSACK RIVER – HACKENSACK RIVER - New Bridge Construction –

Replacement of the new Witt Penn (Route 7) Bridge across the Hackensack River at mile 3.1 is in progress. Contractors are working on the punch list. There is no barge equipment in the navigation channel. All equipments are placed behind the fender system.

Mariners can contact the personnel below regarding the project:

Alexander Garcia 646-431-2185

Vicken Bedian 347-680-5191

Jerry Yang 201-985-6937

Evan Raab 201-359-0906

This project is to be completed by **February 28, 2023**. Mariners are advised to exercise extreme caution when transiting the area.

Chart 12337 LNM 02/23 (CGD1)

NEW JERSEY – PASSAIC RIVER AND HACKENSACK RIVER – HACKENSACK RIVER – Emergency Repairs –

The Amtrak Portal Bridge at mile 5.0 across the Hackensack River between Kearny and Secaucus, New Jersey is undergoing emergency repairs. While under the repair, the north channel will remain closed to marine traffic. There will be debris scow barge, work boat and push boat blocking the north channel. The south channel is open to marine traffic. Repairs to the north span of the bridge will be ongoing until **March 31, 2023**. Mariners are advised to use south channel when transiting the area and exercise extreme caution. Questions concerning the repairs and closure may be directed to Thomas Bruno at 215-983-9941.

Chart 12337 LNM 02/23 (CGD1)

NEW JERSEY – PASSAIC RIVER AND HACKENSACK RIVER – HACKENSACK RIVER – Bridge Replacement –

Installation of temporary trestle and cofferdam, and testing borings to the Portal Bridge North, across Hackensack River at mile 5.04 is in progress. Hours of operations are from 6:30 a.m. to 4:30 p.m. daily. There will be barge equipments operating outside the navigation channel. Mariners can contact one of the three (3) provided telephone numbers/emails or via marine radio VHF-FM CH 13/16 advising of travel through the channel (including possible return trips):

1. Ernest Hamilton – Main Span Superintendent – (904) 451-2979, ehamilton@traylor.com
2. Martir Ortez – Main Span Project Manager – (562) 307-4916, mortez@traylor.com
3. Jim Hummel – Main Span Area Lead - (917) 417-4885, Jim.Hummel@skanska.com

Skanska Traylor PNB JV has been awarded the construction of the New Portal North Bridge Project (NJT Contract No. 20-083X, WBS No. GC.02) with a Notice to Proceed of April 7, 2022. Specific to the Hackensack River work, mile 5.0, the project consists of constructing two bridge piers, demolition of the existing center pier north fender, erecting three tied-arch spans of approximately 400 LF (1,200 LF overall), and demolition of the existing bridge once railroad traffic is switched to the new bridge.

The current barges are in place as shown below:

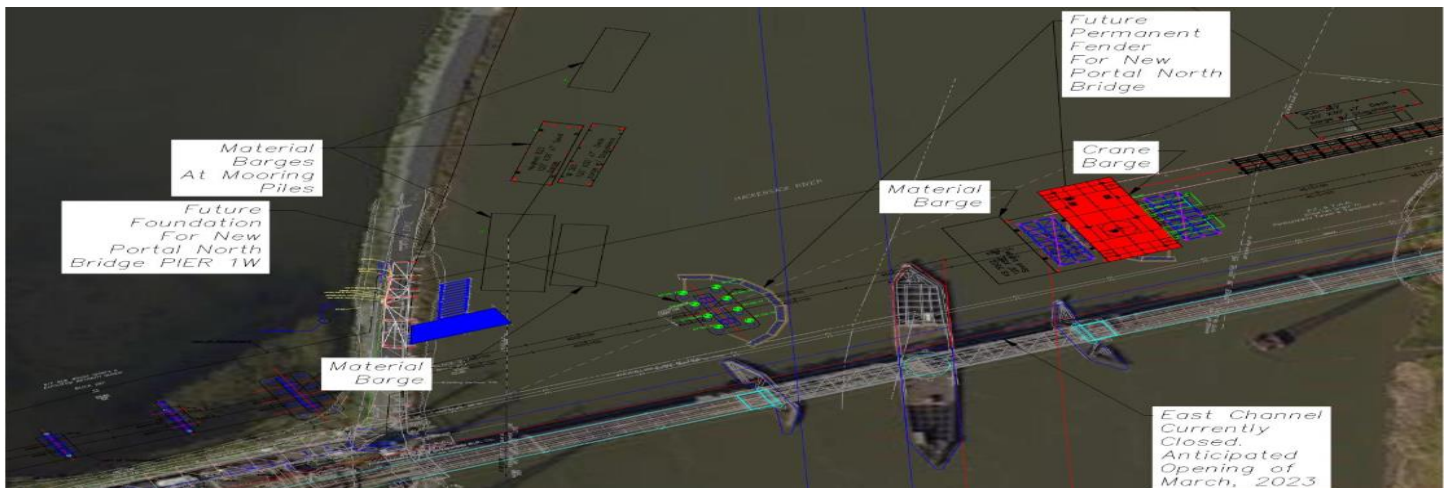

Trestle construction will continue on the East side. This project will be completed by **October 22, 2027**. Mariners are advised to exercise caution when transiting the area.

Chart 12337 LNM 02/23 (CGD1)

Encl 4

NEW JERSEY – PASSAIC RIVER AND HACKENSACK RIVER – PASSAIC RIVER – Bridge Replacement – Installation of temporary trestle, test borings and partial fender removal to the Point No Point Bridge, across Passaic River at mile 2.6 is in progress. Hours of operations are from 6:30 a.m. to 4:30 p.m. daily. Construction equipment will be blocking one channel and the other channel will be open for vessel traffic.

On or about **12/7/22** we will be starting the installation of drilled shafts at Pier 2 (8 EA) & Pier 3 (6 EA) of the new bridge. These piers are located adjacent to the existing swing pier and in the center of the navigation channel. Please refer to the attached. Our barges will be positioned in the channel and blocking one side of the existing channel. Signage will be posted showing which side of the channel is open/closed. While we are installing the shafts, there will be intermittent periods (2-3 days for each shaft) in which drilling will be performed and we will not be able to accommodate a bridge opening. Our equipment will be in the swing path of the bridge; therefore, the bridge cannot open. One side of the existing channel will still be open for travel, but it will be with a Height Restriction. We anticipate the drilled shaft work taking **approximately 14 weeks** to complete, but there will be several days between each shaft installation when the bridge can open. During this time, we request that any known bridge opening needs be communicated with us well in advance so that we can coordinate our drilling operations and relocate our barges as needed. If possible, we'd appreciate at least 7 days notice so we can make the appropriate schedule adjustments. If you do not require a bridge opening, we ask that you please exercise extreme caution while proceeding through our work area. Anticipated Completion of Drilled Shaft Work is on or about **3/6/23**.

Upon completion of the drilled shaft installation, we will be looking to begin the construction of the Pier #3 Pier Cap. This will require the installation of a cofferdam system. During certain phases of the cofferdam construction the bridge will be unable to open. Our anticipated installation start date is **3/13/23**. We anticipate a period of **approximately 8-10 weeks** in which there can be no bridge openings. One side of the existing channel opening will remain in open for travel, but with limited height restriction during this period. Once the cofferdam is in place bridge openings can resume as normal with advanced notice. Anticipated completion of cofferdam installation is on or about **5/15/23**.

RFT554RT4RZ

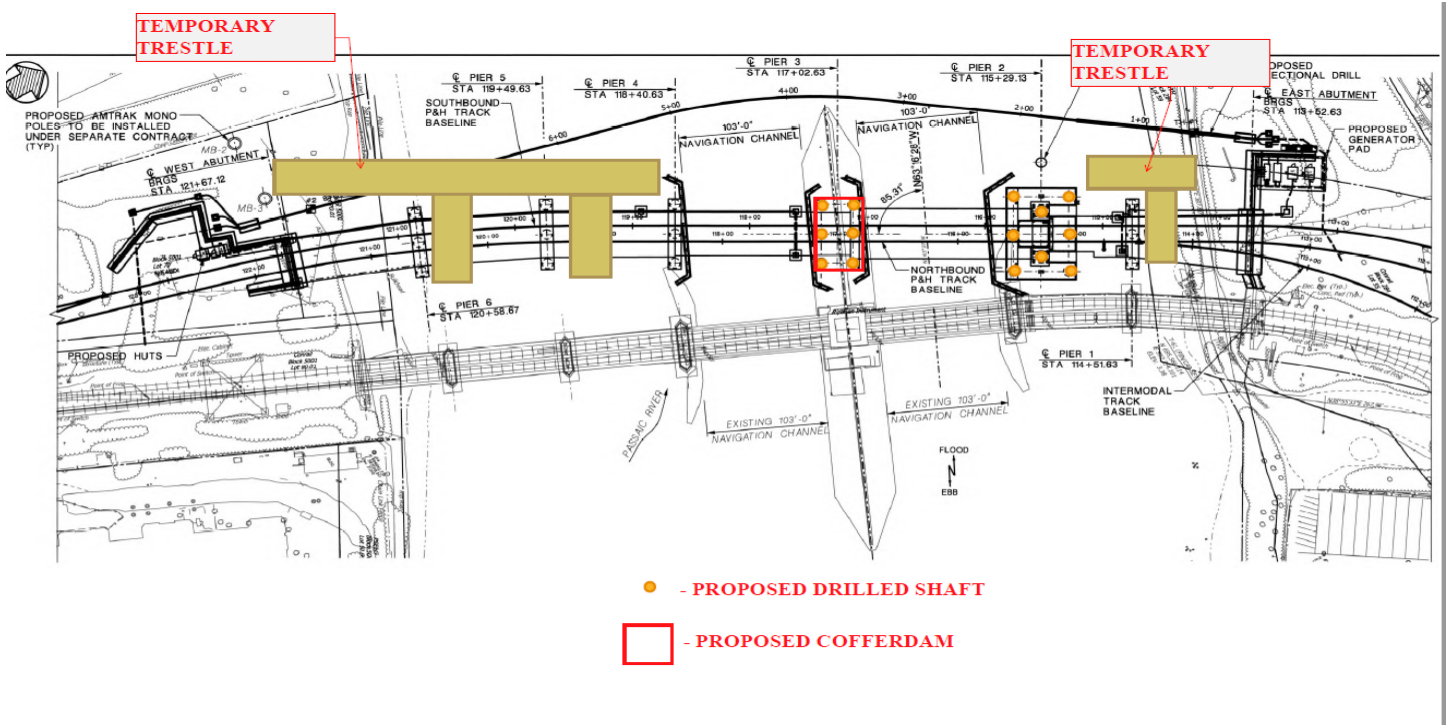

For barge placement details please contact Dan Post at 732-751-209. This project will be completed by **August 13, 2025**. Mariners are advised to exercise caution when transiting the area and plan accordingly. Chart 12337 LNM 02/23 (CGD1)

Encl 4

NEW JERSEY – PASSAIC RIVER AND HACKENSACK RIVER – PASSAIC RIVER – Notice of Temporary Deviation - The Coast Guard is temporarily modifying the operating schedule that governs the existing Point No Point Bridge, mile 2.6, across Passaic River. Under this temporary deviation, the Point No Point Bridge will operate as follows:

From December 7, 2022 to March 8, 2023 the bridge shall open on signal provided a minimum of seven days advance notice by calling Conrail Movement Desk 856-231-2282 or George Harms Construction at 732-751-2091.

From March 13, 2023 to **May 19, 2023** the bridge need not open for the passage of vessel traffic.

Mariners may contact VTS New York at (718) 354-4088 to obtain current information regarding the bridge's operating schedule. The vertical clearance in the closed position is approx. 16 feet at MHW. Vessels that can transit under the closed span may do so at any time. Mariners are advised to plan accordingly and exercise extreme caution when transiting the area.

Chart 12337 LNM 02/23 (CGD1)

NEW JERSEY – PASSAIC RIVER AND HACKENSACK RIVER – PASSAIC RIVER – Emergency Bridge Closure – Dock Bridge, mile 5.0, across Passaic River was not able to open for marine traffic due to mechanical issues. Amtrak is working diligently to repair the bridge. The bridge will be unable to open to marine traffic until repairs are completed. The vertical clearance in the closed position is approx. 24 feet at MHW. Vessels that can transit under the closed span may do so at any time. Mariners have questions regarding bridge operation information can contact Juan Salinas at 267-608-8262. Mariners are advised to exercise extreme caution when transiting the area.

Chart 12337 LNM 02/23 (CGD1)

NEW JERSEY – PASSAIC RIVER AND HACKENSACK RIVER – PASSAIC RIVER – Priority Repairs – Repairs to the Clay Street Bridge, mile 6.0, Bridge Street Bridge, mile 5.6 and Jackson Street Bridge, mile 4.6, all across Passaic River between Essex and Hudson Counties, New Jersey will commence on July 1, 2022. Hours of operation are Monday to Friday, between 7 a.m. and 3:30 p.m. A 14ft by 40ft barge and 21ft push boat will be blocking one channel and the other channel will be open for vessel traffic. For barge placement details please contact Brian Fagersten at 973-390-6872 or via marine radio VHF-FM CH 13/16. This project is to be completed by **September 30, 2023**. Mariners are advised to exercise caution when transiting the area.

Chart 12337 LNM 02/23 (CGD1)

NEW JERSEY – KILL VAN KULL AND NORTHERN PART OF ARTHUR KILL – RAHWAY RIVER – Bridge Repairs and Resurfacing – Construction to the New Jersey Turnpike Bridge over Rahway River at mile 2.0 will commence on June 30, 2022. There will be sectional safe span platforms approx. 6ft 3in wide installed under the span. The safe span platforms will not reduce vertical clearance more than five feet. No equipment in the navigation channel. Any questions regarding this project can contact resident engineer Mike Lettieri at 732-306-9850. This project is to be completed by **January 13, 2023**. Mariners are advised to exercise caution when transiting the area.

Chart 12333 LNM 02/23 (CGD1)

NEW JERSEY – RARITAN RIVER TO NEW BRUNSWICK - RARITAN RIVER – Notice of Temporary Deviation – The Coast Guard is temporarily modifying the operating schedule that governs the existing New Jersey Transit RR Bridge, mile 0.5, across Raritan River due to damaged gear system. Under this temporary deviation through **January 20, 2023**, the New Jersey Transit RR Bridge will open on Mondays and Fridays at 10:45 a.m. (Please call Stacy Hood or Joe McChesney to confirm the scheduled bridge openings). All other times, a minimum of 48 hours advance notice is required for bridge openings by calling Stacy Hood at 201-407-3418 or Joe McChesney at 201-241-1721. **From 9 a.m. on January 17, 2023 to 9 a.m. on January 19, 2023 the bridge need not open for the passage of vessels in order to replace bearings.** Mariners may also contact VTS New York at (718) 354-4088 to request openings or obtain current information regarding the bridge's operating schedule. The vertical clearance in the closed position is approx. 8 feet at MHW. Vessels that can transit under the closed span may do so at any time. Mariners are advised to plan accordingly and exercise extreme caution when transiting the area.

Chart 12332 LNM 02/23 (CGD1)

NEW JERSEY – RARITAN RIVER TO NEW BRUNSWICK - RARITAN RIVER – Deck and Structural Replacement – Deck and structural replacement at the New Jersey Turnpike (Basilone) Bridge across Raritan River at mile 10.2 will commence on May 26, 2022. A safe span will be installed under the bridge across the entire span which will reduce the vertical clearance by approximate 5ft. Please contact Daniel Weissman of D'Annunzio Group or Mike Norris of WSP via marine radio VHF-FM CH 13/16 or call 732-877-3894/732-934-7535 for bridge construction. This project will be completed by **May 26, 2025**. Mariners are advised to exercise caution when transiting the area.

Chart 12332 LNM 02/23 (CGD1)

Encl 4

NEW JERSEY – SANDY HOOK TO LITTLE EGG HARBOR – SHREWBURY RIVER – Bridge Replacement – Installation of temporary trestle to the S-32 (Rumson Road) Bridge over Shrewsbury River at mile 4.0 is in progress. There will be barge equipments operating IVO the bridge. From October 10, 2022 to October 7, 2023, navigation channel will be reduced from 75ft to 65ft due to two temporary cofferdams installation. For barge placement details, please contact Mike Rudolph at 908-814-8927 or via marine radio VHF-FM CH 13/16. This project will be completed by **March 17, 2025**. Mariners are advised to exercise caution when transiting the area.

Chart 12324 LNM 02/23 (CGD1)

REPORTED UNEXPLODED ORDNANCE (UXO)

Updated 1/11/2023

New information highlighted in Yellow

The Coast Guard advertises this information through local, Sector Broadcast Notice to Mariners (BNMs) and through the weekly, First Coast Guard District LNM. BNMs are additionally available directly to mariners by email sign-up at the CG Navigation Center Web Site ([Subscribe to Our RSS Feeds | Navigation Center \(uscg.gov\)](https://www.uscg.gov)). Once identified NOAA will then chart the UXO location so they are available on electronic navigation chart updates. Information on proper reporting and safety procedures for UXOs can be found at the following link: [Home - DENIX \(osd.mil\)](https://www.osd.mil)

RI- NARRAGANSETT BAY - WEST PASSAGE – UNEXPLODED ORDNANCE- UPDATE 9/2/2022

Sixteen (16) unexploded ordnances have been located via survey in Narragansett Bay – West Passage in positions:

- (1.) 41-27-7.68N 071-24-35.64W; (2.) 41-27-25.74N 071-24-38.94W; (3.) 41-27-33.60N 071-24-38.34W
- (4.) 41-24-49.80N 071-22-58.14W (5.) 41-26-40.32N 071-24-42.54W (6.) 41-26-34.44N 071-24-8.22W;
- (7.) 41-26-00.18N 071-24-30.48W; (8.) 41-28-00.96N 071-24-28.68W; (9.) 41-24-43.74N 071-214.44W;
- (10.) 41-24-56.52N 071-21-59.64W; (11.) 41-24-52.62N 071-23-43.62W; (12.) 41-27-38.880N 071-24-6.978W;
- (13.) 41-26-4.324N 071-24-30.591W; (14.) 41-27-36.236N 071-24-37.026N;
- (15.) 41-26-44.709N 071-24-38.974W; (16.) 41-24-45.927N 071-21-39.508W. Mariners are urged to avoid the ordnances and transit the area with caution.

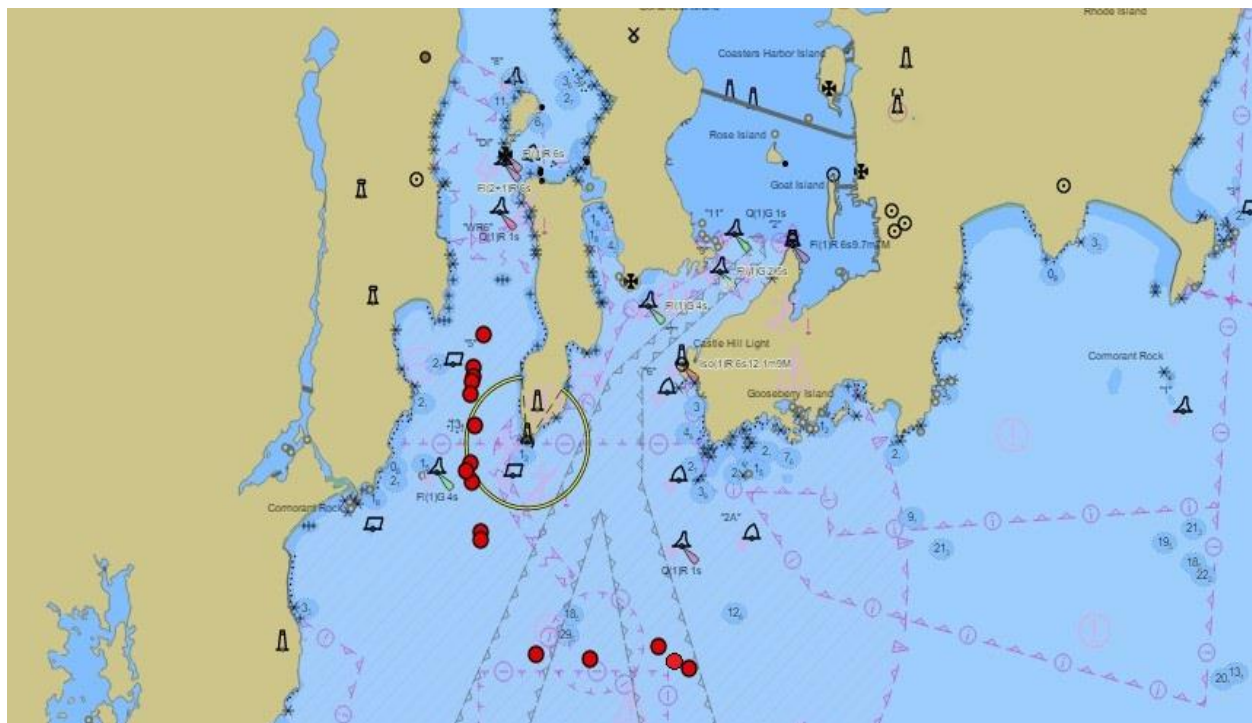

Chart 13223 LNM 27/22

ATLANTIC OCEAN- 22 MILES SOUTHEAST OF BLOCK ISLAND – UNEXPLODED ORDNANCE

An unexploded ordnance has been located via survey in 22 miles southeast of Block Island in position, 41-58-32.182N 071-11-13.534W, in approximately depth of 54 meters (see chartlet). Mariners are urged to avoid the ordnance and transit the area with caution.



Chart 13223 LNM 36/22

ATLANTIC OCEAN-SOUTH OF MARTHA’S VINEYARD

One unexploded ordnance has been located approximately 18NM south of Martha’s Vineyard in position 41-04.044N, 070-26.470W in approximately, 41 meters of water. Mariners are urged to avoid the ordnance and transit the area with caution.

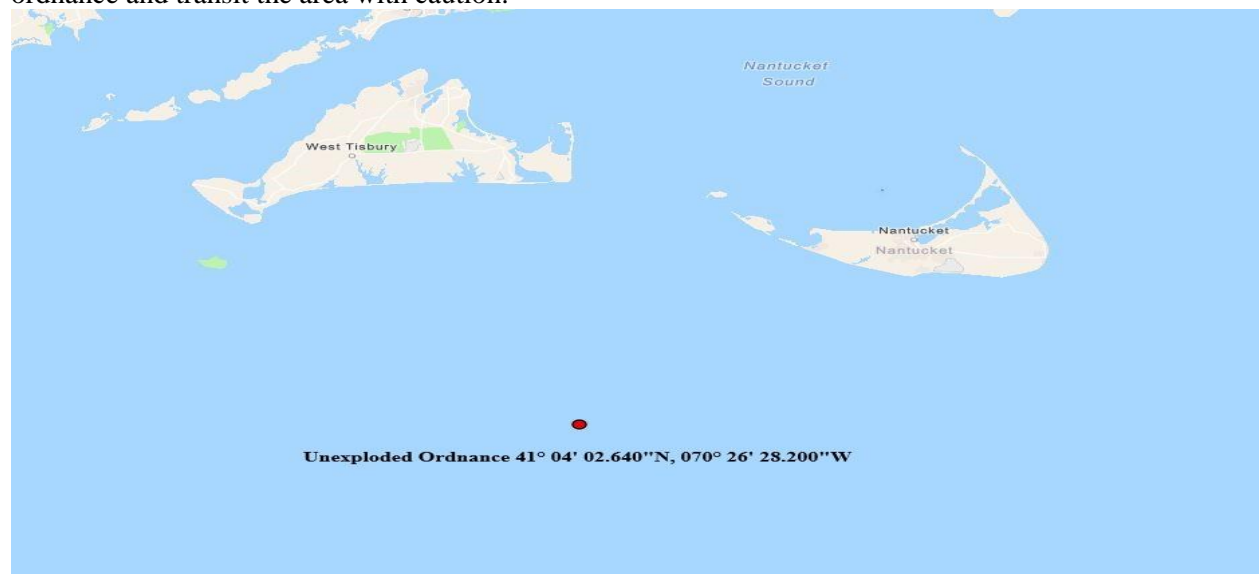

Chart 13006 LNM 27/22

Maritime Industry



During maritime operations (e.g., fishing, clamming or dredging), nets, bottom tending gear, and dredges may catch or dredge munitions from the ocean. Munitions pose a potential, but real danger to vessels and crews as well as to commercial and recreational divers.

Vessel crews often tell tales about catching suspicious items in a net or dredging gear. Lucky crews live to spin their own tales, while others become the subject of a tragic tale.

In July 1965, such a tragedy took place aboard the fishing vessel (*FV Snoopy*). The *FV Snoopy* was trawling for scallops off the coast of North Carolina when it caught a large cylinder in her net. A witness said he could clearly see a long round object swaying in the net amidstips, over the deck.

What happened next is unclear, but an explosion caused the loss of the *FV Snoopy* and eight of her crew.

What went wrong? Was it preventable? Could something have been done to save the *FV Snoopy* and her crew?

While all these questions were asked, no one but the *FV Snoopy*'s crew actually knows what happened. However, this tale is meaningful if others learn from it.

If you encounter or suspect you have encountered a munition at sea, follow the 3Rs of explosives safety (Recognize, Retreat, Report).



Unexploded ordnance recovered during dredging



A new torpedo (top) and a heavily corroded torpedo on the sea floor (bottom).



Recognize

The military has conducted live-fire training and combat operations at sea for centuries. Prior to 1970, the U.S. military and the militaries of other nations sea-disposed excess, obsolete and unserviceable munitions either en route to port or as part of a planned disposal. In 1970, militaries of the United States and other countries stopped the practice, now allowing it only during an emergency. Mariners should be prepared for an encounter with munitions during commercial operations, such as fishing, clamming or dredging. By following the 3Rs and using common sense, mariners will know what to do if they inadvertently recover a munition.

Munitions may be encountered anywhere, not just in charted hazard areas. Munitions that may be encountered include mines, torpedoes, depth charges, artillery shells, bombs and missiles. Munitions may contain explosives or chemical agents, both potentially posing serious dangers to a vessel and her crew.



Various recovered projectiles

- All munitions, including those that have been in the sea or fresh water for many years, should be considered extremely dangerous.
- In some cases, munitions that have been in water for a long time have become more sensitive.
- Whether encountered at sea or on land, munitions might explode when moved, disturbed, or handled.
- Munitions submerged in sea or fresh water for any length of time may:
 - Look new and be easy to identify;
 - Be heavily rusted or encrusted with sea growth and be difficult to identify.

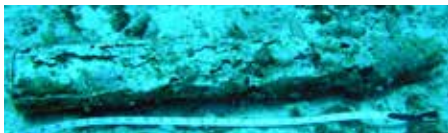

Projectile and cartridge case on sea floor

MUNITIONS ARE DESIGNED TO BE DANGEROUS

In support of its mission, the Department of Defense (DoD) designs military munitions to kill or seriously injure people, or destroy equipment (e.g., vessels). To protect yourself from the potential hazards associated with munitions, avoid

known disposal areas by heeding warnings on nautical charts and following the 3Rs of explosives safety (Recognize, Retreat, Report). (Note: This guide includes drawings and photos of some munitions to help crews recognize suspect munitions.)

CHEMICAL MUNITIONS AND CHEMICAL AGENTS

In the early 1900s, the Department of War, now DoD, developed chemical munitions to kill, seriously injure, or incapacitate an enemy. In the past, the United States and other countries sea-disposed chemical munitions and chemical agents in bulk containers, such as 55-gallon drums. As a result, some munitions or containers recovered from the sea may contain chemical agents.

Vessel crews should be alert for following signs that a chemical munition or chemical agents are present:

- Unusual odor from equipment or fish;
- Stinging sensations in the eyes;
- Burning or irritated skin;
- Presence of an oily liquid;
- Corroded containers or suspicious clay-like lumps.



Recovered chemical munition



Chemical munition recovered from clambed

IF YOU SUSPECT A CHEMICAL MUNITION OR AGENT IS PRESENT, ACT IMMEDIATELY TO PROTECT THE CREW AND VESSEL.

- Move all crew members upwind;
- Steam into the wind to carry any contaminants away from the crew;
- Close all doors and hatches;
- Shut down all ventilation systems;
- Flush the area thoroughly with water to wash suspect chemical agent overboard;
- Contact the U.S. Coast Guard (USCG) for immediate assistance;
- Do not steam into port, unless the USCG advises you to do so.



An aerial bomb prepared for shipping (above). An aerial bomb on the sea floor (below).



IF YOU SUSPECT CONTAMINATION BY CHEMICAL AGENTS

If you suspect a crew member has come in contact with a chemical agent, immediately:

- Remove any contaminated or potentially contaminated clothing and place it in a plastic bag (double bag, if possible) and seal it or just throw the clothing overboard. (Similar actions should be taken with contaminated or potentially contaminated tools.)
- Rinse the crew and the immediate area with large amounts of water. (If possible, use warm soapy water.)



Munitions on the sea floor

Every effort should be made to prevent the spread of chemical contamination. Chemical agent-contaminated clothing and tools may expose other crew members to chemical agent and spread the contamination to other areas on the vessel. Crew members should not work in areas known or suspected to be contaminated by chemical agent. Vessels that may have come in contact with chemical agents should not bring their catch ashore until the state's department of environmental health has determined it is safe to do so.

Retreat

Because munitions present a potential explosive or chemical agent hazard, they should not be moved, disturbed or handled. However at sea, and depending on the circumstances, specific action may be required to protect the vessel and her crew.

- Avoid bringing munitions (or suspect munitions) onboard, whenever possible.
- If a munition is ensnared or fouled in gear, retreat by carefully returning the munition to the water or by cutting away the gear.
- If the munition cannot be carefully returned to the water, secure it onboard, and move the crew upwind and as far away from the munition as possible.
- Limit the number of crew members securing the munition, and avoid bumping or dropping the munition. Remember that each action carries some risk!



A new 5-inch 38 caliber projectile (above). Recovered 5-inch 38 caliber projectiles (below).



Munitions Recovered, but Not Yet Onboard

- Immediately stop all operations;
- Do not bring the munition or gear containing it onboard, if possible;
- Do not allow the munition to come or remain alongside the vessel where wave action could cause the munition to contact the hull;
- If a munition is caught in the gear, but has not been brought onboard, try to lower it safely back into the water, note the position and report it to the USCG. In:
 - Shallow water (less than 130 feet), lower the munition to the bottom, buoy off the net or dredge recovery lines and remain in the area while awaiting assistance.
 - Deep water, stream the munition as far aft as possible, maintain steerageway, as necessary and remain in the immediate area while awaiting assistance.

Munitions Recovered and Brought Onboard

If gear is brought over the deck with a munition or suspected munition, but it remains suspended and it can be safely secured in place or nearby, immediately:

- Secure the munition with guy lines to prevent movement;
- Keep the crew upwind and away from the area.

If a suspect munition is brought onboard:

- Keep crew members upwind and as far away as possible.
- Minimize handling, and decide whether it is safest to:
 - Carefully return it to the water, or
 - Retain it onboard.

If returned to the water, note and report position to USCG.

If retained onboard:

- Keep the crew upwind and away from the munition.
- Minimize handling, and avoid disturbing (hitting, dropping or bending) any part of the munition;
- Secure the munition on deck with lines and/or by chocking it to prevent movement, but do this as far away as possible from heat sources, vibrations and the crew;
- Cover the munition with a tarp or wet cloth to reduce the potential for:
 - Deterioration of metal parts and release of its fill;
 - Explosives to dry out and become sensitive to shock.
- Request assistance (Channel 16 - 156.800 MHz).



A new rifle grenade (above). A recovered grenade (below). Item is about four inches long.

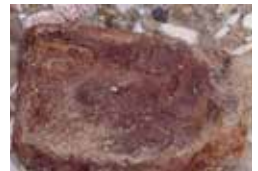

NEVER BRING A MUNITION INTO PORT, UNLESS DIRECTED TO DO SO

Report

Careful observation and accurate reporting of the situation is necessary, so that proper instructions and assistance can be provided. However, never attempt to clean or open a munition to get a better description or tamper with a munition in any way. Information you provide may be combined with other reports to produce a Notice to Mariners and/or update nautical charts.

When a munition or suspect munition is encountered, the vessel's captain should notify the USCG (Channel 16 - 156.800 MHz) and provide the below information, as soon as possible. (Note: If a munition is encountered while in port, call 911.) Report:



Floating mine washed ashore

- The vessel's position (use World Geodetic System 1984 [WGS-84] for reporting). If the exact position is unknown, give approximate coordinates, or a range and bearing from a charted feature.
- The activity (e.g., fishing, clamming, dredging) being conducted when the munition was encountered.
- A general description of the munition's key features (i.e., size, shape, fins, markings) and overall condition, if observed or known.
- Any unusual odors.
- The action taken (e.g., secured munition on deck, munition carefully returned to water, washed off deck where munition was placed) to protect the crew.
- If the munition was returned to the water, provide:
 - The position where it was returned to the water: the water depth, buoys or markings used, if any; and whether the location is near or within a charted disposal area;
 - A description, if appropriate, of any entanglement (e.g., net, dredge);
 - A description of surface or sub-surface structures within 1,000 yards.

THE US COAST GUARD WILL NOTIFY AN EXPLOSIVE ORDNANCE DISPOSAL UNIT TO ARRANGE FOR SUPPORT.

DEPTH CHARGES

Length 28" / Diameter 18" to 25"

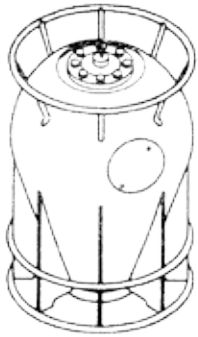

DEPTH BOMB

Length 50" to 59" / Diameter 15" to 18"

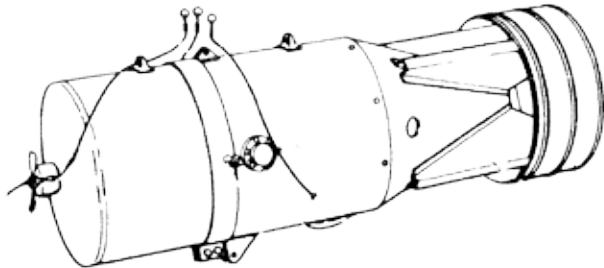

PRACTICE DEPTH CHARGES



PROJECTED ANTI-SUBMARINE-WARFARE WEAPONS

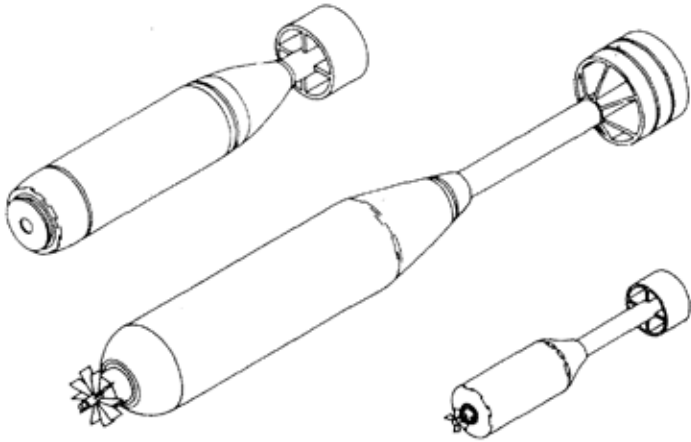

REPRESENTATIVE TORPEDOES

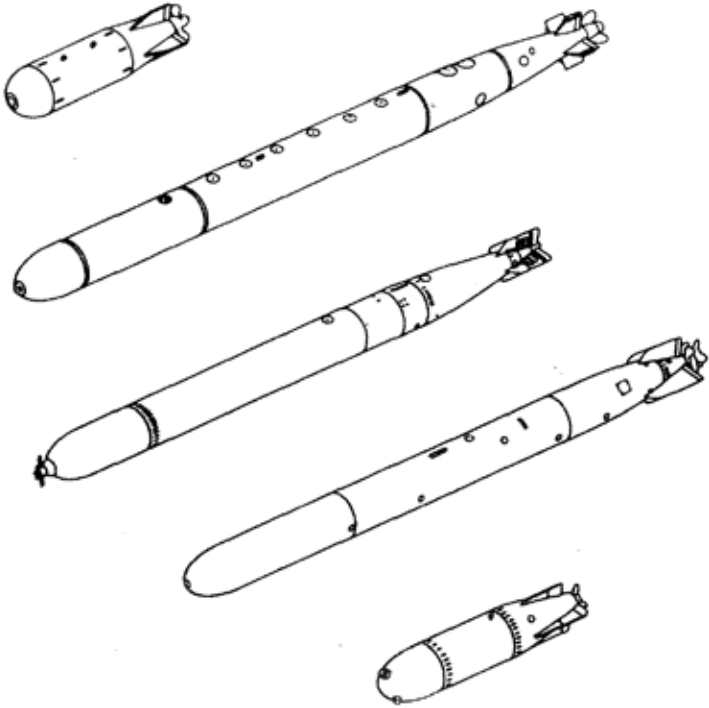

MISCELLANEOUS MINE FLOATS

Length 10" to 24"

Diameter 12" to 18"

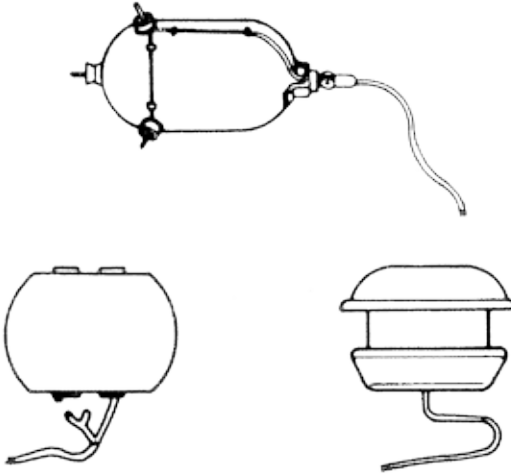

PROJECTILES

Lengths 20 mm to 16"

3" to 5" in Diameter (Typically)

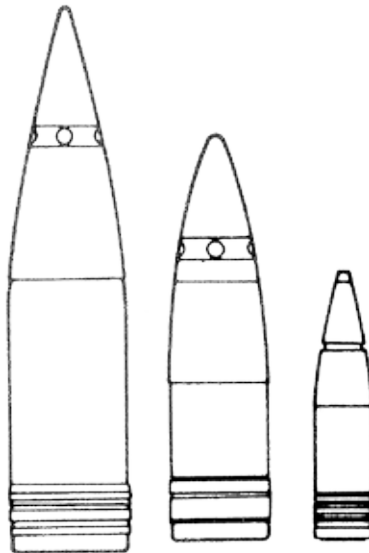

AERIAL BOMBS

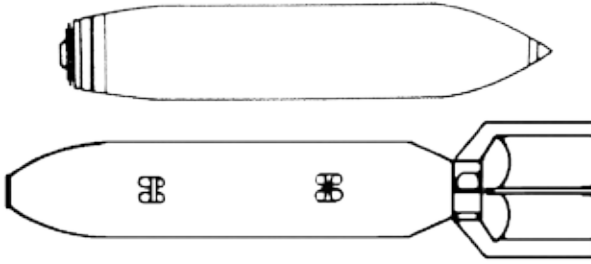

Bomb Body Lengths 39" to 97"

Diameter 7" to 19"

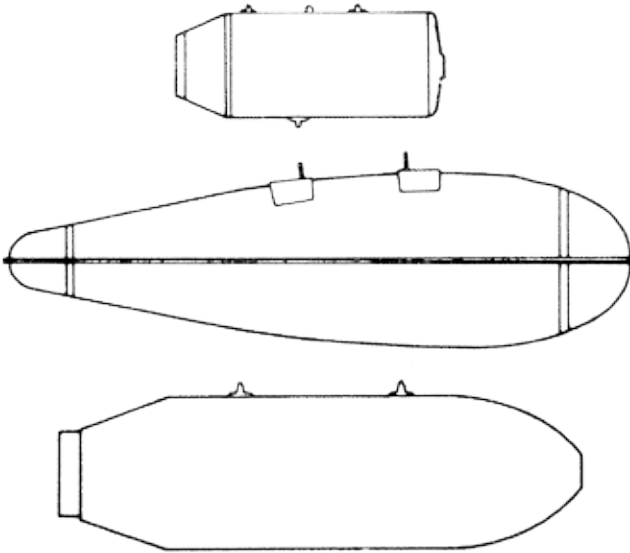

MARKERS AND SIGNALS

Lengths 10" to 18" (Approximately)

Diameter 2" to 5" (Approximately)

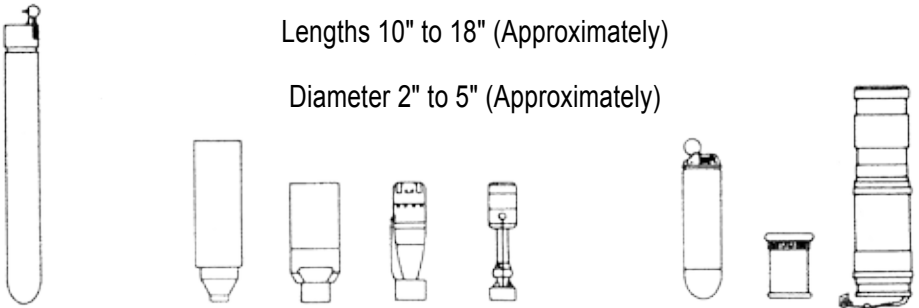

Don't Forget

- Munitions are dangerous and may not be easily recognizable!
- Avoid operational and former military ranges, and disposal areas!
- Do not bring munitions on-board!
- Never bring a munition into port, unless directed to do so by USCG!

Follow the 3Rs

Recognize

When you may have encountered a munition and that munitions are dangerous.

Retreat

If you know or suspect you have encountered a munition, carefully return it to the water or secure it and keep the crew away from the immediate area.

Report

Immediately notify the USCG of the vessel's or munition's location and provide a description of the munition.

Emergency contacts:

- In port: Call 911
- At sea: Use Channel 16 (156.800 MHz)



(Insert contact information here)

For additional information call
U.S. Army Technical Center for Explosives Safety
at (918) 420-8919

or see

the US Army's UXO Safety Education website
www.denix.osd.mil/uxo



ATTENTION ALL BOATERS: SLOW DOWN TO 10 KNOTS OR LESS FOR RIGHT WHALES



Red Areas = Annual Seasonal Management Area (SMA): 10 knots or less required for boats 65 feet and bigger. These speeds are also recommended for smaller boats.



Yellow Areas = where right whales have been sighted (* Dynamic Management Area) or heard. Recommended slow down zones for ALL vessels.



If a Slow Zone overlaps with a SMA, mandatory speed reductions are required.